

Using ADOBE® PHOTOSHOP® CS4

© 2008 Adobe Systems Incorporated. All rights reserved.

Using Adobe® Photoshop® CS4 for Windows® and Mac OS

If this guide is distributed with software that includes an end user agreement, this guide, as well as the software described in it, is furnished under license and may be used or copied only in accordance with the terms of such license. Except as permitted by any such license, no part of this guide may be reproduced, stored in a retrieval system, or transmitted, in any form or by any means, electronic, mechanical, recording, or otherwise, without the prior written permission of Adobe Systems Incorporated. Please note that the content in this guide is protected under copyright law even if it is not distributed with software that includes an end user license agreement.

The content of this guide is furnished for informational use only, is subject to change without notice, and should not be construed as a commitment by Adobe Systems Incorporated. Adobe Systems Incorporated assumes no responsibility or liability for any errors or inaccuracies that may appear in the informational content contained in this guide.

Please remember that existing artwork or images that you may want to include in your project may be protected under copyright law. The unauthorized incorporation of such material into your new work could be a violation of the rights of the copyright owner. Please be sure to obtain any permission required from the copyright owner.

Any references to company names in sample templates are for demonstration purposes only and are not intended to refer to any actual organization.

Adobe, the Adobe logo, Adobe Garamond, Adobe Premiere, AdobePS, Acrobat, Acrobat Capture, After Effects, Cafilisch Script, Creative Suite, Distiller, Dreamweaver, Fireworks, Flash, FrameMaker, GoLive, Illustrator, ImageReady, InCopy, InDesign, Lightroom, PageMaker, Photomerge, Photoshop, PostScript, Streamline, and Version Cue are either registered trademarks or trademarks of Adobe Systems Incorporated in the United States and/or other countries.

Microsoft, OpenType, Windows, and Windows Vista are either registered trademarks or trademarks of Microsoft Corporation in the United States and/or other countries. Apple, Mac, Macintosh, and Mac OS are trademarks of Apple Inc., registered in the U.S. and other countries. IBM and OS/2 are trademarks of International Business Machines Corporation in the United States, other countries, or both. Java is a trademark or registered trademark of Sun Microsystems, Inc. in the United States and other countries. Intel is a trademark or registered trademark of Intel Corporation or its subsidiaries in the U.S. and other countries. Helvetica is a registered trademark of Heidelberg Druckmaschinen AG exclusively licensed through Linotype Library GmbH, and may be registered in certain jurisdictions. All other trademarks are the property of their respective owners.

The Spelling portion of this product is based on Proximity Linguistic Technology. The Proximity Hyphenation System ©1989 All rights reserved Proximity Technology, Inc. Proximity and Linguibase are registered trademarks of Proximity Technology Inc.

This product includes software developed by the Apache Software Foundation (www.apache.org).

This product contains either BISAFE and/or TIPEM software by RSA Data Security, Inc.

This product includes cryptographic software written by Eric Young (ey@cryptosoft.com).

This software is based in part on the work of the Independent JPEG Group.

© 1994 Hewlett Packard Company.

Portions of this code are licensed from Apple Inc. under the terms of the Public Source License Version 2. The source code version of the licensed code and the license are available at www.opensource.apple.com/apsl.

PANTONE® Colors displayed in the software application or in the user documentation may not match PANTONE-identified standards. Consult current PANTONE Color Publications for accurate color. PANTONE® and other Pantone, Inc. trademarks are the property of Pantone, Inc. © Pantone, Inc., 2006. Pantone, Inc. is the copyright owner of color data and/or software which are licensed to Adobe Systems Incorporated to distribute for use only in combination with Adobe Photoshop. PANTONE Color Data and/or Software shall not be copied onto another disk or into memory unless as part of the execution of Adobe Photoshop.

e_Db is a licensed Product from Simple Software Solutions, Inc.

Portions include technology used under license from Autonomy, and are copyrighted.

This Program was written with MacApp®: ©1985-1988 Apple Computer, Inc. APPLE COMPUTER, INC. MAKES NO WARRANTIES WHATSOEVER, EITHER EXPRESS OR IMPLIED, REGARDING THIS PRODUCT, INCLUDING WARRANTIES WITH RESPECT TO ITS MERCHANTABILITY OR ITS FITNESS FOR ANY PARTICULAR PURPOSE. The MacApp software is proprietary to Apple Computer, Inc. and is licensed to Adobe for distribution only for use in combination with Adobe Photoshop.

Portions contributed by Focoltone Color Matching System.

Portions contributed by Dainippon Ink and Chemicals, Inc.

Flash video compression and decompression is powered by On2 TrueMotion video technology. © 1992-2005 On2 Technologies, Inc. All Rights Reserved. <http://www.on2.com>.

This product includes software developed by the OpenSymphony Group (<http://www.opensymphony.com/>).

Portions contributed by Nellymoser, Inc. (www.nellymoser.com).

**Sorenson
Spark.**

Sorenson Spark™ video compression and decompression technology licensed from Sorenson Media, Inc.

MPEG Layer-3 audio compression technology licensed by Fraunhofer IIS and THOMSON multimedia. (<http://www.iis.fhg.de/amm/>)

Copyright © 1995-2002 Opera Software ASA and its supplier. All rights reserved.

This product includes software developed by the IronSmith Project (www.ironsmith.org)

Notice to U.S. Government End Users: The Software and Documentation are "Commercial Items," as that term is defined at 48 C.F.R. §2.101, consisting of "Commercial Computer Software" and "Commercial Computer Software Documentation," as such terms are used in 48 C.F.R. §12.212 or 48 C.F.R. §227.7202, as applicable. Consistent with 48 C.F.R. §12.212 or 48 C.F.R. §§227.7202-1 through 227.7202-4, as applicable, the Commercial Computer Software and Commercial Computer Software Documentation are being licensed to U.S. Government end users (a) only as Commercial Items and (b) with only those rights as are granted to all other end users pursuant to the terms and conditions herein. Unpublished-rights reserved under the copyright laws of the United States. Adobe agrees to comply with all applicable equal opportunity laws including, if appropriate, the provisions of Executive Order 11246, as amended, Section 402 of the Vietnam Era Veterans Readjustment Assistance Act of 1974 (38 USC 4212), and Section 503 of the Rehabilitation Act of 1973, as amended, and the regulations at 41 CFR Parts 60-1 through 60-60, 60-250, and 60-741. The affirmative action clause and regulations contained in the preceding sentence shall be incorporated by reference.

Adobe Systems Incorporated, 345 Park Avenue, San Jose, California 95110, USA.

Contents

Chapter 1: Resources

Activation and registration	1
Help and support	2
Services, downloads, and extras	2
What's new?	4

Chapter 2: Workspace

Workspace basics	6
Panels and menus	14
Tools	18
Viewing images	27
Rulers, the grid, and guides	36
Presets, Plug-ins, and Preferences	41
Undo and history panel	45
Memory and performance	50
Managing connections	52

Chapter 3: Opening and importing images

Image essentials	54
Image size and resolution	56
Acquiring images from cameras and scanners	63
Creating, opening, and importing images	64
Placing files	69
High dynamic range images	71

Chapter 4: Camera Raw

Introduction to Camera Raw	79
Navigating, opening, and saving images	84
Making color and tonal adjustments in Camera Raw	87
Modifying images with Camera Raw	93
Making local adjustments in Camera Raw	96
Camera Raw settings	99

Chapter 5: Color

About color	103
Color modes	106
Converting between color modes	108
Choosing colors	114
Kuler panel	123

Chapter 6: Color management

Understanding color management	126
Keeping colors consistent	128
Color-managing imported images	132

Color-managing documents for online viewing	133
Proofing colors	134
Color-managing documents when printing	137
Working with color profiles	139
Color settings	144
Chapter 7: Color and tonal adjustments	
Viewing histograms and pixel values	149
Understanding color adjustments	155
Adjusting image color and tone	161
Targeting images for press	175
Matching, replacing, and mixing colors	177
Making quick image adjustments	183
Applying special color effects to images	189
Chapter 8: Retouching and transforming	
Adjusting crop, rotation, and canvas	192
Retouching and repairing images	197
Correcting image distortion and noise	206
Adjusting image sharpness and blur	209
Transforming objects	214
Content-aware scaling	220
Liquify filter	222
Vanishing Point	228
Create panoramic images	243
Chapter 9: Selecting and masking	
Making selections	247
Adjusting pixel selections	255
Moving and copying selected pixels	261
Deleting and extracting objects	265
Channels	265
Saving selections and using masks	269
Channel calculations	276
Chapter 10: Layers	
Layer Basics	279
Selecting, grouping, and linking layers	284
Moving, stacking, and locking layers	285
Managing layers	291
Setting opacity and blending	294
Layer effects and styles	298
Adjustment and fill layers	307
Nondestructive editing	309
Layer comps	317
Masking layers	319

Chapter 11: Painting

Painting tools 328
 Brush presets 333
 Creating and modifying brushes 335
 Blending modes 346
 Gradients 350
 Filling and stroking selections, layers, and paths 354
 Creating and managing patterns 357

Chapter 12: Drawing

Drawing vector graphics 359
 Drawing shapes 360
 Drawing with the Pen tools 364
 Managing paths 370
 Editing paths 372
 Converting between paths and selection borders 380
 Adding color to paths 381

Chapter 13: Filters

Filter basics 384
 Filter effects reference 389
 Applying specific filters 397
 Add Lighting Effects 400

Chapter 14: Type

Creating type 404
 Editing text 407
 Formatting characters 411
 Fonts 415
 Line and character spacing 419
 Scaling and rotating type 422
 Formatting paragraphs 423
 Creating type effects 429
 Asian type 434

Chapter 15: Saving and exporting images

Saving images 440
 Saving PDF files 444
 Saving and exporting files in other formats 452
 File formats 457
 Metadata and notes 464
 Adding and viewing Digimarc copyright protection 465
 Placing Photoshop images in other applications 468

Chapter 16: Printing

Printing from Photoshop 473
 Printing with color management 477
 Printing images to a commercial printing press 481

Printing duotones	488
Printing spot colors	491
Chapter 17: Web graphics	
Working with web graphics	495
Slicing web pages	497
Modifying slices	500
Slice output options	504
Optimizing images	506
Web graphics optimization options	512
Output settings for web graphics	524
Chapter 18: Video and animation	
Video and animation in Photoshop	527
Creating images for video	532
Importing video files and image sequences (Photoshop Extended)	537
Interpreting video footage (Photoshop Extended)	539
Painting frames in video layers (Photoshop Extended)	540
Editing video and animation layers (Photoshop Extended)	543
Creating frame animations	547
Creating timeline animations (Photoshop Extended)	554
Previewing video and animations	560
Saving and exporting video and animations	563
Chapter 19: 3D and technical imaging	
3D overview (Photoshop Extended)	571
3D editing and output (Photoshop Extended)	584
DICOM files (Photoshop Extended)	597
Measurement (Photoshop Extended)	601
Counting objects in an image (Photoshop Extended)	607
Photoshop and MATLAB (Photoshop Extended)	609
Image Stacks (Photoshop Extended)	611
Chapter 20: Automating tasks	
Automating with actions	614
Creating actions	618
Processing a batch of files	622
Scripting	626
Creating data-driven graphics	627
Chapter 21: Optional plug-ins	
Picture packages and contact sheets	633
Creating web photo galleries	637
Extract an object from its background	643
Generate a pattern using the Pattern Maker	645
Import an image using the TWAIN interface	647

Chapter 22: Keyboard shortcuts

Customizing keyboard shortcuts 648

Default keyboard shortcuts 649

Index 674

Chapter 1: Resources

Before you begin working with your software, take a few moments to read an overview of activation and the many resources available to you. You have access to instructional videos, plug-ins, templates, user communities, seminars, tutorials, RSS feeds, and much more.

Activation and registration

Help with installation

For help with installation issues, see the Installation Support Center at www.adobe.com/go/cs4install.

License activation

During the installation process, your Adobe software contacts Adobe to complete the license activation process. No personal data is transmitted. For more information on product activation, visit the Adobe website at www.adobe.com/go/activation.

A single-user retail license activation supports two computers. For example, you can install the product on a desktop computer at work and on a laptop computer at home. If you want to install the software on a third computer, first deactivate it on one of the other two computers. Choose Help > Deactivate.

Register

Register your product to receive complimentary installation support, notifications of updates, and other services.

- ❖ To register, follow the on-screen instructions in the Registration dialog box, which appears after you install the software.



If you postpone registration, you can register at any time by choosing Help > Registration.

Adobe Product Improvement Program

After you use your Adobe software a certain number of times, a dialog box may appear asking whether you want to participate in the Adobe Product Improvement Program.

If you choose to participate, data about your use of Adobe software is sent to Adobe. No personal information is recorded or sent. The Adobe Product Improvement Program only collects information about which features and tools you use and how often you use them.

You can opt in to or out of the program at any time:

- To participate, choose Help > Adobe Product Improvement Program and click Yes, Participate.
- To stop participating, choose Help > Adobe Product Improvement Program and click No, Thank You.

ReadMe

A ReadMe file for your software is available online and on the installation disc. Open the file to read important information about topics such as the following:

- System requirements
- Installation (including uninstalling the software)
- Activation and registration
- Font installation
- Troubleshooting
- Customer support
- Legal notices

Help and support

Community Help

Community Help is an integrated environment on adobe.com that gives you access to community-generated content moderated by Adobe and industry experts. Comments from users help guide you to an answer. Search Community Help to find the best content on the web about Adobe products and technologies, including these resources:

- Videos, tutorials, tips and techniques, blogs, articles, and examples for designers and developers.
- Complete online Help, which is updated regularly and is more complete than the Help delivered with your product. If you are connected to the Internet when you access Help, you automatically see the complete online Help rather than the subset delivered with your product.
- All other content on Adobe.com, including knowledgebase articles, downloads and updates, Developer Connection, and more.

Use the help search field in your product's user interface to access Community Help. For a video of Community Help, see www.adobe.com/go/lrvid4117_xp.

Other resources

Printed versions of the complete online Help are available for the cost of shipping and handling at www.adobe.com/go/store. Online Help also includes a link to the complete, updated PDF version of Help.

Visit the Adobe Support website at www.adobe.com/support to learn about free and paid technical support options.

Services, downloads, and extras

You can enhance your product by integrating a variety of services, plug-ins, and extensions in your product. You can also download samples and other assets to help you get your work done.

Adobe creative online services

Adobe® Creative Suite® 4 includes new online features that bring the power of the web to your desktop. Use these features to connect with the community, collaborate, and get more from your Adobe tools. Powerful creative online services let you complete tasks ranging from color matching to data conferencing. The services seamlessly integrate with desktop applications so you can quickly enhance existing workflows. Some services offer full or partial functionality when you're offline too.

Visit [Adobe.com](http://adobe.com) to learn more about available services. Some Creative Suite 4 applications include these initial offerings:

Kuler™ panel Quickly create, share, and explore color themes online.

Adobe® ConnectNow Collaborate with dispersed working teams over the web, sharing voice, data, and multimedia.

Resource Central Instantly access tutorials, sample files, and extensions for Adobe digital video applications.

For information on managing your services, see the Adobe website at http://www.adobe.com/go/learn_creativeservices_en.

Adobe Exchange

Visit the Adobe Exchange at www.adobe.com/go/exchange to download samples as well as thousands of plug-ins and extensions from Adobe and third-party developers. The plug-ins and extensions can help you automate tasks, customize workflows, create specialized professional effects, and more.

Adobe downloads

Visit www.adobe.com/go/downloads to find free updates, tryouts, and other useful software.

Adobe Labs

Adobe Labs at www.adobe.com/go/labs gives you the opportunity to experience and evaluate new and emerging technologies and products from Adobe. At Adobe Labs, you have access to resources such as these:

- Prerelease software and technologies
- Code samples and best practices to accelerate your learning
- Early versions of product and technical documentation
- Forums, wiki-based content, and other collaborative resources to help you interact with like-minded users.

Adobe Labs fosters a collaborative software development process. In this environment, customers quickly become productive with new products and technologies. Adobe Labs is also a forum for early feedback. The Adobe development teams use this feedback to create software that meets the needs and expectations of the community.

Adobe TV

Visit Adobe TV at <http://tv.adobe.com> to view instructional and inspirational videos.

Extras

The installation disc contains a variety of extras to help you make the most of your Adobe software. Some extras are installed on your computer during the setup process; others are located on the disc.

To view the extras installed during the setup process, navigate to the application folder on your computer.

- Windows®: *[startup drive]\Program Files\Adobe\[Adobe application]*
- Mac OS®: *[startup drive]/Applications/[Adobe application]*

To view the extras on the disc, navigate to the Goodies folder in your language folder on the disc. Example:

- */English/Goodies/*

What's new?

New Photoshop Features

Adjustments panel

Quickly access the controls you need to non-destructively adjust image color and tone in the Adjustments panel. Includes on-image controls and presets in one location. See “[Adjustments panel overview](#)” on page 156.

Masks panel

Quickly create precise masks in the Masks panel. The Masks panel offers tools and options for creating editable pixel- and vector-based masks, adjusting mask density and feathering, and selecting non-contiguous objects. See “[Masking layers](#)” on page 319.

Advanced compositing

Create more accurate composites using the enhanced Auto-Align Layers command, and use the spherical alignment to create 360-degree panoramas. The enhanced Auto-Blend Layers command smoothly blends color and shading, and extends your depth of field by correcting vignettes and lens distortion. See “[Retouching and transforming](#)” on page 192.

Canvas rotation

Click to smoothly turn your canvas for nondestructive viewing at any desired angle. See “[Adjusting crop, rotation, and canvas](#)” on page 192.

Smoother panning and zooming

Gracefully navigate to any area of an image with smoother panning and zooming. Maintain clarity as you zoom to individual pixels, and easily edit at the highest magnification with the new Pixel Grid. See “[Viewing images](#)” on page 27.

Better raw processing in Camera Raw

Apply corrections to specific areas of an image using the Camera Raw 5.0 plug-in, enjoy superior conversion quality, and apply postcrop vignettes to images. See “[Camera Raw](#)” on page 79.

Improved Lightroom workflow

Enhanced integration between Photoshop CS4 and Photoshop® Lightroom® 2 allows you to open photos from Lightroom in Photoshop and seamlessly roundtrip back to Lightroom. Automatically merge photos from Lightroom into panoramas, open as HDR images, or open as multilayer Photoshop file.

Efficient file management with Adobe® Bridge CS4

Enjoy efficient visual asset management with Adobe Bridge CS4, which features faster startup, workspaces that suit the task at hand, and the ability to create web galleries and Adobe PDF contact sheets. See *Working with Adobe Bridge*.

Powerful printing options

The Photoshop CS4 print engine provides tight integration with all the most popular printers, the capability to preview out-of-gamut image areas, and support for 16-bit printing on Mac OS. See “[Printing](#)” on page 473.

3D acceleration

Enable OpenGL Drawing to accelerate 3D operations. See “[About OpenGL](#)” on page 572.

Comprehensive 3D tools

Paint directly on 3D models, wrap 2D images around 3D shapes, convert gradient shapes to 3D objects, add depth to layers and text, and enjoy exporting to common 3D formats. See “[3D and technical imaging](#)” on page 571.

Higher performance on very large images (Windows only)

Work faster with very large images by taking advantage of additional RAM. (Requires a 64-bit computer with a 64-bit version of Microsoft Windows Vista®).

Chapter 2: Workspace

The Adobe® Photoshop® CS4 workspace is arranged to help you focus on creating and editing images. The workspace includes menus and a variety of tools and panels for viewing, editing, and adding elements to your images.

For a video on editing and merging images from Lightroom, see www.adobe.com/go/lrvid4001_ps.

Workspace basics

Workspace overview

You create and manipulate your documents and files using various elements, such as panels, bars, and windows. Any arrangement of these elements is called a *workspace*. The workspaces of the different applications in Adobe® Creative Suite® 4 share the same appearance so that you can move between the applications easily. You can also adapt each application to the way you work by selecting from several preset workspaces or by creating one of your own.

Although the default workspace layout varies in different products, you manipulate the elements much the same way in all of them.

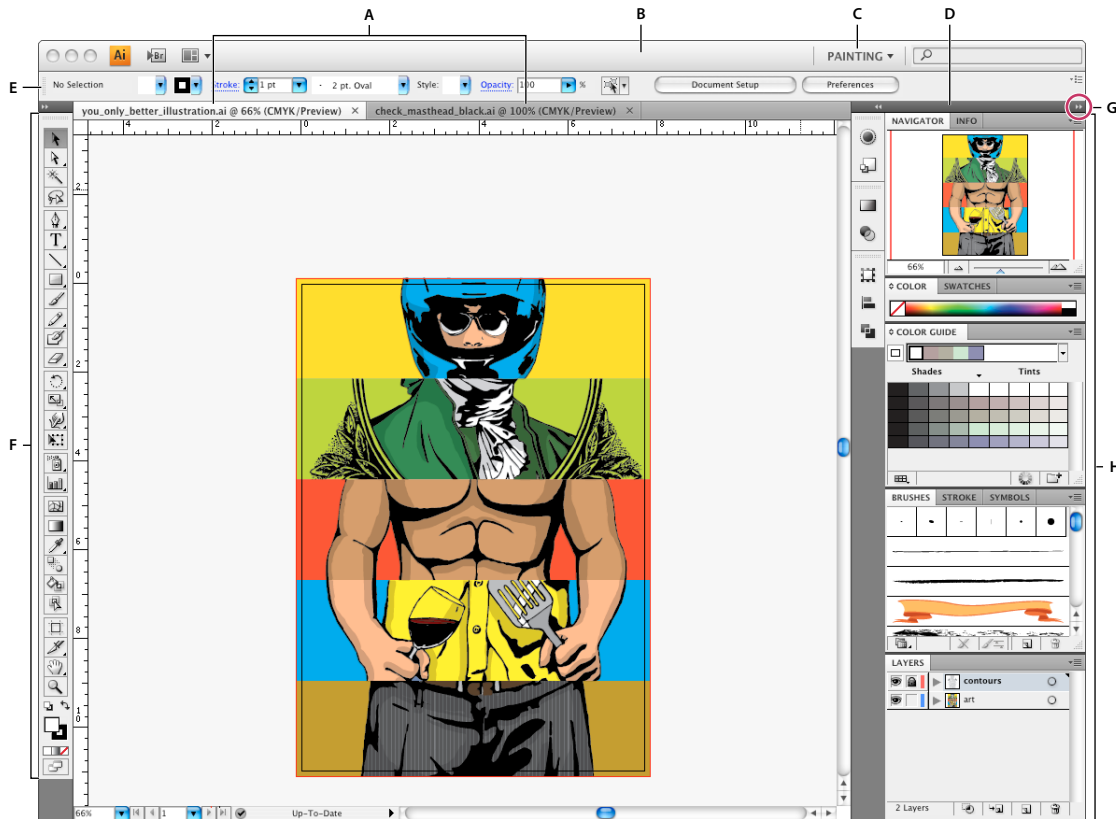

Default Illustrator workspace

A. Tabbed Document windows B. Application bar C. Workspace switcher D. Panel title bar E. Control panel F. Tools panel G. Collapse To Icons button H. Four panel groups in vertical dock

- The *Application bar* across the top contains a workspace switcher, menus (Windows only), and other application controls. On the Mac for certain products, you can show or hide it using the Window menu.
- The *Tools panel* contains tools for creating and editing images, artwork, page elements, and so on. Related tools are grouped.
- The *Control panel* displays options for the currently selected tool. The Control panel is also known as the options bar in Photoshop. (Adobe Flash®, Adobe Dreamweaver®, and Adobe Fireworks® have no Control panel.)
- Flash, Dreamweaver, and Fireworks have a *Property inspector* that displays options for the currently selected element or tool.
- The *Document window* displays the file you're working on. Document windows can be tabbed and, in certain cases, grouped and docked.
- *Panels* help you monitor and modify your work. Examples include the Timeline in Flash, the Layers panel in Adobe Photoshop®, and the CSS Styles panel in Dreamweaver. Panels can be grouped, stacked, or docked.

- On the Mac, the *Application frame* groups all the workspace elements in a single, integrated window that lets you treat the application as a single unit. When you move or resize the Application frame or any of its elements, all the elements within it respond to each other so none overlap. Panels don't disappear when you switch applications or when you accidentally click out of the application. If you work with two or more applications, you can position each application side by side on the screen or on multiple monitors. If you prefer the traditional, free-form user interface of the Mac, you can turn off the Application frame. In Adobe Illustrator®, for example, select Window > Application Frame to toggle it on or off. (In Flash, the Application frame is on permanently. Dreamweaver does not use an Application frame.)

Hide or show all panels

- (Illustrator, Adobe InCopy®, Adobe InDesign®, Photoshop, Fireworks) To hide or show all panels, including the Tools panel and Control panel, press Tab.
- (Illustrator, InCopy, InDesign, Photoshop) To hide or show all panels except the Tools panel and Control panel, press Shift+Tab.

 You can temporarily display hidden panels if Auto-Show Hidden Panels is selected in Interface preferences. It's always on in Illustrator. Move the pointer to the edge of the application window (Windows®) or to the edge of the monitor (Mac OS®) and hover over the strip that appears.

- (Flash, Dreamweaver, Fireworks) To hide or show all panels, press F4.

Display panel options

- ❖ Click the panel menu icon  in the upper-right corner of the panel.

 You can open a panel menu even when the panel is minimized.

(Illustrator) Adjust panel brightness

- ❖ In User Interface preferences, move the Brightness slider. This control affects all panels, including the Control panel.

Reconfigure the Tools panel

You can display the tools in the Tools panel in a single column, or side by side in two columns. (This feature is not available in the Tools panel in Fireworks and Flash.)

 In InDesign and InCopy, you also can switch from single-column to double-column (or single-row) display by setting an option in Interface preferences.

- ❖ Click the double arrow at the top of the Tools panel.

Manage windows and panels

You can create a custom workspace by moving and manipulating Document windows and panels. You can also save workspaces and switch among them.

Note: The following examples use Photoshop for demonstration purposes. The workspace behaves the same in all the products.

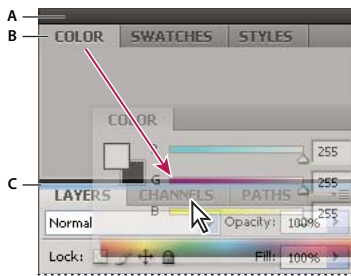

Narrow blue drop zone indicates Color panel will be docked on its own above the Layers panel group.
 A. Title bar B. Tab C. Drop zone

 In Photoshop, you can change the font size of the text in the Control panel, in the panels, and in tool tips. Choose a size from the UI Font Size menu in Interface preferences.

Manage Document windows

When you open more than one file, the Document windows are tabbed.

- To rearrange the order of tabbed Document windows, drag a window's tab to a new location in the group.
- To undock a Document window from a group of windows, drag the window's tab out of the group.
- To dock a Document window to a separate group of Document windows, drag the window into the group.

Note: Dreamweaver does not support docking and undocking Document windows. Use the Document window's Minimize button to create floating windows.

- To create groups of stacked or tiled documents, drag the window to one of the drop zones along the top, bottom, or sides of another window. You can also select a layout for the group by using the Layout button on the Application bar.

Note: Some products do not support this functionality. However, your product may have Cascade and Tile commands in the Window menu to help you lay out your documents.

- To switch to another document in a tabbed group when dragging a selection, drag the selection over the document's tab for a moment.

Note: Some products do not support this functionality.

Dock and undock panels

A *dock* is a collection of panels or panel groups displayed together, generally in a vertical orientation. You dock and undock panels by moving them into and out of a dock.

Note: Docking is not the same as stacking. A *stack* is a collection of floating panels or panel groups, joined top to bottom.

- To dock a panel, drag it by its tab into the dock, at the top, bottom, or in between other panels.
- To dock a panel group, drag it by its title bar (the solid empty bar above the tabs) into the dock.
- To remove a panel or panel group, drag it out of the dock by its tab or title bar. You can drag it into another dock or make it free-floating.

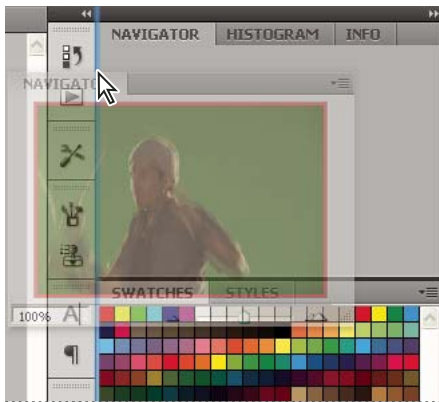

Navigator panel being dragged out to new dock, indicated by blue vertical highlight

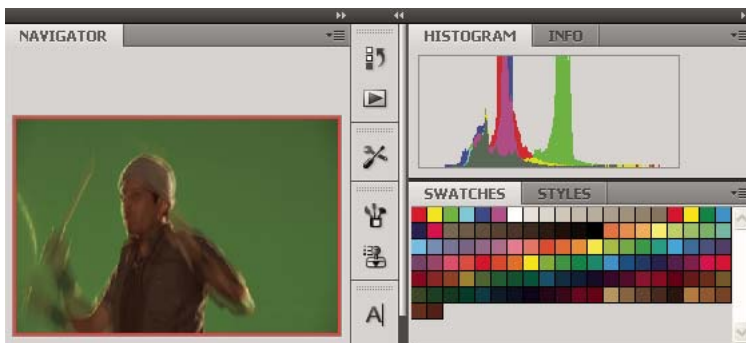

Navigator panel now in its own dock

💡 You can prevent panels from filling all the space in a dock. Drag the bottom edge of the dock up so it no longer meets the edge of the workspace.

Move panels

As you move panels, you see blue highlighted *drop zones*, areas where you can move the panel. For example, you can move a panel up or down in a dock by dragging it to the narrow blue drop zone above or below another panel. If you drag to an area that is not a drop zone, the panel floats freely in the workspace.

- To move a panel, drag it by its tab.
- To move a panel group or a stack of floating panels, drag the title bar.

💡 Press **Ctrl** (Windows) or **Command** (Mac OS) while moving a panel to prevent it from docking. Press **Esc** while moving the panel to cancel the operation.

Note: The dock is stationary and can't be moved. However, you can create panel groups or stacks and move them anywhere.

Add and remove panels

If you remove all panels from a dock, the dock disappears. You can create a dock by moving panels to the right edge of the workspace until a drop zone appears.

- To remove a panel, right-click (Windows) or Control-click (Mac) its tab and then select **Close**, or deselect it from the **Window** menu.
- To add a panel, select it from the **Window** menu and dock it wherever you want.

Manipulate panel groups

- To move a panel into a group, drag the panel's tab to the highlighted drop zone in the group.

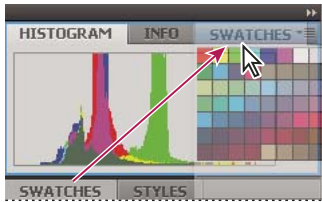

Adding a panel to a panel group

- To rearrange panels in a group, drag a panel's tab to a new location in the group.
- To remove a panel from a group so that it floats freely, drag the panel by its tab outside the group.
- To move a group, drag the title bar (the area above the tabs).

Stack floating panels

When you drag a panel out of its dock but not into a drop zone, the panel floats freely. The floating panel allows you to position it anywhere in the workspace. You can stack floating panels or panel groups so that they move as a unit when you drag the topmost title bar. (Panels that are part of a dock cannot be stacked or moved as a unit in this way.)

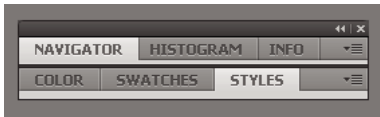

Free-floating stacked panels

- To stack floating panels, drag a panel by its tab to the drop zone at the bottom of another panel.
 - To change the stacking order, drag a panel up or down by its tab.
- Note:** Be sure to release the tab over the narrow drop zone between panels, rather than the broad drop zone in a title bar.
- To remove a panel or panel group from the stack, so that it floats by itself, drag it out by its tab or title bar.

Resize panels

- To minimize or maximize a panel, panel group, or stack of panels, double-click a tab. You can also single-click the tab area (the empty space next to the tabs).
- To resize a panel, drag any side of the panel. Some panels, such as the Color panel in Photoshop, cannot be resized by dragging.

Manipulate panels collapsed to icons

You can collapse panels to icons to reduce clutter on the workspace. In some cases, panels are collapsed to icons in the default workspace.

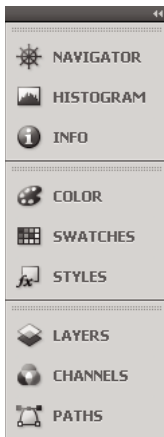

Panels collapsed to icons

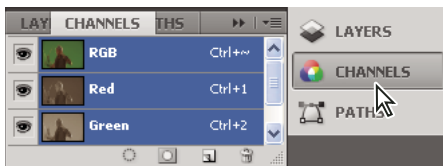

Panels expanded from icons

- To collapse or expand all panel icons in a dock, click the double arrow at the top of the dock.
- To expand a single panel icon, click it.
- To resize panel icons so that you see only the icons (and not the labels), adjust the width of the dock until the text disappears. To display the icon text again, make the dock wider.
- To collapse an expanded panel back to its icon, click its tab, its icon, or the double arrow in the panel's title bar.

 *In some products, if you select Auto-Collapse Icon Panels from the Interface or User Interface Options preferences, an expanded panel icon collapses automatically when you click away from it.*

- To add a floating panel or panel group to an icon dock, drag it in by its tab or title bar. (Panels are automatically collapsed to icons when added to an icon dock.)
- To move a panel icon (or panel icon group), drag the icon. You can drag panel icons up and down in the dock, into other docks (where they appear in the panel style of that dock), or outside the dock (where they appear as floating, expanded panels).

Restore the default workspace

- Select the default workspace from the workspace switcher in the Application bar.
- (Photoshop) Select Window > Workspace > Default Workspace.
- (InDesign, InCopy) Select Window > Workspace > Reset [*Workspace Name*].

Save and switch workspaces

By saving the current size and position of panels as a named workspace, you can restore that workspace even if you move or close a panel. The names of saved workspaces appear in the workspace switcher in the Application bar.

In Photoshop, the saved workspace can include a specific keyboard shortcut set and menu set.

Save a custom workspace

- 1 With the workspace in the configuration you want to save, do one of the following:
 - (Photoshop, Illustrator) Choose Window > Workspace > Save Workspace.
 - (InDesign, InCopy) Choose Window > Workspace > New Workspace.
 - (Dreamweaver) Choose Window > Workspace Layout > New Workspace.
 - (Flash) Choose New Workspace from the workspace switcher in the Application bar.
 - (Fireworks) Choose Save Current from the workspace switcher in the Application bar.
- 2 Type a name for the workspace.
- 3 (Photoshop, InDesign) Under Capture, select one or more options:
 - Panel Locations** Saves the current panel locations.
 - Keyboard shortcuts** Saves the current set of keyboard shortcuts (Photoshop only).
 - Menus** Saves the current set of menus.
- 4 Click OK or Save.

Display or switch workspaces

- ❖ Select a workspace from the workspace switcher in the Application bar.



In Photoshop, you can assign keyboard shortcuts to each workspace to navigate among them quickly.

Delete a custom workspace

- Select Manage Workspaces from the workspace switcher in the Application bar, select the workspace, and then click Delete. (The option is not available in Fireworks.)
- (Photoshop, InDesign, InCopy) Select Delete Workspace from the workspace switcher.
- (Illustrator) Choose Window > Workspace > Manage Workspaces, select the workspace, and then click the Delete icon.
- (InDesign) Choose Window > Workspace > Delete Workspace, select the workspace, and then click Delete.

(Photoshop) Start with the last or default panel locations

When you start Photoshop, panels can either appear in their original default locations, or appear as you last used them.

In Interface preferences:

- To display panels in their last locations on startup, select Remember Panel Locations.
- To display panels in their default locations on startup, deselect Remember Panel Locations.

Display or hide tool tips

- ❖ In Interface preferences, select or deselect Show Tool Tips.

Note: Tool tips may not be available in some dialog boxes.

Adobe Bridge

Adobe® Bridge is a cross-platform application included with Adobe® Creative Suite® 4 components. Adobe Bridge helps you locate, organize, and browse assets for print, web, video, and mobile content creation. You can start Bridge from most Creative Suite components, and use it to access both Adobe and non-Adobe assets.

From Adobe Bridge, you can:

- Manage image, video, and audio files: Preview, search, sort, and process files in Adobe Bridge without opening individual applications. You can also edit metadata for files, and use Adobe Bridge to place files into your documents, projects, or compositions.
- Manage your photos: Import and edit photos from your digital camera card, group related photos in stacks, and open or import camera raw files and edit their settings without starting Photoshop.
- Work with Adobe Version Cue®-managed assets.
- Perform automated tasks, such as batch commands.
- Synchronize color settings across color-managed Creative Suite components.

Panels and menus

Enter values in panels, dialog boxes, and the options bar

❖ Do any of the following:

- Type a value in the text box, and press Enter (Windows) or Return (Mac OS).
- Drag the slider.
- Move the pointer over the title of a slider or pop-up slider. When the pointer turns to a pointing finger, drag the scrubby slider to the left or right. This feature is available only for selected sliders and pop-up sliders.
- Drag the dial.
- Click the arrow buttons in the panel to increase or decrease the value.
- (Windows) Click the text box and then use the Up Arrow key and the Down Arrow key on the keyboard to increase or decrease the value.
- Select a value from the menu associated with the text box.

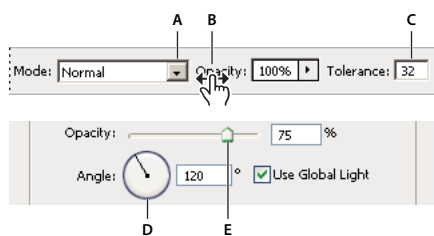

Ways to enter values

A. Menu arrow B. Scrubby slider C. Text box D. Dial E. Slider

See also

“[About scrubby sliders](#)” on page 15

About pop-up sliders

Some panels, dialog boxes, and options bars contain settings that use pop-up sliders (for example, the Opacity option in the Layers panel). If there is a triangle next to the text box, you can activate the pop-up slider by clicking the triangle. Position the pointer over the triangle next to the setting, hold down the mouse button, and drag the slider or angle radius to the desired value. Click outside the slider box or press Enter to close the slider box. To cancel changes, press the Esc key.

To increase or decrease values in 10% increments when the pop-up slider box is open, hold down Shift and press the Up Arrow or Down Arrow key.

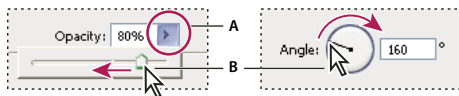

Using different kinds of pop-up sliders

A. Click to open pop-up slider box. B. Drag slider or angle radius.

 You can also “scrub” some pop-up sliders. For example, if you hold the pointer over the word “Fill” or “Opacity” in the Layers panel, the pointer changes to the Hand icon. Then you can move the pointer left or right to change the fill or opacity percentage.

About scrubby sliders

In some panels, dialog boxes, and options bars, you can drag scrubby sliders to change option values. Scrubby sliders are hidden until you position the pointer over the title of sliders and pop-up sliders. When the pointer changes to a pointing finger, you drag to the left or right. Holding down the Shift key while dragging accelerates the scrubbing by a factor of 10.



Hovering over the title of a slider or pop-up slider shows the scrubby slider

Working with pop-up panels

Pop-up panels provide easy access to available options for brushes, swatches, gradients, styles, patterns, contours, and shapes. You can customize pop-up panels by renaming and deleting items and by loading, saving, and replacing libraries. You can also change the display of a pop-up panel to view items by their names, as thumbnail icons, or with both names and icons.

Click a tool thumbnail in the options bar to show its pop-up panel. Click an item in the pop-up panel to select it.

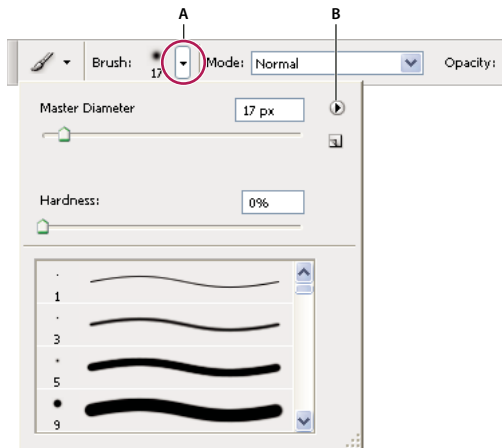

Viewing the Brush pop-up panel in the options bar
A. Click to show the pop-up panel. **B.** Click to view the pop-up panel menu.

Rename or delete an item in a pop-up panel

❖ Select an item, click the triangle in the upper right corner of the pop-up panel, and choose one of the following:

Rename Tool Preset Lets you enter a new name for the item.

Delete Tool Preset Deletes an item in the pop-up panel.

Note: You can also delete an item in a pop-up panel by holding down **Alt** (Windows) or **Option** (Mac OS) and clicking the item.

Customize the list of items in a pop-up panel

- 1 Click the triangle in the upper right corner of the pop-up panel to view the panel menu.
- 2 To return to the default library, choose the Reset Tool Presets command. You can either replace the current list or add the default library to the current list.
- 3 To load a different library, do one of the following:
 - Choose the Load Tool Presets command to add a library to the current list. Then select the library file you want to use, and click Load.
 - Choose the Replace Tool Presets command to replace the current list with a different library. Then select the library file you want to use, and click Load.
 - Choose a library file (displayed at the bottom of the panel menu). Then click OK to replace the current list, or click Append to add it to the current list.
- 4 To save the current list as a library for later use, choose the Save Tool Presets command. Then enter a name for the library file, and click Save.

💡 (Mac OS) Include the extension of the library file name so that you can easily share the libraries across operating systems. Select **Append File Extension Always** in the **File Handling Preferences** to append extensions to file names.

Change the display of items in a pop-up panel

- 1 Click the triangle in the upper right corner of the pop-up panel to view the panel menu.
- 2 Select a view option: Text Only, Small List, and Large List.

Display context menus

Context menus display commands relevant to the active tool, selection, or panel. They are distinct from the menus across the top of the workspace.

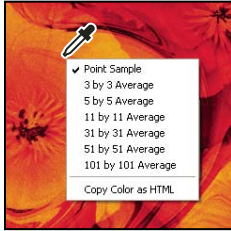

Viewing the context menu for the Eyedropper tool

- 1 Position the pointer over an image or panel item.
- 2 Right-click (Windows) or Control-click (Mac OS).

Define a set of menus

- 1 Do one of the following:
 - Choose Edit > Menus.
 - Choose Window > Workspace > Keyboard Shortcuts & Menus and click the Menus tab.
- 2 In the Keyboard Shortcuts and Menus dialog box, choose a set of menus from the Set drop-down menu. For information on creating a new set, see “[Customizing keyboard shortcuts](#)” on page 648.
- 3 Choose a type from the Menu For menu:

Application Menus Lets you show, hide, or add color to items in the application menus.

Panel Menus Lets you show, hide, or add color to items in panel menus.

- 4 Click the triangle next to a menu or panel name.
- 5 Do one of the following:
 - To hide a menu item, click the Visibility button
 - To show a menu item, click the empty Visibility button.
 - To add color to a menu item, click the color swatch (if no color is assigned, it will say None) and choose a color.
- 6 When you finish changing the menus, do one of the following:
 - To save all changes to the current set of menus, click the Save Set button
 - To create a new set based on the current set of menus, click the Save Set As button

Note: If you haven't saved the current set of changes, you can click Cancel to discard all changes and close the dialog box.

- 7 In the Save dialog box, enter a name for the set and click Save.

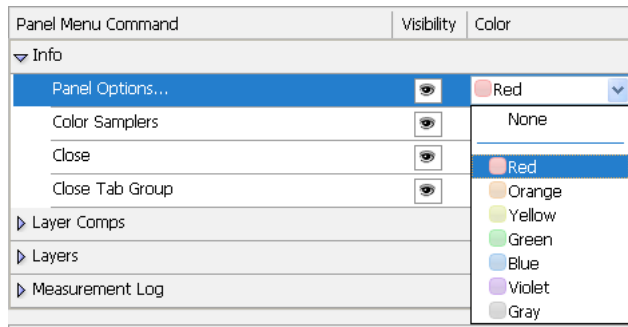

Choosing a color for a menu item using the Keyboard Shortcuts & Menus dialog box

Delete a set of menus

- Do one of the following:
 - Choose Edit > Menus.
 - Choose Window > Workspace > Keyboard Shortcuts & Menus and click the Menu tab.
- In the Keyboard Shortcuts & Menus dialog box, choose a set of menus from the Set menu.
- Click the Delete Set icon .

Temporarily show hidden menu items

It's possible to temporarily show items that you've hidden in a menu. After the menu closes, the items return to their hidden state.

- ❖ Do one of the following:
 - From a menu with hidden items, choose Show All Menu Items.
 - Ctrl-click (Windows) or Command-click (Mac OS) a menu with hidden items.

Turn menu colors on or off

- ❖ In Interface preferences, select or deselect Show Menu Colors.

Tools

About tools

When you start Photoshop, the Tools panel appears at the left of the screen. Some tools in the Tools panel have options that appear in the context-sensitive options bar. These include the tools that let you use type, select, paint, draw, sample, edit, move, annotate, and view images. Other tools allow you to change foreground/background colors, go to Adobe Online, and work in different modes.

You can expand some tools to show hidden tools beneath them. A small triangle at the lower right of the tool icon signals the presence of hidden tools.

You can view information about any tool by positioning the pointer over it. The name of the tool appears in a *tool tip* below the pointer.

Tools panel overview

- A Selection tools**
 - **Move (V)***
 - **Rectangular Marquee (M)**
 - Elliptical Marquee (M)
 - ▮ Single Column Marquee
 - ▮ Single Row Marquee
 - **Lasso (L)**
 - ▮ Polygonal Lasso (L)
 - ▮ Magnetic Lasso (L)
 - **Quick Selection (W)**
 - ▮ Magic Wand (W)
- B Crop and slice tools**
 - **Crop (C)**
 - ▮ Slice (C)
 - ▮ Slice Select (C)
- C Measuring tools**
 - **Eyedropper (I)**
 - ▮ Color Sampler (I)
 - ▮ Ruler (I)
 - ▮ Note (I)
 - ▮ Count (I)†
- D Retouching tools**
 - **Spot Healing Brush (J)**
 - ▮ Healing Brush (J)
 - ▮ Patch (J)
 - ▮ Red Eye (J)
 - **Clone Stamp (S)**
 - ▮ Pattern Stamp (S)
- E Eraser (E)**
 - ▮ Background Eraser (E)
 - ▮ Magic Eraser (E)
- Blur**
 - ▮ Sharpen
 - ▮ Smudge
- Dodge (O)**
 - ▮ Burn (O)
 - ▮ Sponge (O)
- E Painting tools**
 - **Brush (B)**
 - ▮ Pencil (B)
 - ▮ Color Replacement (B)
 - **History Brush (Y)**
 - ▮ Art History Brush (Y)
 - **Gradient (G)**
 - ▮ Paint Bucket (G)
- F Drawing and type tools**
 - **Pen (P)**
 - ▮ Freeform Pen (P)
 - ▮ Add Anchor Point
 - ▮ Delete Anchor Point
 - ▮ Convert Point
 - **Horizontal Type (T)**
 - ▮ Vertical Type (T)
 - ▮ Horizontal Type Mask (T)
 - ▮ Vertical Type Mask (T)
- G Path Selection (A)**
 - ▮ Direct Selection (A)
- Rectangle (U)**
 - ▮ Rounded Rectangle (U)
 - ▮ Ellipse (U)
 - ▮ Polygon (U)
 - ▮ Line (U)
 - ▮ Custom Shape (U)
- G Navigation & 3D tools**
 - **3D Rotate (K)†**
 - ▮ 3D Roll (K)†
 - ▮ 3D Pan (K)†
 - ▮ 3D Slide (K)†
 - ▮ 3D Scale (K)†
 - **3D Orbit (N)†**
 - ▮ 3D Roll View (N)†
 - ▮ 3D Pan View (N)†
 - ▮ 3D Walk View (N)†
 - ▮ 3D Zoom View (N)†
 - **Hand (H)**
 - ▮ Rotate View (R)
 - **Zoom (Z)**

■ Indicates default tool * Keyboard shortcuts appear in parenthesis † Extended only

See also

“[Workspace overview](#)” on page 6

Selection tools gallery



The marquee tools make rectangular, elliptical, single row, and single column selections.



The Move tool moves selections, layers, and guides.

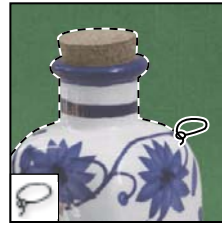

The lasso tools make freehand, polygonal (straight-edged), and magnetic (snap-to) selections.



The Quick Selection tool lets you quickly “paint” a selection using an adjustable round brush tip

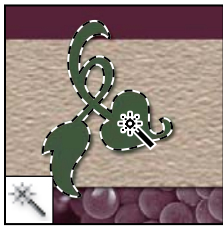

The Magic Wand tool selects similarly colored areas.

Crop and slice tools gallery



The Crop tool trims images.

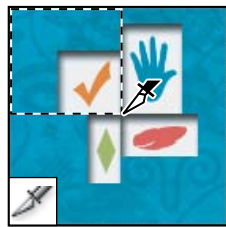

The Slice tool creates slices.



The Slice Select tool selects slices.

Retouching tools gallery

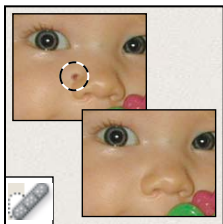

The Spot Healing Brush tool removes blemishes and objects



The Healing Brush tool paints with a sample or pattern to repair imperfections in a image.



The Patch tool repairs imperfections in a selected area of an image using a sample or pattern.

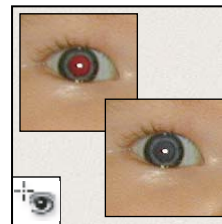

The Red Eye tool removes the red reflection caused by a flash.

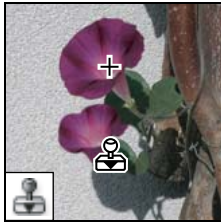

The Clone Stamp tool paints with a sample of an image.

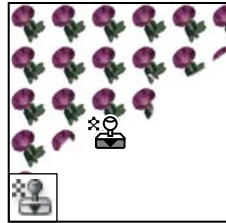

The Pattern Stamp tool paints with part of an image as a pattern.

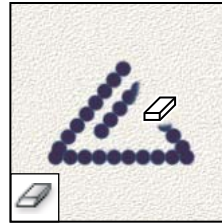

The Eraser tool erases pixels and restores parts of an image to a previously saved state.

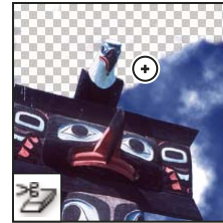

The Background Eraser tool erases areas to transparency by dragging.

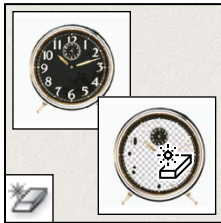

The Magic Eraser tool erases solid-colored areas to transparency with a single click.



The Blur tool blurs hard edges in an image.



The Sharpen tool sharpens soft edges in an image.

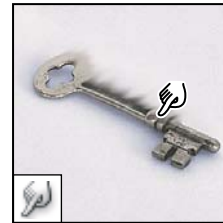

The Smudge tool smudges data in an image.



The Dodge tool lightens areas in an image.



The Burn tool darkens areas in an image.



The Sponge tool changes the color saturation of an area.

Painting tools gallery

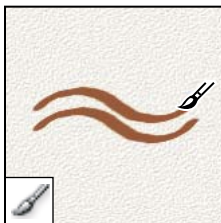

The Brush tool paints brush strokes.

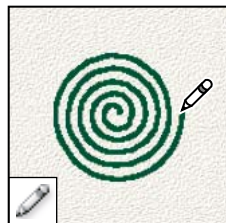

The Pencil tool paints hard-edged strokes.

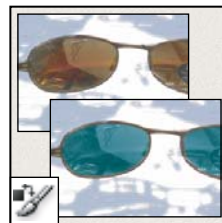

The Color Replacement tool replaces a selected color with a new color.



The History Brush tool paints a copy of the selected state or snapshot into the current image window.



The Art History brush tool paints with stylized strokes that simulate the look of different paint styles, using a selected state or snapshot.

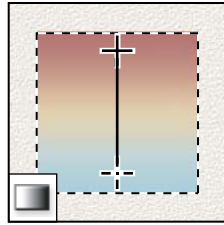

The gradient tools create straight-line, radial, angle, reflected, and diamond blends between colors.



The Paint Bucket tool fills similarly colored areas with the foreground color.

Drawing and type tools gallery

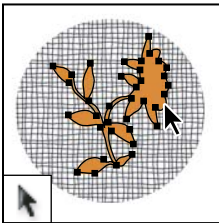

The path selection tools make shape or segment selections showing anchor points, direction lines, and direction points.



The type tools create type on an image.

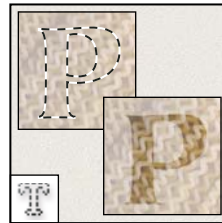

The type mask tools create a selection in the shape of type.

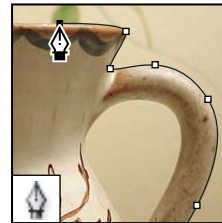

The pen tools let you draw smooth-edged paths.



The shape tools and Line tool draw shapes and lines in a normal layer or a shape layer.



The Custom Shape tool makes customized shapes selected from a custom shape list.

Notes, measuring and navigation tools gallery

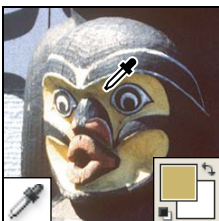

The Eyedropper tool samples colors in an image.

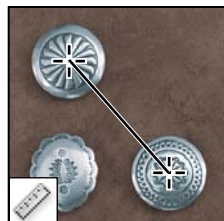

The Ruler tool measures distances, locations, and angles.

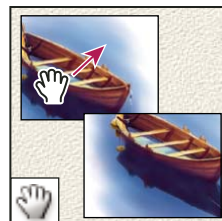

The Hand tool moves an image within its window.

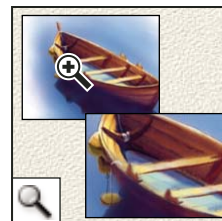

The Zoom tool magnifies and reduces the view of an image.

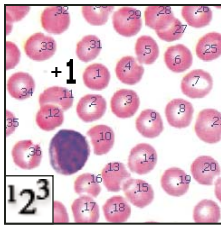

The Counting tool counts objects in an image. (Photoshop Extended only)

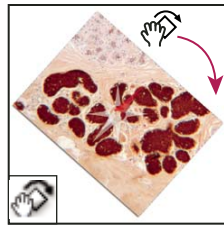

The Rotate View tool non-destructively rotates the canvas.

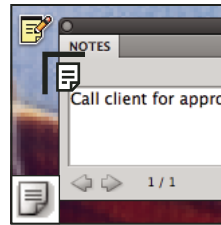

The Note tool makes notes that can be attached to an image.

3D tools (Photoshop Extended)



The 3D Rotate tool rotates the model around its x-axis (moves the object not the camera).

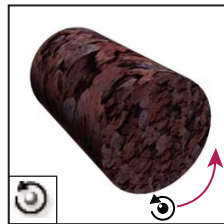

The 3D Roll tool rotates the model around its z-axis (moves the object not the camera).

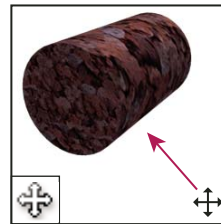

The 3D Pan tool pans the camera in the x or y direction (moves the object, not the camera).

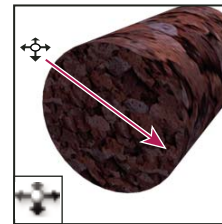

The 3D Slide tool drags side to side to move the model horizontally, or up and down to move the model closer or farther away.

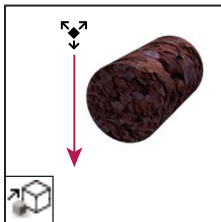

The 3D Scale tool scales the model larger or smaller.



The 3D Orbit tool orbits the camera in the x or y direction (moves the camera, not the object).



The 3D Roll View tool rotates the camera around the z-axis (moves the camera, not the object).

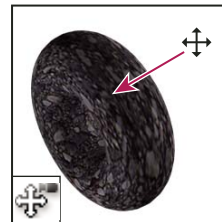

The 3D Pan View tool pans the camera in the x or y direction (moves the camera not the object).

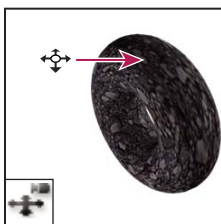

The 3D Walk View tool walks the camera.



The 3D Zoom tool changes the field of view closer or farther away.

Use a tool

- ❖ Do one of the following:
 - Click a tool in the Tools panel. If there is a small triangle at a tool's lower right corner, hold down the mouse button to view the hidden tools. Then click the tool you want to select.

- Press the tool's keyboard shortcut. The keyboard shortcut is displayed in its tool tip. For example, you can select the Move tool by pressing the V key.

 *Pressing and holding a keyboard shortcut key lets you temporarily switch to a tool. When you let go of the shortcut key, Photoshop returns to the tool you were using before the temporary switch.*

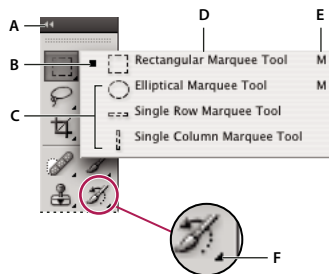

Using the selecting tools

A. Tools panel B. Active tool C. Hidden tools D. Tool name E. Tool shortcut F. Hidden tool triangle



Cycle through hidden tools

You can select a preference that allows you to cycle through a set of hidden tools by holding down the Shift key. When this preference is not selected, you can cycle through a set of hidden tools by pressing the tool's shortcut key (without holding down Shift).

- 1 Choose Edit > Preferences > General (Windows) or Photoshop > Preferences > General (Mac OS).
- 2 Select Use Shift Key For Tool Switch.

Change tool pointers

Each default pointer has a different *hotspot*, where an effect or action in the image begins. With most tools, you can switch to precise cursors, which appear as cross hairs centered around the hotspot.

In most cases, the pointer for a tool is the same as the icon for that tool; you see that pointer when you select the tool. The default pointer for the marquee tools is the cross-hair pointer ; for the text tool, the default pointer is the I-beam ; and for the painting tools the default pointer is the Brush Size icon.

- 1 Choose Edit > Preferences > Cursors (Windows) or choose Photoshop > Preferences > Cursors (Mac OS).
- 2 Choose tool pointer settings under Painting Cursors or Other Cursors:

Standard Displays pointers as tool icons.

Precise Displays pointers as cross hairs.

Normal Brush Tip The pointer outline corresponds to approximately 50% of the area that the tool will affect. This option shows the pixels that would be most visibly affected.

Full Size Brush Tip The pointer outline corresponds to nearly 100% of the area that the tool will affect, or nearly all the pixels that would be affected.

Show Crosshair In Brush Tip Displays cross hairs in the center of the brush shape.

- 3 Click OK.

The Painting Cursors options control the pointers for the following tools:

Eraser, Pencil, Paintbrush, Healing Brush, Rubber Stamp, Pattern Stamp, Quick Selection, Smudge, Blur, Sharpen, Dodge, Burn, and Sponge tools

The Other Cursors options control the pointers for the following tools:

Marquee, Lasso, Polygonal Lasso, Magic Wand, Crop, Slice, Patch, Eyedropper, Pen, Gradient, Line, Paint Bucket, Magnetic Lasso, Magnetic Pen, Freeform Pen, Measure, and Color Sampler tools

 To toggle between standard and precise cursors in some tool pointers, press Caps Lock.

Resize or change hardness of painting cursors by dragging

You can resize or change the hardness of a painting cursor by dragging in the image. As you drag, you preview both the size and hardness of the painting tool.

❖ Do one of the following:

- To resize a cursor, right-click + Alt (Windows) or Control + Option (Mac OS) and drag to the left or right.
- To change the hardness of a cursor, Shift + right-click + Alt (Windows) or Control + Option + Command (Mac OS) and drag to the left or right.

Using the options bar

The options bar appears below the menu bar at the top of the workspace. The options bar is context sensitive—it changes as you select different tools. Some settings in the options bar (such as painting modes and opacity) are common to several tools, and some are specific to one tool.

You can move the options bar in the workspace by using the gripper bar, and you can dock it at the top or bottom of the screen. Tool tips appear when you position the pointer over a tool. To show or hide the options bar, choose Window > Options.

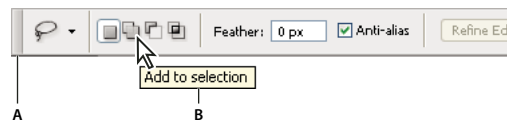

Lasso options bar
 A. Gripper bar B. Tool tip

To return tools to their default settings, right-click (Windows) or Control-click (Mac OS) the tool icon in the options bar, and then choose Reset Tool or Reset All Tools from the context menu.

For more information on setting options for a specific tool, search for the tool's name in Photoshop Help.

Create and use tool presets

Tool presets let you save and reuse tool settings. You can load, edit, and create libraries of tool presets using the Tool Preset picker in the options bar, the Tool Presets panel, and the Preset Manager.

To choose a tool preset, click the Tool Preset picker in the options bar, and select a preset from the pop-up panel. You can also choose Window > Tool Presets and select a preset in the Tools Presets panel.

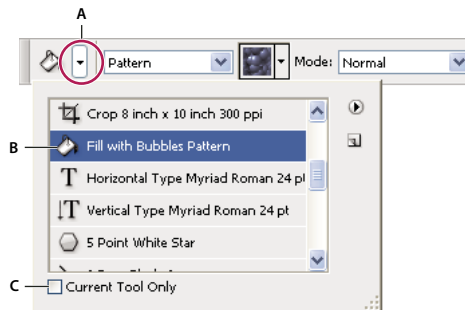

Viewing the Tool Preset picker

A. Click the Tool Preset picker in the options bar to show the Tool Preset pop-up panel. **B.** Select a preset to change the tool's options to the preset, which applies each time you select the tool until you choose Reset Tool from the panel menu. **C.** Deselect to show all tool presets; select to show presets for only the tool selected in the toolbox.

Create a tool preset

- 1 Choose a tool, and set the options you want to save as a tool preset in the options bar.
- 2 Do one of the following:
 - Click the Tool Preset button next to the tool at the left of the options bar.
 - Choose Window > Tool Presets to display the Tool Presets panel.
- 3 Do one of the following:
 - Click the Create New Tool Preset button .
 - Choose New Tool Preset from the panel menu.
- 4 Enter a name for the tool preset, and click OK.

Change the list of tool presets

❖ Click the triangle to open the Tool Presets pop-up panel menu and choose one of the following:

Show All Tool Presets Shows all loaded presets.

Sort By Tool Sorts the presets by tool.

Show Current Tool Presets Shows only the loaded presets for the active tool. You can also select the Current Tool Only option in the Tool Presets pop-up panel.

Text Only, Small List, or Large List Determines how presets are displayed in the pop-up panel.

Note: To create, load, and manage libraries of tool presets, see “Working with pop-up panels” on page 15 and “Work with the Preset Manager” on page 41.

Viewing images

Change the screen mode

You can use the screen mode options to view images on your entire screen. You can show or hide the menu bar, title bar, and scroll bars.

- ❖ Do one of the following:
 - To display the default mode (menu bar at the top and scroll bars on the side), choose View > Screen Mode > Standard Screen Mode. Or, click the Screen Mode button  ▼ in the Application bar, and select Standard Screen Mode from the pop-up menu.
 - To display a full-screen window with a menu bar and a 50% gray background, but no title bar or scroll bars, choose View > Screen Mode > Full Screen Mode With Menu Bar. Or, click the Screen Mode button in the Application bar, and select Full Screen Mode With Menu Bar from the pop-up menu.
 - To display a full-screen window with only a black background (no title bar, menu bar, or scroll bars), choose View > Screen Mode > Full Screen Mode. Or, click the Screen Mode button in the Application bar, and select Full Screen Mode from the pop-up menu.

View another area of an image

- ❖ Do one of the following:
 - Use the window scroll bars.
 - Select the Hand tool and drag to pan over the image. To use the Hand tool while another tool is selected, hold down the spacebar as you drag in the image.

 *If your computer has OpenGL, you can use the Hand tool to “flick pan” the image in the direction you want to view. After a quick mouse gesture, the image will move as if you were continuously dragging. Enable this feature by choosing Edit > Preferences > General (Windows) or Photoshop > Preferences > General (Mac OS) and then select Enable Flick Panning.*

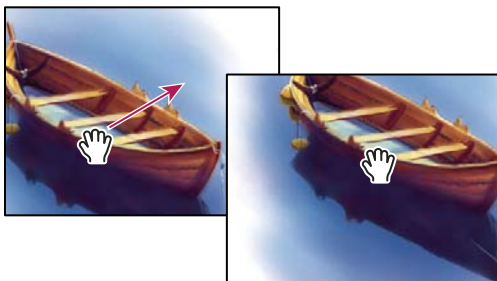

Dragging the Hand tool to view another area of an image

- Drag the colored box (proxy view area) in the Navigator panel.

Use the Rotate View tool

You use the Rotate View tool to rotate the canvas non-destructively; it does not transform the image. Rotating the canvas can be useful for any number of reasons, including facilitating easier painting or drawing. (OpenGL is required.)

 Use rotate gestures on Macbook Pro and Macbook Air computers with multi-touch trackpads to non-destructively rotate the canvas.

1 Do any of the following:

- Select the Rotate View tool  and click-drag in the image to rotate. A compass will indicate north in the image, regardless of the current canvas angle.
- Select the Rotate View tool. Enter a numeric value (to indicate degrees of shifting) in the Rotation Angle field.
- Select the Rotate View tool. Click (or click-drag to scrub) on the Set Angle of Rotation of the View control.

2 To restore the canvas to the original angle, click Reset View.

For a video on the Rotate View tool and other workspace tips, see www.adobe.com/go/lrvid4001_ps

Use the Navigator panel

You use the Navigator panel to quickly change the view of your artwork using a thumbnail display. The colored box in the Navigator (called the *proxy view area*) corresponds to the currently viewable area in the window.

❖ Do one or more of the following:

- To display the Navigator panel, select Window > Navigator.
- To change the magnification, type a value in the text box, click the Zoom Out or Zoom In button, or drag the zoom slider.
- To move the view of an image, drag the proxy view area in the image thumbnail. You can also click the image thumbnail to designate the viewable area.
- To change the color of the proxy view area, select Panel Options from the panel menu. Select a preset color from the Color pop-up menu, or click the color box to choose a custom color.

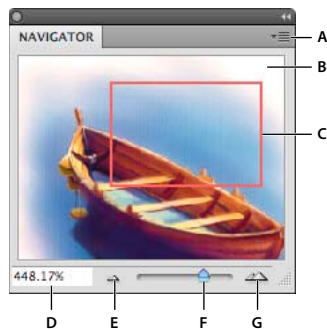



Navigator panel

A. Panel menu button B. Thumbnail display of artwork C. Proxy preview area D. Zoom text box E. Zoom Out button F. Zoom slider G. Zoom In button

Zoom in or out

Use the Zoom tool  or the View menu commands to zoom in or zoom out of an image. When you use the Zoom tool, each click magnifies or reduces the image to the next preset percentage and centers the display around the point you click. Over 500% magnification, the image's pixel grid becomes visible. When the image has reached its maximum magnification level of 3200% or minimum size of 1 pixel, the magnifying glass appears empty.

❖ Do any of the following:

- Select the Zoom tool , and click either the Zoom In  or Zoom Out button  in the options bar. Then, click the area you want to zoom in or out.

- Select the Zoom tool. The pointer becomes a magnifying glass with a plus sign in its center. Click the center of the area that you want to magnify. Hold down Alt (Windows) or Option (Mac OS) and click the center of the area that you want to reduce. The zoom will be smooth if your computer has OpenGL and Animated Zoom is selected in the General Preferences.
- Select the Zoom tool and then click-hold in the image for a continuous-motion smooth zoom in. Alt + click-hold (Windows) or Option + click-hold (Mac OS) to continuously zoom out. To use this feature, your computer must have OpenGL and Animated Zoom must be selected in the General Preferences.
- Select the Zoom tool and drag a dotted rectangle (*marquee*) around the area you want to magnify. To move the marquee around the artwork, hold down the spacebar and continue dragging until the marquee is in the desired location.
- Choose View > Zoom In or View > Zoom Out. The Zoom In or Zoom Out command becomes unavailable when the maximum image magnification or reduction is reached.
- Set the zoom level at the lower left corner of the document window or in the Navigator panel.

For a video on zooming and navigating in an image, see www.adobe.com/go/lrvid4010_ps

Set Zoom tool preferences

Some of the Zoom tool preferences require that your computer has OpenGL. If your computer has OpenGL, be sure to enable it in Photoshop. Choose Edit > Preferences > Performance (Windows) or Photoshop > Preferences > Performance (Mac OS), and then select Enable OpenGL Drawing under the GPU Settings.

- ❖ Edit > Preferences > General (Windows) or Photoshop > Preferences > General (Mac OS) and then do any of the following:
 - To enable continuous zooming in or out by holding down the Zoom tool, select Animated Zoom. Zooming from one magnification to another will also be smooth when clicking with the Zoom tool.
 - To enable zooming in or out using the scroll wheel on your mouse, select the Zoom With Scroll Wheel option.
 - To enable centering the zoom view on the click location, select the Zoom Clicked Point To Center option.

Zoom into or out of multiple images

- 1 Open one or more images, or open one image in multiple windows.
- 2 Choose Window > Arrange > Tile to display the images edge to edge.
- 3 Select the Zoom tool, and then do one of the following:
 - Select Zoom All Windows in the options bar, and then click one of the images. The other images zoom in or out at the same time.
 - Choose Window > Arrange > Match Zoom. Hold down the Shift key and click one of the images. The other images zoom in or out at the same magnification.

Magnify by dragging

- 1 Select the Zoom tool.
- 2 Drag over the part of the image that you want to magnify.

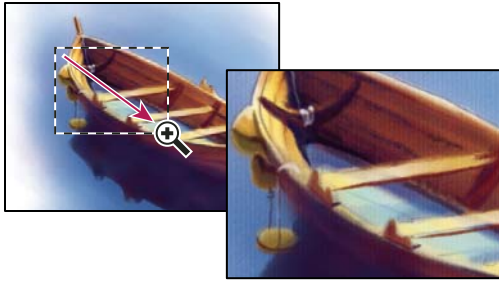

Dragging the Zoom tool to magnify the view of an image

The area inside the zoom marquee is displayed at the highest possible magnification. To move the marquee around the artwork in Photoshop, begin dragging a marquee and then hold down the spacebar while dragging.

Temporarily zoom an image

- 1 Select the Zoom tool.
- 2 Hold down the H key, and then click in the image and hold down the mouse button.

The Zoom tool changes to the Hand tool and the image magnification changes.

- 3 Release the mouse button.

The image returns to the previous magnification. Releasing the H key changes the Hand tool back to the Zoom tool.

Automatically resize the window when zooming

- ❖ With the Zoom tool active, select **Resize Windows To Fit** in the options bar. The window is resized when you magnify or reduce the view of the image.

When **Resize Windows To Fit** is deselected (the default), the window maintains a constant size regardless of the image magnification. This can be helpful when using smaller monitors or working with tiled views.

***Note:** To automatically resize the window when using keyboard shortcuts to reduce or magnify an image view, choose **Edit > Preferences > General (Windows)** or **Photoshop > Preferences > General (Mac OS)**, then select the **Zoom Resizes Windows** preference and click **OK**.*

Display an image at 100%

- ❖ Do one of the following:
 - Double-click the Zoom tool in the toolbox.
 - Choose **View > Actual Pixels**.
 - Enter 100% in the Status Bar and press **Enter (Windows)** or **Return (Mac OS)**.

***Note:** The 100% view of an image displays an image as it will appear in a browser (based on the monitor resolution and the image resolution).*

Fit an image to the screen

- ❖ Do one of the following:
 - Double-click the Hand tool in the toolbox.
 - Choose **View > Fit On Screen**.
 - Select a zoom tool or the Hand tool, and click the **Fit On Screen** button in the options bar.

These options scale both the zoom level and the window size to fit the available screen space.

View images in multiple windows

The document window is where your images appear. You can open multiple windows to display different images or different views of the same one. A list of open windows appears in the Window menu. To bring an open image to the front, choose the file name from the bottom of the Window menu. Available memory may limit the number of windows per image.

1 Choose Window > Arrange > New Window For *[Image File Name]*.

2 If you want to arrange the windows, choose Window > Arrange and then choose one of the following:

Cascade Displays undocked windows stacked and cascading from the upper-left to the lower right of the screen.

Tile Displays windows edge to edge. As you close images, the open windows are resized to fill the available space.

Float in Window Allows image to float freely.

Float All in Windows Floats all images.

Consolidate All to Tabs Shows one image in full screen and minimizes the other images to tabs.



You can use the Hand tool's Scroll All Windows option to scroll through all open images. Select it in the options bar and drag in one image to scroll through all visible images.

Match locations in images

1 Open one or more images, or open a single image in multiple windows.

2 Choose Window > Arrange > Tile.

3 Do either of the following:

- Choose Window > Arrange > Match Location.
- Select the Hand tool, select Scroll All Windows in the options bar, and then drag to view another area in one of the images. (To temporarily enable this option, hold down the Shift key while dragging with the Hand tool.)

Match zoom and locations in images

1 Open one or more images, or multiple copies of a single image.

2 Choose Window > Arrange > Tile.

3 Choose Window > Arrange > Match All.

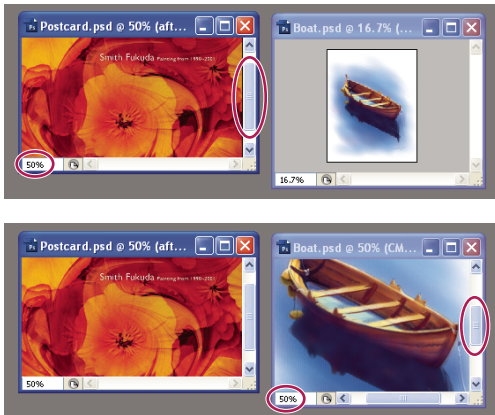

Without Match All command (top), and with Match All command (bottom) selected

- 4 Select the Zoom tool or the Hand tool.
- 5 Select one of the images, hold down the Shift key, and click in or drag an area of an image. The other images are magnified to the same percentage and snap to the area you clicked.

Work with the Info panel

The Info panel shows the color values beneath the pointer and, depending on the tool in use, gives other useful information. The Info panel also displays a hint on using the selected tool, gives document status information, and can display 8-bit, 16-bit, or 32-bit values.

The Info panel displays the following information:

- Depending on the option you specify, the Info panel displays 8-bit, 16-bit, or 32-bit values.
- When displaying CMYK values, the Info panel displays an exclamation point next to the CMYK values if the color beneath the pointer or color sampler is out of the printable CMYK color gamut.
- When a marquee tool is being used, the Info panel displays the x and y coordinates of the pointer position and the width (W) and height (H) of the marquee as you drag.
- When the Crop tool or Zoom tool is being used, the Info panel displays the width (W) and height (H) of the marquee as you drag. The panel also shows the angle of rotation of the crop marquee.
- When the Line tool, the Pen tool, or Gradient tool is being used, or when a selection is being moved, the Info panel displays the x and y coordinates of your starting position, the change in X (DX), the change in Y (DY), the angle (A), and the length (D) as you drag.
- When a two-dimensional transformation command is being used, the Info panel displays the percentage change in width (W) and height (H), the angle of rotation (A), and the angle of horizontal skew (H) or vertical skew (V).
- When any color adjustment dialog box (for example, Curves) is being used, the Info panel displays before-and-after color values for the pixels beneath the pointer and beneath color samplers.
- If the Show Tool Hints option is enabled, you see hints for using the tool selected in the toolbox.
- Depending on the options selected, the Info panel displays status information, such as document size, document profile, document dimensions, scratch sizes, efficiency, timing, and current tool.

Use the Info panel

The Info panel displays file information about an image and also provides feedback about the color values as you move a tool pointer over an image. Make sure the Info panel is visible in your workspace if you want to view information while dragging in the image.

1 (Optional) Do one of the following if you need to display the Info panel:

- Click the Info panel tab if it's docked with other panels.
- Choose Window > Info. File information about the image is displayed at the bottom of the Info panel. You can change the information displayed by clicking the triangle in the upper right corner of the panel and choosing Panel Options from the panel menu.

2 Set the options for the information you want displayed in the Info Panel by doing any of the following:

- Choose Panel Options from the Info panel menu and specify options in the Info Panel Options dialog box.
- Click an eyedropper icon and choose display options from the pop-up menu. You can also use the pop-up menu to specify whether the Info panel displays 8-bit, 16-bit, or 32-bit values.
- Click the cursor coordinates icon , and choose a unit of measurement.

3 Select a tool.

4 Move the pointer in the image, or drag in the image to use the tool. The following information may appear, depending on which tool you're using:

 Displays the numeric values for the color beneath the pointer.

 Displays the *x* and *y* coordinates of the pointer.

 Displays the width (W) and height (H) of a marquee or shape as you drag, or the width and height of an active selection.

Change the Info panel options

1 Click the triangle in the upper right corner to open the Info panel menu and choose Panel Options.

2 In the Info Panel Options dialog box, for First Color Readout, choose one of the following display options:

Actual Color Displays values in the current color mode of the image.

Proof Color Displays values for the output color space of the image.

A color mode Displays the color values in that color mode.

Total Ink Displays the total percentage of all CMYK ink at the pointer's current location, based on the values set in the CMYK Setup dialog box.

Opacity Displays the opacity of the current layer. This option does not apply to the background.

 You can also set the readout options by clicking the eyedropper icon in the Info panel. In addition to the First Color Readout options, you can also display 8-bit, 16-bit, or 32-bit values.

3 For Second Color Readout, choose a display option from the list in step 2. For the second readout, you can also click the eyedropper icon in the Info panel and choose readout options from the pop-up menu.

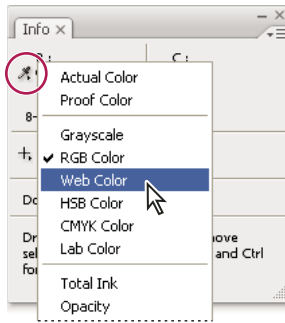

Clicking an eyedropper icon and choosing a readout mode from the pop-up menu

4 For Ruler Units, choose a unit of measurement.

5 Under Status information, select from the following to display file information in the Info panel:

Document Sizes Displays information on the amount of data in the image. The number on the left represents the printing size of the image—approximately the size of the saved, flattened file in Adobe Photoshop format. The number on the right indicates the file's approximate size including layers and channels.

Document Profile Displays the name of the color profile used by the image.

Document Dimensions Displays the dimensions of the image.

Scratch Sizes Displays information on the amount of RAM and the scratch disk used to process the image. The number on the left represents the amount of memory that is currently being used by the program to display all open images. The number on the right represents the total amount of RAM available for processing images.

Efficiency Displays the percentage of time spent performing an operation instead of reading or writing to the scratch disk. If the value is below 100%, Photoshop is using the scratch disk and is therefore operating more slowly.

Timing Displays the amount of time it took to complete the last operation.

Current Tool Displays the name of the active tool.

Version Cue Displays Version Cue workgroup status. This option is valid when Version Cue is active.

Measurement Scale Displays the scale of the document.

6 (Optional) Select Show Tool Hints to display a hint for using a selected tool at the bottom of the Info panel.

7 Click OK.



To change measurement units, click the crosshair icon in the Info panel and choose from the menu.

Display file information in the document window

The status bar is located at the bottom of every document window and displays useful information—such as the current magnification and file size of the active image, and brief instructions for using the active tool. The status bar also displays Version Cue information if you have Version Cue enabled.

Note: You can also view copyright and authorship information that has been added to the file. This information includes standard file information and Digimarc watermarks. Photoshop automatically scans opened images for watermarks using the Digimarc Detect Watermark plug-in. If a watermark is detected, Photoshop displays a copyright symbol in the image window's title bar and updates the Copyright fields of the File Info dialog box.

1 Click the triangle in the bottom border of the document window.

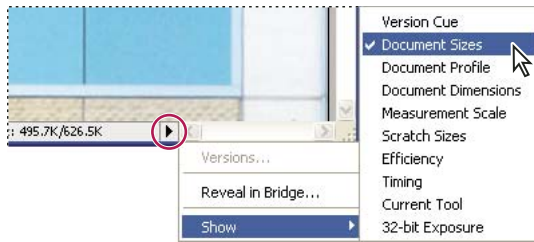

File information view options when Version Cue is enabled

2 Choose a view option from the pop-up menu:

Note: If you have Version Cue enabled, choose from the Show submenu.

Version Cue Displays the Version Cue workgroup status of your document, such as open, unmanaged, unsaved, and so forth. This option is available only if you have Version Cue enabled.

Document Sizes Information on the amount of data in the image. The number on the left represents the printing size of the image—approximately the size of the saved, flattened file in Adobe Photoshop format. The number on the right indicates the file's approximate size, including layers and channels.

Document Profile The name of the color profile used by the image.

Document Dimensions The dimensions of the image.

Measurement Scale The scale of the document.

Scratch Sizes Information on the amount of RAM and the scratch disk used to process the image. The number on the left represents the amount of memory currently being used by the program to display all open images. The number on the right represents the total amount of RAM available for processing images.

Efficiency The percentage of time actually spent performing an operation instead of reading or writing to the scratch disk. If the value is below 100%, Photoshop is using the scratch disk and is therefore operating more slowly.

Timing The time it took to complete the last operation.

Current Tool The name of the active tool.

32-bit Exposure Option for adjusting the preview image for viewing 32-bits-per-channel high dynamic range (HDR) images on your computer monitor. The slider is available only when the document window displays an HDR image.

See also

“Adjust dynamic range view for HDR images” on page 75

Duplicate an image

You can duplicate an entire image (including all layers, layer masks, and channels) into available memory without saving to disk.

- 1 Open the image you want to duplicate.
- 2 Choose Image > Duplicate.
- 3 Enter a name for the duplicated image.
- 4 If you want to duplicate the image and merge the layers, select Duplicate Merged Layers Only. To preserve the layers, make sure this option is deselected.
- 5 Click OK.

Rulers, the grid, and guides

About rulers

Rulers help you position images or elements precisely. When visible, rulers appear along the top and left side of the active window. Markers in the ruler display the pointer's position when you move it. Changing the ruler origin (the (0, 0) mark on the top and left rulers) lets you measure from a specific point on the image. The ruler origin also determines the grid's point of origin.

To show or hide rulers, choose View > Rulers.

Change a ruler's zero origin

- 1 (Optional) Choose View > Snap To, then choose any combination of options from the submenu. This snaps the ruler origin to guides, slices, or document bounds. You can also snap to the grid.
- 2 Position the pointer over the intersection of the rulers in the upper-left corner of the window, and drag diagonally down onto the image. A set of cross hairs appears, marking the new origin on the rulers.

 You can hold down Shift as you drag to make the ruler origin snap to the ruler ticks.

To reset a ruler's origin to its default value, double-click the upper-left corner of the ruler.

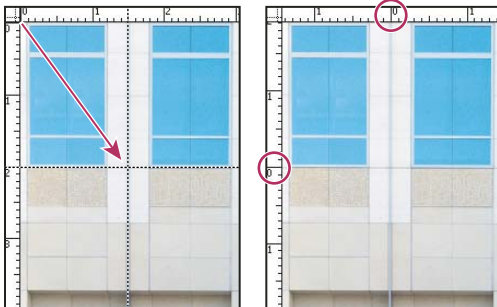

Dragging to create new ruler origin

See also

[“Use snapping”](#) on page 40

Change the unit of measurement

- 1 Do one of the following:
 - Double-click a ruler.
 - (Windows) Choose Edit > Preferences > Units & Rulers, or right-click the ruler and then choose a new unit from the context menu.
 - (Mac OS) Choose Photoshop > Preferences > Units & Rulers, or Control-click the ruler and then choose a new unit from the context menu.
- 2 For Rulers, choose a unit of measurement.

Note: Changing the units on the Info panel automatically changes the units on the rulers.

3 For Point/Pica Size, choose from the following options:

PostScript (72 points per inch) Sets a unit size compatible for printing to a PostScript device.

Traditional Uses 72.27 points per inch, as traditionally used in printing.

4 Click OK.

Specify columns for an image

Columns help you position images or elements precisely. The New, Image Size, and Canvas Size commands let you specify image width in terms of columns. Using columns is convenient when you plan to import an image into a page-layout program, such as Adobe InDesign®, and you want the image to fit exactly within a certain number of columns.

- 1 Choose Edit > Preferences > Units & Rulers (Windows) or Photoshop > Preferences > Units & Rulers (Mac OS).
- 2 Enter values for Width and Gutter.

Position with the Ruler tool

The Ruler tool  helps you position images or elements precisely. The Ruler tool calculates the distance between any two points in the workspace. When you measure from one point to another, a nonprinting line is drawn, and the options bar and Info panel show the following information:

- The starting location (X and Y)
- The horizontal (W) and vertical (H) distances traveled from the *x* and *y* axes
- The angle measured relative to the axis (A)
- The total length traveled (D1)
- The two lengths traveled (D1 and D2), when you use a protractor

All measurements except the angle are calculated in the unit of measure currently set in the Units & Rulers preference dialog box.

If your document has an existing measuring line, selecting the Ruler tool causes it to be displayed.

Measure between two points

- 1 Select the Ruler tool .
- 2 Drag from the starting point to the ending point. Hold down the Shift key to constrain the tool to 45° increments.
- 3 To create a protractor from an existing measuring line, Alt-drag (Windows) or Option-drag (Mac OS) at an angle from one end of the measuring line, or double-click the line and drag. Hold down the Shift key to constrain the tool to multiples of 45°.

Edit a measuring line

- 1 Select the Ruler tool .
- 2 Do one of the following:
 - To resize the line, drag one end of an existing measuring line.
 - To move the line, place the pointer on the line away from either endpoint, and drag the line.
 - To remove the line, place the pointer on the line away from either endpoint, and drag the line out of the image, or click Clear in the tool options bar.

Note: You can drag out a measure line on an image feature that should be horizontal or vertical, and then choose Image > Image Rotation > Arbitrary. The correct angle of rotation required to straighten the image is automatically entered into the Rotate Canvas dialog box.

Position with guides and the grid

Guides and the grid help you position images or elements precisely. Guides appear as nonprinting lines that float over the image. You can move and remove guides. You can also lock them so that you don't move them by accident.

The grid is useful for laying out elements symmetrically. The grid appears by default as nonprinting lines but can also be displayed as dots.

Guides and grids behave in similar ways:

- Selections, selection borders, and tools snap to a guide or the grid when dragged within 8 screen (not image) pixels. Guides also snap to the grid when moved. You can turn this feature on and off.
- Guide spacing, along with guide and grid visibility and snapping, is specific to an image.
- Grid spacing, along with guide and grid color and style, is the same for all images.

You can use Smart Guides to help align shapes, slices, and selections. They appear automatically when you draw a shape, or create a selection or slide. You can hide Smart Guides if you need to.

See also

[“Slice a web page”](#) on page 498

Show or hide a grid, guides, or smart guides

❖ Do one of the following:

- Choose View > Show > Grid.
- Choose View > Show > Guides.
- View > Show > Smart Guides.
- Choose View > Extras. This command also shows or hides layer edges, selection edges, target paths, and slices.

Place a guide

1 If the rulers are not visible, choose View > Rulers.

Note: For the most accurate readings, view the image at 100% magnification or use the Info panel.

2 Do one of the following to create a guide:

- Choose View > New Guide. In the dialog box, select Horizontal or Vertical orientation, enter a position, and click OK.
- Drag from the horizontal ruler to create a horizontal guide.

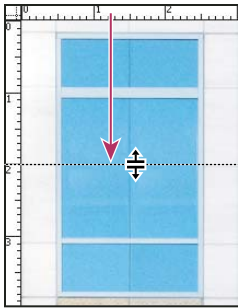

Dragging to create a horizontal guide

- Hold down Alt (Windows) or Option (Mac OS), and drag from the vertical ruler to create a horizontal guide.
 - Drag from the vertical ruler to create a vertical guide.
 - Hold down Alt (Windows) or Option (Mac OS), and drag from the horizontal ruler to create a vertical guide.
 - Hold down Shift and drag from the horizontal or vertical ruler to create a guide that snaps to the ruler ticks. The pointer changes to a double-headed arrow when you drag a guide.
- 3 (Optional) If you want to lock all guides, choose View > Lock Guides.

Move a guide

- 1 Select the Move tool , or hold down Ctrl (Windows) or Command (Mac OS) to activate the Move tool.
- 2 Position the pointer over the guide (the pointer turns into a double-headed arrow).
- 3 Move the guide in any of the following ways:
 - Drag the guide to move it.
 - Change the guide from horizontal to vertical, or vice versa, by holding down Alt (Windows) or Option (Mac OS) as you click or drag the guide.
 - Align the guide with the ruler ticks by holding down Shift as you drag the guide. The guide snaps to the grid if the grid is visible and View > Snap To > Grid is selected.

Remove guides from the image

- ❖ Do one of the following:
 - To remove a single guide, drag the guide outside the image window.
 - To remove all guides, choose View > Clear Guides.

Set guide and grid preferences

- 1 Do one of the following:
 - (Windows) Choose Edit > Preferences > Guides, Grid, & Slices.
 - (Mac OS) Choose Photoshop > Preferences > Guides, Grid, & Slices.
- 2 For Color, choose a color for the guides, the grid, or both. If you choose Custom, click the color box, choose a color, and click OK.
- 3 For Style, choose a display option for guides or the grid, or both.
- 4 For Gridline Every, enter a value for the grid spacing. For Subdivisions, enter a value by which to subdivide the grid.

If desired, change the units for this option. The Percent option creates a grid that divides the image into even sections. For example, choosing 25 for the Percent option creates an evenly divided 4-by-4 grid.

5 Click OK.

Use snapping

Snapping helps with precise placement of selection edges, cropping marquee, slices, shapes, and paths. However, sometimes snapping prevents you from correctly placing elements. You can enable or disable snapping using the Snap command. You can also specify different elements to which you want to snap when snapping is enabled.

Enable snapping

❖ Choose View > Snap. A check mark indicates that snapping is enabled.

Specify what to snap to

❖ Choose View > Snap To, and choose one or more options from the submenu:

Guides Snaps to guides.

Grid Snaps to the grid. You cannot select this option when the grid is hidden.

Layer Snaps to the content in the layer.

Slices Snaps to slice boundaries. You cannot select this option when slices are hidden.

Document Bounds Snaps to the edges of the document.

All Selects all Snap To options.

None Deselects all Snap To options.

A check mark indicates that the option is selected and snapping is enabled.

 *If you want to enable snapping for only one option, make sure the Snap command is disabled, and then choose View > Snap To and choose an option. This automatically enables snapping for the selected option, and deselects all other Snap To options.*

Show or hide Extras

Guides, grid, target paths, selection edges, slices, text bounds, text baselines, and text selections are nonprinting *Extras* that help you select, move, or edit images and objects. You can turn on or off an Extra or any combination of Extras without affecting the image. You can also show or hide Extras by choosing the Extras command in the View menu.

Hiding Extras only suppresses the display of Extras. It does not turn off these options.

❖ Do one of the following:

- To show or hide Extras, choose View > Extras. A check mark appears next to all shown Extras in the Show submenu.
- To turn on and show an Extra from a group of hidden Extras, choose View > Show and choose an Extra from the submenu.
- To turn on and show all available Extras, choose View > Show > All.
- To turn off and hide all Extras, choose View > Show > None.

Note: Showing Extras causes color samplers to be shown as well, even though color samplers are not an option in the Show submenu.

Presets, Plug-ins, and Preferences

Work with the Preset Manager

About the Preset Manager

The Preset Manager lets you manage the libraries of preset brushes, swatches, gradients, styles, patterns, contours, custom shapes, and preset tools that come with Photoshop. For example, you can use the Preset Manager to change the current set of preset items or create new libraries. After you load a library in the Preset Manager, you can access the library's items in locations such as the options bar, panels, dialog boxes, and so on.

In general, when you change a preset, Photoshop prompts you to save the changes as a new preset so that both the original and changed preset remain available.

Each type of library has its own file extension and default folder. Preset files are installed on your computer inside the Presets folder in the Adobe Photoshop CS4 application folder.

To open the Preset Manager, choose Edit > Preset Manager. Choose an option from the Preset Type menu to switch to a specific preset type.

You can adjust the configuration of presets by clicking the panel menu button and choosing a display mode from the top section of the menu:

Text Only Displays the name of each preset item.

Small Thumbnail or Large Thumbnail Displays a thumbnail of each preset item.

Small List or Large List Displays the name and thumbnail of each preset item.

Stroke Thumbnail Displays a sample brush stroke and brush thumbnail of each brush preset. (This option is available for brush presets only.)

To rearrange the list of items, drag an item up or down in the list.

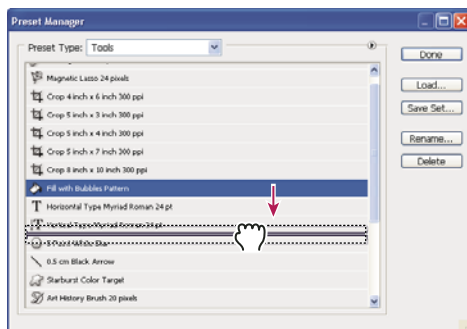

Rearranging tool presets in the Preset Manager

Note: To delete a preset in the Preset Manager, select the preset and click Delete. You can always use the Reset command to restore the default items in a library.

Load a library of preset items

❖ Do one of the following:

- Click the triangle to the right of the Preset Type pop-up menu and then choose a library file from the bottom of the panel menu. Click OK to replace the current list, or click Append to add the current list.

- To add a library to the current list, click Load, select the library file you want to add, and click Load.
- To replace the current list with a different library, choose Replace [*Preset Type*] from the panel menu. Select the library file you want to use, and click Load.

Note: Each type of library has its own file extension and default folder.

Manage preset items

You can rename or delete preset items, as well as create or restore libraries of presets.

Rename preset items

- 1 Select a preset item. Shift-click to select multiple items.
- 2 Do one of the following:
 - Click Rename, and then enter a new name for the brush, swatch, and so on.
 - If the Preset Manager currently displays presets as thumbnails, double-click a preset, enter a new name, and click OK.
 - If the Preset Manager currently displays presets as a list or text only, double-click a preset, enter a new name inline, and press Enter (Windows) or Return (Mac OS).

Delete preset items

- ❖ Do one of the following:
 - Select a preset item, and click Delete.
 - Alt-click (Windows) or Option-click (Mac OS) the items you want to delete.

Create a new library of presets

- 1 Do one of the following:
 - To save all the presets in the list as a library, make sure that all items are selected.
 - To save a subset of the current list as a library, hold down Shift, and select the items you want to save.
- 2 Click Save Set, choose a location for the library, enter a file name, and click Save.

You can save the library anywhere. However, if you place the library file in the appropriate Presets folder in the default preset location, the library name will appear at the bottom of the panel menu after you restart Photoshop.

Restore the default library of preset items

- ❖ Choose Reset from the panel menu. You can either replace the current list or append the default library to the current list.

Default preset locations

- 1 The default location for saving/loading/replacing presets depends on your operating system.
 - Mac: <User>/Library/Application Support/Adobe/Adobe Photoshop CS4/Presets.
 - Windows XP: [Drive]:\Document and Settings\<user>\Application Data\Adobe\Adobe Photoshop CS4\Presets.
 - Windows Vista: [Drive]:\Users\<user>\AppData\Roaming\Adobe\Adobe Photoshop CS4\Presets.
- 2 Presets that ship with Adobe Photoshop CS4 are stored in the Photoshop program folder.

Displaying Hidden Files in Windows

The default locations for saving/loading/replacing presets are hidden by default in Windows.

- 1 To display hidden files in Windows XP:
 - a Go to Start > Control Panel > Folder Options.
 - b In the View tab, under Hidden files and folders, select Show hidden files and folders.
 - c Click OK.
- 2 To display hidden files in Windows Vista:
 - a Go to Start > Control Panel > Appearance and Personalization > Folder Options.
 - b In the View tab, under Hidden files and folders, select Show hidden files and folders.
 - c Click OK.

Preferences

About preferences

Numerous program settings are stored in the Adobe Photoshop CS4 Prefs file, including general display options, file-saving options, performance options, cursor options, transparency options, type options, and options for plug-ins and scratch disks. Most of these options are set in the Preferences dialog box. Preference settings are saved each time you quit the application.

Unexpected behavior may indicate damaged preferences. If you suspect damage to preferences, restore preferences to their default settings.

Open a preferences dialog box

- 1 Do one of the following:
 - (Windows) Choose Edit > Preferences and choose the desired preference set from the submenu.
 - (Mac OS) Choose Photoshop > Preferences, and then choose the desired preference set from the submenu.
- 2 To switch to a different preference set, do one of the following:
 - Choose the preference set from the menu at the left of the dialog box.
 - Click Next to display the next preference set in the list; click Prev to display the previous set.

For information on a specific preference option, see the index.

Restore all preferences to default settings

- ❖ Do one of the following:
 - Press and hold Alt+Control+Shift (Windows) or Option+Command+Shift (Mac OS) as you start Photoshop. You are prompted to delete the current settings.
 - (Mac OS only) Open the Preferences folder in the Library folder, and drag the Adobe Photoshop CS Settings folder to the Trash.

New Preferences files are created the next time you start Photoshop.

Disable and enable warning messages

Sometimes you will see messages containing warnings or prompts. You can suppress the display of these messages by selecting the Don't Show Again option in the message. You can also globally redisplay all messages that have been suppressed.

- 1 Do one of the following:
 - (Windows) Choose Edit > Preferences > General.
 - (Mac OS) Choose Photoshop > Preferences > General.
- 2 Click Reset All Warning Dialogs, and click OK.

Plug-ins

About plug-in modules

Plug-in modules are software programs developed by Adobe Systems and by other software developers in conjunction with Adobe Systems to add features to Photoshop. A number of importing, exporting, and special-effects plug-ins come with your program. They are automatically installed in folders inside the Photoshop Plug-ins folder.

You can select an additional Plug-ins folder for compatible plug-ins stored with another application. You can also create a shortcut (Windows) or an alias (Mac OS) for a plug-in stored in another folder on your system. You can then add the shortcut or alias to the plug-ins folder and use that plug-in with Photoshop.

Once installed, plug-in modules appear as options in the Import or Export menu; as file formats in the Open, and Save As dialog boxes; or as filters in the Filter submenus. Photoshop can accommodate a large number of plug-ins. However, if the list of installed plug-in modules becomes too long, Photoshop may not be able to display all the plug-ins in their appropriate menus. If so, newly installed plug-ins appear in the Filter > Other submenu.

Install a plug-in module

In Mac OS, you cannot run Photoshop in the Classic environment. Plug-ins originally intended to work on Mac OS 9 won't appear.

- ❖ Do one of the following:
 - To install an Adobe Systems plug-in module, use the plug-in installer, if provided. In Windows, you can also install or copy the module into the appropriate Plug-ins folder in the Photoshop program folder. In Mac OS, drag a copy of the module to the appropriate Plug-Ins folder in the Photoshop program folder. Make sure that the files are uncompressed.
 - To install a third-party plug-in module, follow the installation instructions that came with the plug-in module. If you cannot run a third-party plug-in, it may require a legacy Photoshop serial number.

Select an additional plug-ins folder

- 1 Choose Edit > Preferences > Plug-ins (Windows) or choose Photoshop > Preferences > Plug-ins (Mac OS).
- 2 Select Additional Plug-ins Folder.
- 3 Click Choose, and select a folder or directory from the list. Make sure that you do not select a location inside the Plug-ins folder. To display the contents of a folder, double-click the directory (Windows) or click Open (Mac OS).
- 4 When you have highlighted the additional plug-ins folder, click OK (Windows) or Choose (Mac OS).
- 5 Restart Photoshop for the plug-ins to take effect.

Suppress the loading of plug-ins

- ❖ Add a tilde ~ character at the beginning of the plug-in name, folder, or directory. That file (or all files in the folder) will be ignored by the application.

View information about installed plug-ins

- ❖ Do one of the following:
 - (Windows) Choose Help > About Plug-in and choose a plug-in from the submenu.
 - (Mac OS) Choose Photoshop > About Plug-in, and then choose a plug-in from the submenu.

Undo and history panel

Use the Undo or Redo commands

The Undo and Redo commands let you undo or redo operations. You can also use the History panel to undo or redo operations.

- ❖ Choose Edit > Undo or Edit > Redo.

If an operation can't be undone, the command is dimmed and changes to Can't Undo.

See also



[“Work with the History panel”](#) on page 46

Revert to the last saved version

- ❖ Choose File > Revert.

Note: Revert is added as a history state in the History panel and can be undone.

Restore part of an image to its previously saved version

- ❖ Do one of the following:
 - Use the History Brush tool  to paint with the selected state or snapshot on the History panel.
 - Use the Eraser tool  with the Erase To History option selected.
 - Select the area you want to restore, and choose Edit > Fill. For Use, choose History, and click OK.

Note: To restore the image with a snapshot of the initial state of the document, choose History Options from the Panel menu and make sure that the Automatically Create First Snapshot option is selected.

See also

[“Erase with the Eraser tool”](#) on page 331

Cancel an operation

- ❖ Hold down Esc until the operation in progress has stopped. In Mac OS, you can also press Command+period.

Receive notification when an operation is completed

A progress bar indicates that an operation is being performed. You can interrupt the operation or have the program notify you when it has finished the operation.

- 1 Do one of the following:
 - (Windows) choose Edit > Preferences > General.
 - (Mac OS) choose Photoshop > Preferences > General.
- 2 Select Beep When Done.
- 3 Click OK.

Work with the History panel

You can use the History panel to jump to any recent state of the image created during the current working session. Each time you apply a change to an image, the new state of that image is added to the panel.

For example, if you select, paint, and rotate part of an image, each of those states is listed separately in the panel. When you select one of the states, the image reverts to how it looked when that change was first applied. You can then work from that state.

You can also use the History panel to delete image states and, in Photoshop, to create a document from a state or snapshot.

To display the History panel, choose Window > History, or click the History panel tab.

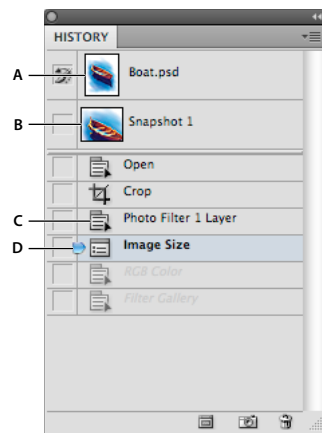

Photoshop History panel

A. Sets the source for the history brush B. Thumbnail of a snapshot C. History state D. History state slider

Keep the following in mind when using the History panel:

- Program-wide changes, such as changes to panels, color settings, actions, and preferences, are not reflected in the History panel, because they are not changes to a particular image.
- By default, the History panel lists the previous 20 states. You can change the number of remembered states by setting a preference. Older states are automatically deleted to free more memory for Photoshop. To keep a particular state throughout your work session, make a snapshot of the state.
- Once you close and reopen the document, all states and snapshots from the last working session are cleared from the panel.
- By default, a snapshot of the initial state of the document is displayed at the top of the panel.

- States are added to the bottom of the list. That is, the oldest state is at the top of the list, the most recent one at the bottom.
- Each state is listed with the name of the tool or command used to change the image.
- By default, when you select a state, the states below it are dimmed. This way you can easily see which changes will be discarded if you continue working from the selected state.
- By default, selecting a state and then changing the image eliminates all states that come after it.
- If you select a state and then change the image, eliminating the states that came after, you can use the Undo command to undo the last change and restore the eliminated states.
- By default, deleting a state deletes that state and those that came after it. If you choose the Allow Non-Linear History option, deleting a state deletes only that state.



Revert to a previous image state

- ❖ Do any of the following:
 - Click the name of the state.
 - Choose Step Forward or Step Backward from the History panel menu or the Edit menu to move to the next or previous state.

Delete one or more image states

- ❖ Do one of the following:
 - Click the name of the state, and choose Delete from the History panel menu to delete that change and those that came after it.
 - Drag the state to the Delete icon  to delete that change and those that came after it.
 - Choose Clear History from the panel menu to delete the list of states from the History panel, without changing the image. This option doesn't reduce the amount of memory used by Photoshop.
 - Hold down Alt (Windows) or Option (Mac OS), and choose Clear History from the panel menu to purge the list of states without changing the image. If you get a message that Photoshop is low on memory, purging states is useful, because the command deletes the states from the Undo buffer and frees up memory. You can't undo the Clear History command.
 - Choose Edit > Purge > Histories to purge the list of states for all open documents. You can't undo this action.

Create or replace a document with an image state

- ❖ Do one of the following:
 - Drag a state or snapshot onto the Create a New Document From Current State button  in the History panel. The history list for the newly created document contains only the Duplicate State entry.
 - Select a state or snapshot, and click the Create a New Document From Current State button . The history list for the newly created document contains only the Duplicate State entry.
 - Select a state or snapshot, and choose New Document from the History panel menu. The history list for the newly created document contains only the Duplicate State entry.
 - Drag a state onto an existing document.

 *To save one or more snapshots or image states for use in a later editing session, create a new file for each state you save, and save each in a separate file. When you reopen your original file, plan to open the other saved files also. You can drag each file's initial snapshot to the original image to access the snapshots again from the original image's History panel.*

Set history options

You can specify the maximum number of items to include in the History panel and set other options to customize the panel.

- 1 Choose History Options from the History panel menu.
- 2 Select an option:

Automatically Create First Snapshot Automatically creates a snapshot of the initial state of the image when the document is opened.

Automatically Create New Snapshot When Saving Generates a snapshot every time you save.

Allow Non-Linear History Makes changes to a selected state without deleting the states that come after. Normally, when you select a state and change the image, all states that come after the selected one are deleted. In this way, the History panel can display a list of the editing steps in the order that they were made. By recording states in a nonlinear way, you can select a state, make a change to the image, and delete just that state. The change is appended at the end of the list.

Show New Snapshot Dialog By Default Forces Photoshop to prompt you for snapshot names even when you use the buttons on the panel.

Make Layer Visibility Changes Undoable By default, turning layer visibility on or off is not recorded as a history step and therefore can't be undone. Select this option to include layer visibility changes in history steps.

Set Edit History Log options

You may need to keep careful track of what's been done to a file in Photoshop, either for your own records, client records, or legal purposes. The Edit History Log helps you keep a textual history of changes made to an image. You can view the Edit History Log metadata using Adobe Bridge or the File Info dialog box.

You can choose to export the text to an external log file, or you can store the information in the metadata of edited files. Storing many editing operations as file metadata increases file size; such files may take longer than usual to open and save.

 *If you need to prove that the log file hasn't been tampered with, keep the edit log in the file's metadata, and then use Adobe Acrobat to digitally sign the log file.*

By default, history log data about each session is saved as metadata embedded in the image file. You can specify where the history log data is saved and the level of detail contained in the history log.

- 1 Choose Edit > Preferences > General (Windows) or Photoshop > Preferences > General (Mac OS).
- 2 Click the History Log preference to toggle from on to off or vice versa.
- 3 For the Save Log Items To option, choose one of the following:

Metadata Saves the history log as metadata embedded in each file.

Text File Exports the history log to a text file. You are prompted to name the text file and choose a location in which to store it.

Both Stores metadata in the file and creates a text file.

Note: *If you want to save the text file in a different location or save another text file, click the Choose button, specify where to save the text file, name the file if necessary, and click Save.*

- 4 From the Edit Log Items menu, choose one of the following options:

Sessions Only Keeps a record of each time you start or quit Photoshop and each time you open and close files (each image's filename is included). Does not include any information about edits made to the file.

Concise Includes the text that appears in the History panel in addition to the Sessions information.

Detailed Includes the text that appears in the Actions panel in addition to the Concise information. If you need a complete history of all changes made to files, choose Detailed.

Make a snapshot of an image

The Snapshot command lets you make a temporary copy (or *snapshot*) of any state of the image. The new snapshot is added to the list of snapshots at the top of the History panel. Selecting a snapshot lets you work from that version of the image.

Snapshots are similar to the states listed in the History panel, but they offer additional advantages:

- You can name a snapshot to make it easy to identify.
- Snapshots can be stored for an entire work session.
- You can compare effects easily. For example, you can take a snapshot before and after applying a filter. Then select the first snapshot, and try the same filter with different settings. Switch between the snapshots to find the settings you like best.
- With snapshots, you can recover your work easily. When you experiment with a complex technique or apply an action, take a snapshot first. If you're not satisfied with the results, you can select the snapshot to undo all the steps.

***Note:** Snapshots are not saved with the image—closing an image deletes its snapshots. Also, unless you select the Allow Non-Linear History option, selecting a snapshot and changing the image deletes all of the states currently listed in the History panel.*

See also

[“About blending modes”](#) on page 346

[“Create a brush and set painting options”](#) on page 336

[“Paint with the Art History Brush”](#) on page 330

Create a snapshot

1 Select a state and do one of the following:

- To automatically create a snapshot, click the Create New Snapshot button  on the History panel, or if Automatically Create New Snapshot When Saving is selected in the history options, choose New Snapshot from the History panel menu.
- To set options when creating a snapshot, choose New Snapshot from the History panel menu, or Alt-click (Windows) or Option-click (Mac OS) the Create New Snapshot button.

2 Enter the name of the Snapshot in the Name text box.

3 Choose the snapshot contents from the From menu:

Full Document Makes a snapshot of all layers in the image at that state

Merged Layers Makes a snapshot that merges all layers in the image at that state

Current Layer Makes a snapshot of only the currently selected layer at that state

Work with snapshots

- ❖ Do one of the following:
 - To select a snapshot, click the name of the snapshot or drag the slider at the left of the snapshot up or down to a different snapshot.
 - To rename a snapshot, double-click the snapshot and enter a name.
 - To delete a snapshot, select the snapshot and either choose Delete from the panel menu, click the Delete icon , or drag the snapshot to the Delete icon.

Paint with a state or snapshot of an image

The History Brush tool  lets you paint a copy of one image state or snapshot into the current image window. This tool makes a copy, or sample, of the image and then paints with it.

For example, you might make a snapshot of a change you made with a painting tool or filter (with the Full Document option selected when you create the snapshot). After undoing the change to the image, you could use the History Brush tool to apply the change selectively to areas of the image. Unless you select a merged snapshot, the History Brush tool paints from a layer in the selected state to the same layer in another state.

The History Brush tool copies from one state or snapshot to another, but only at the same location. In Photoshop, you can also paint with the Art History Brush tool to create special effects.

- 1 Select the History Brush tool .
- 2 Do one of the following in the options bar:
 - Specify the opacity and blending mode.
 - Choose a brush and set brush options.
- 3 In the History panel, click the left column of the state or snapshot to be used as the source for the History Brush tool.
- 4 Drag to paint with the History Brush tool.

See also

[“Paint with the Art History Brush”](#) on page 330

Memory and performance

Allocate RAM to Photoshop

Photoshop displays the RAM available to Photoshop and the ideal range of RAM for Photoshop (a percentage of the total available RAM) in Performance preferences.

- ❖ In Performance preferences, enter the amount of RAM you want to allocate to Photoshop in the Let Photoshop Use text box. Alternatively, drag the slider.

Assigning scratch disks

When your system does not have enough RAM to perform an operation, Photoshop uses a proprietary virtual memory technology, also called scratch disks. A *scratch disk* is any drive or drive partition with free memory. By default, Photoshop uses the hard drive on which the operating system is installed as the primary scratch disk.

Photoshop detects and displays all available internal disks in the Preferences panel. Using the Preferences panel, you can enable other scratch disks to be used when the primary disk is full. Your primary scratch disk should be your fastest hard disk; make sure it has plenty of defragmented space available.

The following guidelines can help you assign scratch disks:

- For best performance, scratch disks should be on a different drive than any large files you are editing.
- Scratch disks should be on a different drive than the one used for virtual memory.
- RAID disks/disk arrays are good choices for dedicated scratch disk volumes.
- Drives with scratch disks should be defragmented regularly.

Change the scratch disk assignment

- 1 Do any of the following in the Scratch Disks area of Performance preferences:
 - To change the scratch disk order, click the arrow buttons.
 - To enable or disable a scratch disk, select or deselect the Active checkbox.
- 2 Click OK.
- 3 For the changes to take effect, you will need to restart Photoshop.

Specify history and cache settings

- ❖ In Performance preferences, do any of the following:
 - To specify how many states the History panel displays by default, click the triangle on the History States menu and drag the slider.
 - To specify the cache level Photoshop uses, drag the Cache Level slider. You must restart Photoshop to have the cache settings take effect.

Free memory

The Purge command lets you free memory used by the Undo command, the History panel, or the clipboard.

- ❖ Choose Edit > Purge, and choose the item type or buffer you want to clear. If it is already empty, the item type or buffer is dimmed.

Note: *The Purge command permanently clears from memory the operation stored by the command or buffer; Purge cannot be undone. For example, choosing Edit > Purge > Histories deletes all history states from the History panel. Use the Purge command when the amount of information in memory is so large that Photoshop performance is noticeably affected.*

Managing connections

Working with ConnectNow

Adobe® ConnectNow provides you with a secure, personal online meeting room where you can meet and collaborate with others via the web in real time. With ConnectNow, you can share and annotate your computer screen, send chat messages, and communicate using integrated audio. You can also broadcast live video, share files, capture meeting notes, and control an attendee's computer.

You can access ConnectNow directly from the application interface.

- 1 Choose File > Share My Screen.
- 2 In the Share My Screen dialog box, enter your Adobe ID and password, and click Sign In. If you don't have an Adobe ID and password, click the Create a Free Adobe ID link at the top of the dialog box.
- 3 To share your screen, click the Share My Computer Screen button at the center of the ConnectNow application window.

For complete instructions on using ConnectNow, see http://help.adobe.com/en_US/Acrobat.com/ConnectNow/index.html.

Manage connections to web services

In Adobe® Creative Suite® 4, the Connections panel lets you manage connections to web services and the locally installed extensions that interact with them. The Connections panel itself is an extension. Additional extensions installed with Creative Suite applications include the following:

Adobe ConnectNow Collaborate with dispersed working teams over the web, sharing voice, data, and multimedia.

Kuler™ panel Quickly create, share, and explore color themes online.

Search for Help In the upper-right corner of applications, enter search terms to access in-depth Help from Adobe, plus additional content from the design and production communities.

Visit Adobe.com to learn about additional services and extensions.

Log into Adobe web services

Regardless of which application you use to access the Connections panel, logging in automatically connects you to services such as ConnectNow meetings.

- 1 In Adobe InDesign, Photoshop, Illustrator, Flash, Fireworks, or Dreamweaver, choose Window > Extensions > Connections.
- 2 Enter your Adobe ID and password. (If you lack an ID or can't remember it, click the appropriate link.)
- 3 (Optional) To remain logged in when you restart the computer, select Remember Me On This Computer.
- 4 Click Log In.

Disable automatic extension updates

By default, the Connections panel automatically updates installed extensions. However, you can disable automatic updates and instead check for them manually.

- 1 From the Connections panel menu , select Update Preferences.

- 2 Deselect Check For Updates Automatically.
- 3 Restart any open Adobe Creative Suite applications.

Manually check for updated extensions

- ❖ From the Connections panel menu , select Check For Updates.

Disable web services

If your work environment disallows online connections, disable web services.

- 1 From the Connections panel menu , select Offline Options.
- 2 Select Keep Me Offline.
- 3 Restart any open Adobe Creative Suite applications.

 *To disable the Connections panel and web services only in Photoshop, deselect Allow Extensions To Connect in the Plug-Ins section of the Preferences dialog box.*

Chapter 3: Opening and importing images

Adobe® Photoshop® CS4 can open and import many types of graphic files. To work effectively, you should understand basic imaging concepts, and how to acquire, import, and resize images.

Image essentials

About bitmap images

Bitmap images—technically called *raster images*—use a rectangular grid of picture elements (pixels) to represent images. Each pixel is assigned a specific location and color value. When working with bitmap images, you edit pixels rather than objects or shapes. Bitmap images are the most common electronic medium for continuous-tone images, such as photographs or digital paintings, because they can more efficiently represent subtle gradations of shades and color.

Bitmap images are resolution-dependent—that is, they contain a fixed number of pixels. As a result, they can lose detail and appear jagged if they are scaled to high magnifications on-screen or if they are printed at a lower resolution than they were created for.



Example of a bitmap image at different levels of magnification

Bitmap images sometimes require large amounts of storage space, and often need to be compressed to keep file sizes down when used in certain Creative Suite components. For instance, you compress an image file in its original application before you import it into a layout.

Note: In Adobe Illustrator, you can create bitmap effects in your artwork using effects and graphic styles.

See also

[“About vector graphics”](#) on page 54

About vector graphics

Vector graphics (sometimes called *vector shapes* or *vector objects*) are made up of lines and curves defined by mathematical objects called *vectors*, which describe an image according to its geometric characteristics.

You can freely move or modify vector graphics without losing detail or clarity, because they are resolution-independent—they maintain crisp edges when resized, printed to a PostScript printer, saved in a PDF file, or imported into a vector-based graphics application. As a result, vector graphics are the best choice for artwork, such as logos, that will be used at various sizes and in various output media.

The vector objects you create using the drawing and shape tools in Adobe Creative Suite are examples of vector graphics. You can use the Copy and Paste commands to duplicate vector graphics between Creative Suite components.

See also

[“About bitmap images”](#) on page 54

Combining vector graphics and bitmap images

When combining vector graphics and bitmap images in a document, it’s important to remember that how your artwork looks on-screen isn’t always how it will look in its final medium (whether commercially printed, printed on a desktop printer, or viewed on the web). The following factors influence the quality of your final artwork:

Transparency Many effects add partially transparent pixels to your artwork. When your artwork contains transparency, Photoshop performs a process called *flattening* before printing or exporting. In most cases, the default flattening process produces excellent results. However, if your artwork contains complex, overlapping areas and you require high-resolution output, you will probably want to preview the effects of flattening.

Image Resolution The number of pixels per inch (ppi) in a bitmap image. Using too low a resolution for a printed image results in *pixelation*—output with large, coarse-looking pixels. Using too high a resolution (pixels smaller than what the output device can produce) increases the file size without increasing the quality of the printed output, and slows the printing of the artwork.

Printer resolution and screen frequency The number of ink dots produced per inch (dpi) and the number of lines per inch (lpi) in a halftone screen. The relationship between image resolution, printer resolution, and screen frequency determines the quality of detail in the printed image.

Color channels

Every Photoshop image has one or more *channels*, each storing information about color elements in the image. The number of default color channels in an image depends on its color mode. By default, images in Bitmap, Grayscale, Duotone, and Indexed Color mode have one channel; RGB and Lab images have three; and CMYK images have four. You can add channels to all image types except Bitmap mode images. For more information, see [“Color modes”](#) on page 106.

Channels in color images are actually grayscale images that represent each of the color components of an image. For example, an RGB image has separate channels for red, green, and blue color values.

In addition to color channels, *alphachannels*, can be added to an image for storing and editing selections as masks, and spot color channels can be added to add spot color plates for printing. For more information, see [“Channels”](#) on page 265.

See also

[“About masks and alpha channels”](#) on page 269

[“About spot colors”](#) on page 491

Bit depth

Bit depth specifies how much color information is available for each pixel in an image. The more bits of information per pixel, the more available colors and more accurate color representation. For example, an image with a bit depth of 1 has pixels with two possible values: black and white. An image with a bit depth of 8 has 2^8 , or 256, possible values. Grayscale mode images with a bit depth of 8 have 256 possible gray values.

RGB images are made of three color channels. An 8-bit per pixel RGB image has 256 possible values for each channel which means it has over 16 million possible color values. RGB images with 8-bits per channel (bpc) are sometimes called 24-bit images (8 bits x 3 channels = 24 bits of data for each pixel).

In addition to 8-bpc images, Photoshop can also work with images that contain 16-bpc or 32-bpc. Images with 32-bpc are also known as high dynamic range (HDR) images.

Photoshop support for 16-bit images

Photoshop provides the following support for working with 16-bpc images:

- Working in Grayscale, RGB Color, CMYK Color, Lab Color, and Multichannel, modes.
- All tools in the toolbox, except the Art History Brush tool, can be used with 16-bpc images.
- All color and tonal adjustment commands, except Variations, are available
- You can work with layers, including adjustment layers, in 16-bpc images.
- Some filters, including Liquify, can be used with 16-bpc images.

To take advantage of certain Photoshop CS4 features, such as some filters, you can convert a 16-bpc image to an 8-bpc image. It's best if you do a Save As and convert a copy of the image file so the original file retains the full 16-bpc image data.

See also

[“About high dynamic range images”](#) on page 71

Convert between bit depths

❖ Do any of the following:

- To convert between 8 bpc and 16 bpc, Choose Image > Mode > 16 Bits/Channel or 8 Bits/Channel.
- To convert from 8 bpc or 16 bits to 32 bpc, choose Image > Mode > 32 Bits/Channel.

See also

[“Convert from 32 bits to 8 or 16 bpc”](#) on page 75

Image size and resolution

About pixel dimensions and resolution

The pixel dimensions (image size or height and width) of a bitmap image is a measure of the number of pixels along an image's width and height. Resolution is the fineness of detail in a bitmap image and is measured in pixels per inch (ppi). The more pixels per inch, the greater the resolution. Generally, an image with a higher resolution produces a better printed image quality.

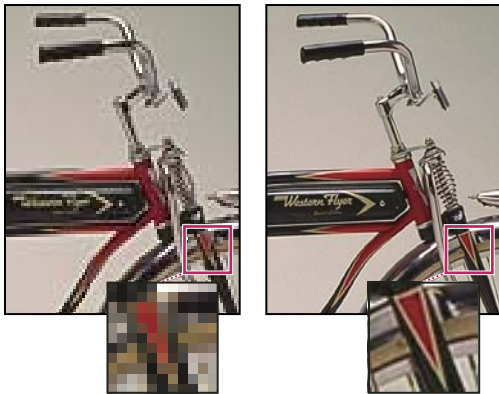

Same image at 72-ppi and 300-ppi; inset zoom 200%

The combination of pixel dimension and resolution determine the amount of image data. Unless an image is *resampled*, the amount of image data remains the same as you change either the pixel dimension or resolution. If you change the resolution of a file, its width and height change accordingly to maintain the same amount of image data. And, vice versa. For more information, see “Resampling” on page 59.

In Photoshop, you can see the relationship between image size and resolution in the Image Size dialog box (choose Image > Image Size). Deselect Resample Image, because you don’t want to change the amount of image data in your photo. Then change the width or the height or the resolution. As you change one value, the other two values change accordingly.

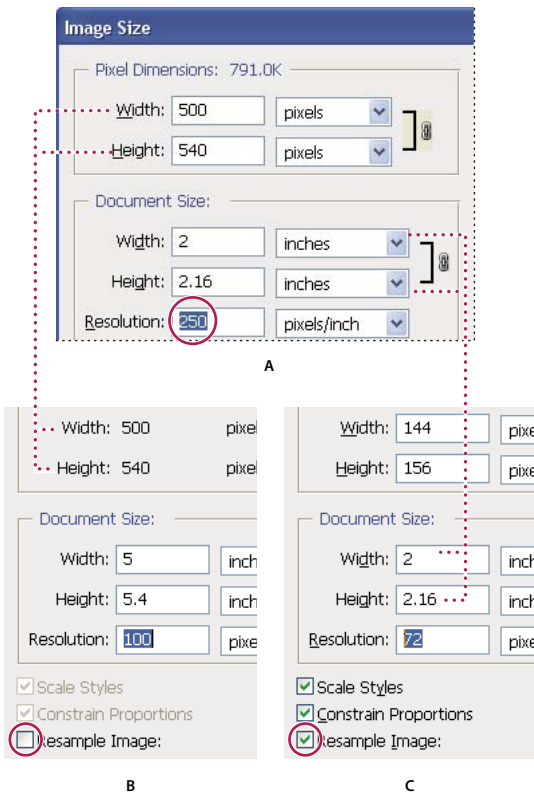

Pixel dimensions equal document (output) size times resolution.
A. Original dimensions and resolution **B.** Decreasing the resolution without changing pixel dimensions (no resampling) **C.** Decreasing the resolution at same document size decreases pixel dimensions (resampling).

Display the current image size quickly

If you want to quickly display a document's current image size, use the information box at the bottom of the document window.

- ❖ Position the pointer over the file information box, and hold down the mouse button.

File size

The file size of an image is the digital size of the image file, measured in kilobytes (K), megabytes (MB), or gigabytes (GB). File size is proportional to the pixel dimensions of the image. Images with more pixels may produce more detail at a given printed size, but they require more disk space to store and may be slower to edit and print. Image resolution thus becomes a compromise between image quality (capturing all the data you need) and file size.

Another factor that affects file size is file format. Because of the varying compression methods used by GIF, JPEG, and PNG file formats, file sizes can vary considerably for the same pixel dimensions. Similarly, color bit-depth and the number of layers and channels in an image affect file size.

Photoshop supports a maximum pixel dimension of 300,000 by 300,000 pixels per image. This restriction places limits on the print size and resolution available to an image.

About monitor resolution

Your monitor's resolution is described in pixel dimensions. For example, if your monitor resolution and your photo's pixel dimensions are the same size, the photo will fill the screen when viewed at 100%. How large an image appears on-screen depends on a combination of factors—the pixel dimensions of the image, the monitor size, and the monitor resolution setting. In Photoshop, you can change the image magnification on-screen, so you can easily work with images of any pixel dimensions.

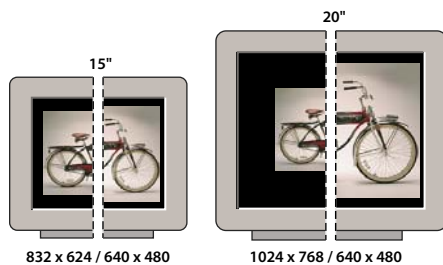

A 620- by 400-pixel image displayed on monitors of various sizes and resolutions.

When preparing images for viewing on-screen, you should consider the lowest monitor resolution that your photo is likely to be viewed on.

About printer resolution

Printer resolution is measured in ink dots per inch, also known as dpi. Generally, the more dots per inch, the finer the printed output you'll get. Most inkjet printers have a resolution of approximately 720 to 2880 dpi. (Technically, inkjet printers produce a microscopic spray of ink, not actual dots like imagesetters or laser printers.)

Printer resolution is different from, but related to image resolution. To print a high quality photo on an inkjet printer, an image resolution of at least 220 ppi should provide good results.

Screen frequency is the number of printer dots or halftone cells per inch used to print grayscale images or color separations. Also known as *screen ruling* or *line screen*, screen frequency is measured in lines per inch (lpi)—or lines of cells per inch in a halftone screen. The higher the resolution of the output device, the finer (higher) a screen ruling you can use.

The relationship between image resolution and screen frequency determines the quality of detail in the printed image. To produce a halftone image of the highest quality, you generally use an image resolution that is from 1.5 to at most 2 times the screen frequency. But with some images and output devices, a lower resolution can produce good results. To determine your printer’s screen frequency, check your printer documentation or consult your service provider.

Note: Some imagesetters and 600-dpi laser printers use screening technologies other than halftoning. If you are printing an image on a nonhalftone printer, consult your service provider or your printer documentation for the recommended image resolutions.



Screen frequency examples

A. 65 lpi: Coarse screen typically used to print newsletters and grocery coupons **B.** 85 lpi: Average screen typically used to print newspapers
C. 133 lpi: High-quality screen typically used to print four-color magazines **D.** 177 lpi: Very fine screen typically used for annual reports and images in art books

See also

[“About desktop printing”](#) on page 473

[“Preparing images for press”](#) on page 481

Resampling

Resampling is changing the amount of image data as you change either the pixel dimensions or the resolution of an image. When you *downsample* (decrease the number of pixels), information is deleted from the image. When you *resample up* (increase the number of pixels, or *upsample*), new pixels are added. You specify an *interpolation* method to determine how pixels are added or deleted.

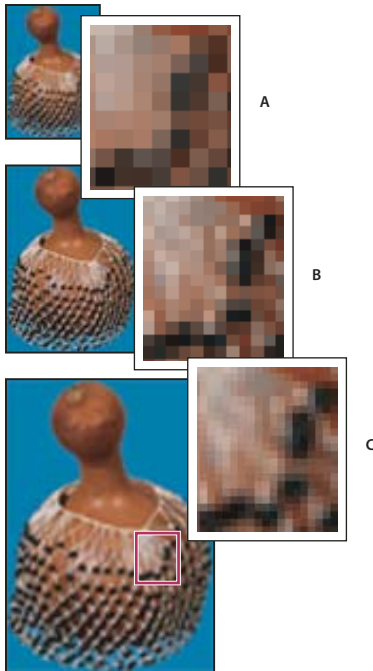

Resampling pixels
A. Downsampled **B.** Original **C.** Resampled up (selected pixels displayed for each set of images)

Keep in mind that resampling can result in poorer image quality. For example, when you resample an image to larger pixel dimensions, the image loses some detail and sharpness. Applying the Unsharp Mask filter to a resampled image can help refocus the image details.

You can avoid the need for resampling by scanning or creating the image at a sufficiently high resolution. If you want to preview the effects of changing pixel dimensions on-screen or to print proofs at different resolutions, resample a duplicate of your file.

Photoshop resamples images using an *interpolation method* to assign color values to any new pixels based on the color values of existing pixels. You can choose which method to use in the Image Size dialog box.

Nearest Neighbor A fast but less precise method that replicates the pixels in an image. This method is for use with illustrations containing edges that are not anti-aliased, to preserve hard edges and produce a smaller file. However, this method can produce jagged effects, which become apparent when you distort or scale an image or perform multiple manipulations on a selection.

Bilinear A method that adds pixels by averaging the color values of surrounding pixels. It produces medium-quality results.

Bicubic A slower but more precise method based on an examination of the values of surrounding pixels. Using more complex calculations, Bicubic produces smoother tonal gradations than Nearest Neighbor or Bilinear.

Bicubic Smoother A good method for enlarging images based on Bicubic interpolation but designed to produce smoother results.

Bicubic Sharper A good method for reducing the size of an image based on Bicubic interpolation with enhanced sharpening. This method maintains the detail in a resampled image. If Bicubic Sharper oversharpens some areas of an image, try using Bicubic.

 You can specify a default interpolation method to use whenever Photoshop resamples image data. Choose *Edit > Preferences > General (Windows) or Photoshop > Preferences > General (Mac OS)*, and then choose a method from the *Image Interpolation Methods* menu.

See also

“[Sharpen images](#)” on page 209

Change pixel dimensions of an image

Changing an image’s pixel dimensions affects not only its on-screen size but also its image quality and its printed characteristics—either its printed dimensions or its image resolution.

- 1 Choose *Image > Image Size*.
- 2 To maintain the current ratio of pixel width to pixel height, select *Constrain Proportions*. This option automatically updates the width as you change the height, and vice versa.
- 3 Under *Pixel Dimensions*, enter values for *Width* and *Height*. To enter values as percentages of the current dimensions, choose *Percent* as the unit of measurement. The new file size for the image appears at the top of the *Image Size* dialog box, with the old file size in parentheses.
- 4 Make sure that *Resample Image* is selected, and choose an interpolation method.
- 5 If your image has layers with styles applied to them, select *Scale Styles* to scale the effects in the resized image. This option is available only if you selected *Constrain Proportions*.
- 6 When you finish setting options, click *OK*.

 For best results when you produce a smaller image, *downsample and apply the Unsharp Mask filter*. To produce a larger image, *rescan the image at a higher resolution*.

Change the print dimensions and resolution

When creating an image for print media, it’s useful to specify image size in terms of the printed dimensions and the image resolution. These two measurements, referred to as the *document size*, determine the total pixel count and therefore the file size of the image; document size also determines the base size at which an image is placed into another application. You can further manipulate the scale of the printed image using the *Print* command; however, changes you make using the *Print* command affect only the printed image, not the document size of the image file.

If you turn on resampling for the image, you can change print dimensions and resolution independently (and change the total number of pixels in the image). If you turn off resampling, you can change either the dimensions or the resolution—Photoshop adjusts the other value automatically to preserve the total pixel count. For the highest print quality, it’s generally best to change the dimensions and resolution first, without resampling. Then resample only as necessary.

- 1 Choose *Image > Image Size*.
- 2 Change the print dimensions, image resolution, or both:
 - To change only the print dimensions or only the resolution and adjust the total number of pixels in the image proportionately, select *Resample Image* and then choose an interpolation method.
 - To change the print dimensions and resolution without changing the total number of pixels in the image, deselect *Resample Image*.
- 3 To maintain the current ratio of image width to image height, select *Constrain Proportions*. This option automatically changes the width as you change the height, and vice versa.

- 4 Under Document Size, enter new values for the height and width. If desired, choose a new unit of measurement. Note that for Width, the Columns option uses the width and gutter sizes specified in the Units & Rulers preferences.
- 5 For Resolution, enter a new value. If desired, choose a new unit of measurement.



To restore the initial values displayed in the Image Size dialog box, hold down Alt (Windows) or Option (Mac OS), and click Reset.

See also

[“Position and scale images”](#) on page 476

[“Print images”](#) on page 474

[“Specify columns for an image”](#) on page 37

[“Selecting halftone screen attributes”](#) on page 483

Determine a suggested resolution for an image

If you plan to print your image using a halftone screen, the range of suitable image resolutions depends on the screen frequency of your output device. Photoshop can determine a recommended image resolution based on the screen frequency of your output device.

Note: If your image resolution is more than 2.5 times the screen ruling, an alert message appears when you try to print the image. This means that the image resolution is higher than necessary for the printer. Save a copy of the file, and then reduce the resolution.

- 1 Choose Image > Image Size.
- 2 Click Auto.
- 3 For Screen, enter the screen frequency for the output device. If necessary, choose a different unit of measurement. Note that the screen value is used only to calculate the image resolution, not to set the screen for printing.

Note: To specify the halftone screen ruling for printing, you must use the Halftone Screens dialog box, accessible through the Print command.

- 4 For Quality, select an option:

Draft Produces a resolution that is the same as the screen frequency (no lower than 72 pixels per inch).

Good Produces a resolution 1.5 times the screen frequency.

Best Produces a resolution 2 times the screen frequency.

View the print size on-screen

- ❖ Do one of the following:
 - Choose View > Print Size.
 - Select the Hand tool or Zoom tool, and click Print Size in the options bar.

The image is redisplayed in its approximate printed size, as specified in the Document Size area of the Image Size dialog box. The size and resolution of your monitor affect the on-screen print size.

Acquiring images from cameras and scanners

Acquiring digital images from cameras

You can copy images to your computer by connecting your camera or a media card reader to your computer.

- Use the Get Photos From Camera command in Adobe® Bridge® CS4 to download photos, and to organize, rename, and apply metadata to them.
- If your camera or the card reader appears as a drive on your computer, copy images directly to your hard disk or into Adobe Bridge.
- Use the software that came with your camera, Windows Image Acquisition (WIA), or Image Capture (Mac OS). For more information on using Windows Image Acquisition or Image Capture, see your computer documentation.

Import images from a digital camera using WIA (Windows only)

Certain digital cameras import images using Windows Image Acquisition (WIA) support. When you use WIA, Photoshop works with Windows and your digital camera or scanner software to import images directly into Photoshop.

- 1 Choose File > Import > WIA Support.
- 2 Choose a destination in which to save your image files on your computer.
- 3 Make sure that Open Acquired Images in Photoshop is selected. If you are importing a large number of images, or if you want to edit the images later, deselect Open Acquired Images.
- 4 To save the imported images directly into a folder whose name is the current date, select Unique Subfolder.
- 5 Click Start.
- 6 Select the digital camera from which to import images.

Note: If the name of your camera does not appear in the submenu, verify that the software and drivers were properly installed and that the camera is connected.

- 7 Choose the image or images you want to import:
 - Click the image from the list of thumbnails to import the image.
 - Hold down Shift and click multiple images to import them at the same time.
 - Click Select All to import all available images.
- 8 Click Get Picture to import the image.

Importing scanned images

Make sure to install the software necessary for your scanner. Some scanner software lets you designate Photoshop as the external editor or viewer for an image after a scanning is completed. Other scanning software saves the image as a file on your computer that can be opened in Photoshop.

Note: Scanner drivers are supported by the scanner manufacturer, not Adobe® Systems Incorporated. If you have problems with scanning, make sure that you are using the latest version of the scanner driver and software.

You can also import scanned images directly from any scanner that has a Photoshop-compatible plug-in module. To import the scan using a plug-in module, choose the scanner name from the File > Import submenu. See your scanner documentation for instructions on installing the scanner plug-in. Or, use the scanner manufacturer's software to scan your images, and save the images as TIFF, PICT, or BMP files. Then open the files in Photoshop.

Note: To import an image using the TWAIN interface, install the optional TWAIN plug-in. The plug-in is available in the Goodies folder on your installation disc.

See also

[“About plug-in modules”](#) on page 44

[“Determine scan resolution for printing”](#) on page 487

Import images from a scanner using WIA Support

- 1 Choose File > Import > WIA Support.
- 2 Choose a destination on your computer for saving your image files.
- 3 Click Start.
- 4 Make sure that Open Acquired Images in Photoshop is selected. If you have a large number of images to import, or if you want to edit the images at a later time, deselect it.
- 5 Make sure that Unique Subfolder is selected if you want to save the imported images directly into a folder whose name is the current date.
- 6 Select the scanner that you want to use.

Note: If the name of your scanner does not appear in the submenu, verify that the software and drivers were properly installed and that the scanner is connected.

- 7 Choose the kind of image you want to scan:

Color Picture Uses the default settings for scanning color images.

Grayscale Picture Uses the default settings for scanning grayscale images.

Black And White Picture or Text Uses the default settings.

Adjust The Quality Of The Scanned Picture Uses custom settings.

- 8 Click preview to view the scan. If necessary, drag the handles of the bounding box to adjust the size of the crop.
- 9 Click Scan.
- 10 The scanned image is saved in BMP format.

Creating, opening, and importing images

Create a image

- 1 Choose File > New.
- 2 In the New dialog box, type a name for the image.
- 3 (Optional) Choose document size from the Preset menu.

Note: To create a document with the pixel dimensions set for a specific device, click the Device Central button.

- 4 Set the width and height by choosing a preset from the Size menu or entering values in the Width and Height text boxes.



To match the width, height, resolution, color mode, and bit depth of the new image to that of any open image, choose a filename from the bottom section of the Preset menu.

5 Set the Resolution, Color Mode, and bit depth.

If you've copied a selection to the clipboard, the image dimensions and resolution are automatically based on that image data.

6 Select a canvas color option:

White Fills the background layer with white, the default background color.

Background Color Fills the background layer with the current background color.

Transparent Makes the first layer transparent, with no color values. The resulting document has a single, transparent layer as its contents.

7 (Optional) If necessary, click the Advanced button to display more options.

8 (Optional) Under Advanced, choose a color profile, or choose Don't Color Manage This Document. For Pixel Aspect Ratio, choose Square unless you're using the image for video. In that case, choose another option to use non-square pixels.

9 When you finish, you can save the settings as a preset by clicking Save Preset, or you can click OK to open the new file.

See also

["Color modes"](#) on page 106

["About creating images for video"](#) on page 532

["About foreground and background colors"](#) on page 114

Open files

You can open files using the Open command and Open Recent command. You can also open files into Photoshop from Adobe Bridge or Adobe® Photoshop® Lightroom™.

When opening certain files, such as camera raw and PDF, you specify settings and options in a dialog box before the files completely open in Photoshop.

In addition to still images, Photoshop® CS4 Extended users can open and edit 3D files, video and image sequence files. For more information, see ["Importing video files and image sequences \(Photoshop Extended\)"](#) on page 537.

Note: *Photoshop uses plug-in modules to open and import many file formats. If a file format does not appear in the Open dialog box or in the File > Import submenu, you may need to install the format's plug-in module.*

Sometimes Photoshop may not be able to determine the correct format for a file. This can happen, for example, because the file has been transferred between two operating systems. Sometimes a transfer between Mac OS and Windows can cause the file format to be mislabeled. In such cases, you must specify the correct format in which to open the file.

 *You can retain (where possible) layers, masks, transparency, compound shapes, slices, image maps, and editable type when bringing your Illustrator art into Photoshop. In Illustrator, export the art in the Photoshop (PSD) file format. If your Illustrator art contains elements that Photoshop doesn't support, the appearance of the artwork is preserved, but the layers are merged and the artwork is rasterized.*

See also

["About plug-in modules"](#) on page 44

["Processing images with Camera Raw"](#) on page 81

Open a file using the Open command

- 1 Choose File > Open.
- 2 Select the name of the file you want to open. If the file does not appear, select the option for showing all files from the Files Of Type (Windows) or Enable (Mac OS) pop-up menu.
- 3 Click Open. In some cases, a dialog box appears, letting you set format-specific options.

Note: If a color profile warning message appears, specify whether to use embedded profile as the working space, convert the document color to working space, or reverse the embedded profile. For more information, see “[Color-managing imported images](#)” on page 132.

Open a recently used file

- ❖ Choose File > Open Recent, and select a file from the submenu.

Note: To specify the number of files listed in the Open Recent menu, change the Recent File List Contains option in the File Handling preferences. Choose Edit > Preferences > File Handling (Windows), or Photoshop > Preferences > File Handling (Mac OS).

Specify the file format in which to open a file

If a file was saved with an extension that doesn't match its true format (for example, a PSD file saved with a .gif extension), or has no extension, Photoshop may not be able to open the file. Selecting the correct format will allow Photoshop to recognize and open the file.

- ❖ Do one of the following:
 - (Windows) Choose File > Open As, and select the file you want to open. Then choose the desired format from the Open As pop-up menu, and click Open.
 - (Mac OS) Choose File > Open, and choose All Documents from the Show pop-up menu. Then select the file you want to open, choose the desired file format from the Format pop-up menu, and click Open.

Note: If the file does not open, then the chosen format may not match the file's true format, or the file may be damaged.

Open PDF files

Adobe Portable Document Format (PDF) is a versatile file format that can represent both vector and bitmap data. It has electronic document search and navigation features. PDF is the primary format for Adobe Illustrator and Adobe Acrobat.

Some PDF files contain a single image, and others contain multiple pages and images. When you open a PDF file in Photoshop, you can choose which pages or images to open and specify rasterization options.

You can also import PDF data using the Place command, the Paste command, and the drag-and-drop feature. The page or image is placed on a separate layer as a Smart Object.

Note: The following procedure is only for opening generic PDF files in Photoshop. You don't need to specify options in the Import PDF dialog box, when opening Photoshop PDF files.

- 1 Do one of the following:
 - (Photoshop) Choose File > Open.
 - (Bridge) Select the PDF file and choose File > Open With > Adobe Photoshop CS4. Skip to step 3.
- 2 In the Open dialog box, select the name of the file, and click Open.
- 3 Under Select in the Import PDF dialog box, select Pages or Images, depending on what elements of the PDF document you want to import.

4 Click the thumbnails to select the pages or images you want to open. Shift-click to select more than one page or image. The number of selected items appears under the preview window. If you're importing images, skip to step 8.

Note: Use the Thumbnail Size menu to adjust the thumbnail view in the preview window. The Fit Page option fits one thumbnail in the preview window. A scroll bar appears if there are multiple items.

5 To give the new document a name, type it in the Name text box. If you're importing more than one page or image, multiple documents open with the base name followed by a number.

6 Under Page Options, choose from the Crop To menu to specify what part of the PDF document to include:

Bounding Box Crops to the smallest rectangular region that includes all the text and graphics of the page. This option eliminates extraneous white space and any document elements outside the Trim Box.

Note: Bounding Box will not crop white space that is part of a background created by the source application.

Media Box Crops to the original size of the page.

Crop Box Crops to the clipping region (crop margins) of the PDF file.

Bleed Box Crops to the region specified in the PDF file for accommodating limitations inherent in production processes such as cutting, folding, and trimming.

Trim Box Crops to the region specified for the intended finished size of the page.

Art Box Crops to the region specified in the PDF file for placing the PDF data into another application.

7 Under Image Size, enter values (if necessary) for Width and Height:

- To preserve the aspect ratio of the pages as they're scaled to fit within the rectangle defined by the Width and Height values, select Constrain Proportions.
- To scale the pages exactly to the Width and Height values, deselect Constrain Proportions. Some distortion might occur when the pages are scaled.

When more than one page is selected, the Width and Height text boxes display the maximum width and height values of the selected pages. All pages are rendered at their original size if Constrain Proportions is selected and you don't change the Width and Height values. Changing the values will scale all pages proportionately as they're rasterized.

8 Specify the following options under Image Size:

Resolution Sets the resolution for the new document. See also "[About pixel dimensions and resolution](#)" on page 56.

Mode Sets the color mode for the new document. See also "[Color modes](#)" on page 106.

Bit Depth Sets the bit depth for the new document. See also "[Bit depth](#)" on page 55.

The Width and Height values plus the Resolution determine the final pixel dimension of resulting document.

9 To suppress color profile warnings, select Suppress Warning.

10 Click OK.

See also

["PDF"](#) on page 461

["About Smart Objects"](#) on page 310

["Placing files"](#) on page 69

["Copy between applications"](#) on page 263

Open an EPS file

Encapsulated PostScript (EPS) can represent both vector and bitmap data and is supported by virtually all graphic, illustration, and page-layout programs. The Adobe application that primarily produces PostScript artwork is Adobe Illustrator. When you open an EPS file containing vector art, it is *rasterized*—the mathematically defined lines and curves of the vector artwork are converted into the pixels or bits of a bitmap image.

You can also bring PostScript artwork into Photoshop using the Place command, the Paste command, and the drag-and-drop feature.

- 1 Choose File > Open.
- 2 Select the file you want to open, and click Open.
- 3 Indicate the desired dimensions, resolution, and mode. To maintain the same height-to-width ratio, select Constrain Proportions.
- 4 To minimize jagged lines at the edges of artwork, select Anti-aliased.

See also

“Placing files” on page 69

“Copy between applications” on page 263

Adobe Version Cue

Adobe Version Cue® CS4 is an asset management system that lets designers work collaboratively on a set of common files without having to change their workflow significantly. Designers can easily track and manipulate multiple versions of files.

Version Cue handles the following tasks:

- Creating versions of your files
- Enabling workgroup collaboration (file sharing, version control, the ability to check files in and out)
- Organizing files into private or shared projects
- Providing thumbnails so you can browse and view files
- Organizing data so you can view and search on file information, version comments, and file status
- Creating and managing user access, projects, and PDF reviews by way of Version Cue Server Administration

Version Cue consists of two pieces: the Adobe Version Cue Server and Adobe Drive.

Adobe Version Cue Server The Version Cue Server can be installed locally or on a dedicated computer. It hosts Version Cue projects and PDF reviews.

Adobe Drive Adobe Drive connects to Version Cue CS4 servers. The connected server appears like a hard drive or mapped network drive in Windows Explorer, Mac OS Finder, and dialog boxes such as Open and Save As.

Note: The “Use Adobe Dialog” option that appears in CS3 applications does not appear in CS4 applications. This option is no longer necessary. Connecting to the Version Cue Server using Adobe Drive lets you view project files from any application.

Version Cue is included with Adobe Creative Suite 4 Design Premium and Standard, Adobe Creative Suite 4 Web Premium and Standard, Adobe Creative Suite 4 Production Premium, and Adobe Creative Suite 4 Master Collection.

Version Cue enables versioning and asset management in all applications, but it includes enhanced features for the following products: Adobe Flash®, Adobe Illustrator®, Adobe InDesign®, Adobe InCopy®, Adobe Photoshop®, and Adobe Bridge. When you use any of these applications to open a file stored on a Version Cue server, the file is checked out automatically. For all other applications, use the context menu to check in and check out files manually.

For a video overview on Version Cue, see www.adobe.com/go/lrvid4037_vc.

Placing files



The Place command adds a photo, art, or any Photoshop-supported file as a Smart Object to your document. Smart Objects can be scaled, positioned, skewed, rotated, or warped without degrading the image.

Place a file in Photoshop

- 1 Open the Photoshop document that is the destination for the placed art or photo.
- 2 Do one of the following:
 - (Photoshop) Choose File > Place, select the file you want to place, and click Place.
 - (Bridge) Select the file and choose File > Place > In Photoshop.
- 3 If you are placing a PDF or Illustrator (AI) file, the Place PDF dialog box appears. Select the page or image you want to place, set the Crop options, and click OK. For more information on the Place PDF dialog box options, see “[Place PDF or Illustrator files in Photoshop](#)” on page 70.

The placed artwork appears inside a bounding box at the center of the Photoshop image. The artwork maintains its original aspect ratio; however, if the artwork is larger than the Photoshop image, it is resized to fit.

Note: In addition to the Place command, you can also add Adobe Illustrator art as a Smart Object by copying and pasting the art from Illustrator into a Photoshop document. See “[Paste Adobe Illustrator art into Photoshop](#)” on page 70.

- 4 (Optional) Reposition or transform the placed artwork by doing any of the following:
 - To reposition the placed art, position the pointer inside the bounding box of the placed artwork and drag, or in the options bar, enter a value for X to specify the distance between the center point of the placed artwork and the left edge of the image. Enter a value for Y to specify the distance between the center point of the placed artwork and the top edge of the image.
 - To scale the placed art, drag one of the corner handles of the bounding box or enter values for W and H in the options bar. When dragging, hold down the Shift key to constrain proportions.
 - To rotate the placed art, position the pointer outside the bounding box (the pointer turns into a curved arrow) and drag, or enter a value (in degrees) for the Rotation option  in the options bar. The artwork rotates around the center point of the placed artwork. To adjust the center point, drag it to a new location, or click a handle on the Center Point icon  in the options bar.
 - To skew the placed art, hold down Ctrl (Windows) or Command (Mac OS) and drag a side handle of the bounding box.
 - To warp the placed art, choose Edit > Transform > Warp and then choose a warp from the Warp Style pop-up menu in the options bar.

If you choose Custom from the Warp Style pop-up menu, drag the control points, a segment of the bounding box or mesh, or an area within the mesh to warp the image.

- 5 If you're placing a PDF, EPS, or Adobe Illustrator file, set the Anti-alias option in the options bar as desired. To blend edge pixels during rasterization, select the Anti-alias option. To produce a hard-edged transition between edge pixels during rasterization, deselect the Anti-alias option.
- 6 Do one of the following:
 - Click Commit ✓ in the options bar or press Enter (Windows) or Return (Mac OS) to commit the placed artwork to a new layer.
 - Click Cancel ⓧ in the options bar, or press Esc to cancel the placement.

See also

[“Scale, rotate, skew, distort, apply perspective, or warp”](#) on page 216

[“Warp an item”](#) on page 219

Place PDF or Illustrator files in Photoshop

When you place a PDF or Adobe Illustrator file, use the Place PDF dialog box to set options for placing the artwork.

- 1 With the destination Photoshop document open, place a PDF or Adobe Illustrator file.
- 2 Under Select in the Place PDF dialog box, select Page or Image, depending on what elements of the PDF document you want to import. If the PDF file has multiple pages or images, click the thumbnail of the page or file you want to place.

Note: Use the Thumbnail Size menu to adjust the thumbnail view in the preview window. The Fit Page option fits one thumbnail in the preview window. A scroll bar appears if there are multiple items.

- 3 Under Options, choose from the Crop To menu to specify what part of the PDF or Illustrator (AI) document to include:

Bounding Box Crops to the smallest rectangular region that includes all the text and graphics of the page. This option eliminates extraneous white space.

Media Box Crops to the original size of the page.

Crop Box Crops to the clipping region (crop margins) of the PDF file.

Bleed Box Crops to the region specified in the PDF file for accommodating limitations inherent in production processes such as cutting, folding, and trimming.

Trim Box Crops to the region specified for the intended finished size of the page.

Art Box Crops to the region specified in the PDF file for placing the PDF data into another application.

- 4 Click OK to close the Place PDF dialog box.
- 5 If necessary, set any positioning, scaling, skewing, rotating, warping, or anti-aliasing options in the options bar.
- 6 Click Commit ✓ to place the artwork as a Smart Object on a new layer of the destination document.

Paste Adobe Illustrator art into Photoshop

You can copy art from Adobe Illustrator and paste it into a Photoshop document.

- 1 In Adobe Illustrator, specify preferences for the copy-and-paste behavior:
 - To automatically rasterize the art when pasting it into a Photoshop document, turn off the PDF and the AICB (No Transparency Support) options in the File Handling & Clipboard preferences.

- To paste the art as a Smart Object, rasterized image, path, or shape layer, turn on the PDF and the AICB (No Transparency Support) options in the File Handling & Clipboard preferences.
- 2 Open a file in Adobe Illustrator, select the art you want to copy, and choose Edit > Copy.
 - 3 In Photoshop, open the document that you want to paste the Adobe Illustrator art into and then choose Edit > Paste.

Note: If the PDF and the AICB (No Transparency Support) options are turned off in the File Handling & Clipboard preferences of Adobe Illustrator, the art is automatically rasterized as it's pasted into the Photoshop document. You can skip the rest of the steps in this procedure.

- 4 In the Paste dialog box, select how you want to paste the Adobe Illustrator art and then click OK:

Smart Object Pastes the art as a Vector Smart Object that can be scaled, transformed, or moved without degrading the image. As the art is placed, its file data is embedded in the Photoshop document on a separate layer.

Pixels Pastes the art as pixels that can be scaled, transformed, or moved before it is rasterized and placed on its own layer in the Photoshop document.

Path Pastes the art as a path that can be edited with the pen tools, Path Selection tool, or Direct Selection tool. The path is pasted into the layer that's selected in the Layers panel.

Shape Layer Pastes the art as a new shape layer (a layer containing a path filled with the foreground color).

- 5 If you selected Smart Object or Pixels in the Paste dialog box, make any transformations you wish, and then click Enter or Return to place the art.

See also

[“Placing files”](#) on page 69

[“About Smart Objects”](#) on page 310

[“Path segments, components, and points”](#) on page 372

[“Create a shape on a shape layer”](#) on page 360

High dynamic range images

About high dynamic range images

The dynamic range (ratio between dark and bright regions) in the visible world far exceeds the range of human vision and of images that are displayed on a monitor or printed. But whereas human eyes can adapt to very different brightness levels, most cameras and computer monitors can capture and reproduce only a fixed dynamic range. Photographers, motion picture artists, and others working with digital images must be selective about what's important in a scene because they are working with a limited dynamic range.

High dynamic range (HDR) images open up a world of possibilities because they can represent the entire dynamic range of the visible world. Because all the luminance values in a real-world scene are represented proportionately and stored in an HDR image, adjusting the exposure of an HDR image is like adjusting the exposure when photographing a scene in the real world. This capability lets you create blurs and other real-world lighting effects that look realistic. Currently, HDR images are used mostly in motion pictures, special effects, 3D work, and some high-end photography.

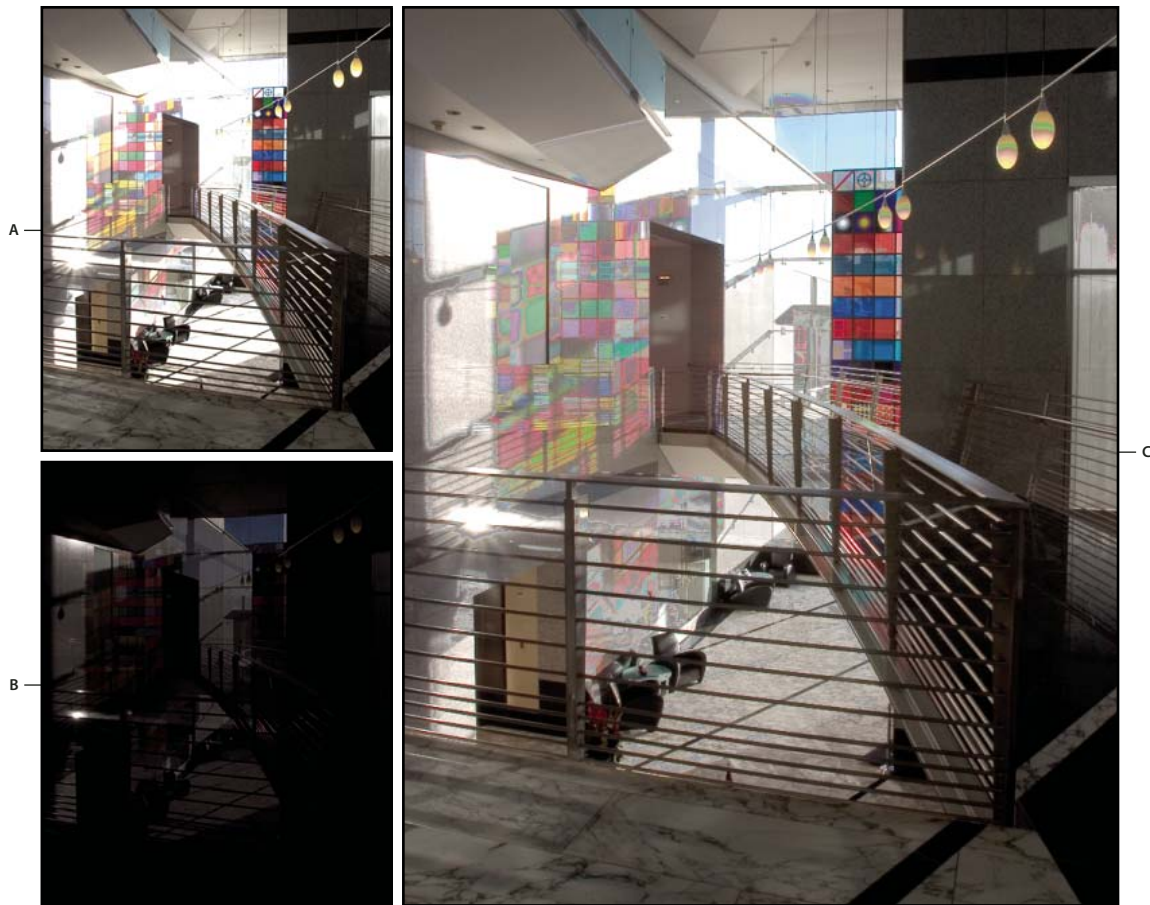

Merging images of different exposures to create an HDR image
A. Image with shadow detail but highlights clipped **B.** Image with highlight detail but shadows clipped **C.** HDR image containing the dynamic range of the scene

In Photoshop, the luminance values of an HDR image are stored using a floating-point numeric representation that's 32 bits long (32-bits-per-channel). The luminance values in an HDR image are directly related to the amount of light in a scene. This is not so with (non-floating point) 16-bits-per-channel (bpc) and 8-bpc image files, which can store luminance values only from black to paper white; this represents an extremely small segment of the dynamic range in the real world.

Photoshop offers layers support for 32-bpc images, and many tools, filters, and commands can be used with 32-bpc images. (For more information, see below.) In addition, you can specify new images as 32 bpc in the New dialog box.

You can also paint on 32-bpc images in Photoshop. The Adobe Color Picker lets you specify colors that have a brightness intensity that exceeds 1.0 (the equivalent of the 255 level in an 8-bit RGB document). See also “[About the HDR Color Picker \(Photoshop Extended\)](#)” on page 76.

You can create an HDR image using multiple photographs, each captured at a different exposure. In Photoshop, the Merge To HDR command lets you create HDR images from multiple photographs. Because an HDR image contains brightness levels that far exceed the display capabilities of a standard 24-bit monitor or the range of tones in a printed image, Photoshop lets you adjust the preview of the HDR image so it can be viewed on a computer monitor. If you need to print the image or use Photoshop tools and filters that don't work with HDR images, you can convert the HDR image to an 8- or 16-bpc image.

For a video on editing and merging images from Lightroom, see www.adobe.com/go/lrvid4121_ps.

Photoshop support for 32-bpc images

Use the following tools, adjustments, and filters with 32-bpc HDR images:

Adjustments Levels, Exposure, Hue/Saturation, Channel Mixer, Photo Filter.

Note: Although the Exposure command can be used with 8- and 16-bpc images, it is designed for making exposure adjustments to 32-bpc HDR images.

Blend Modes Normal, Dissolve, Darken, Multiply, Lighten, Color Darken, Linear Dodge (Add), Color Lighter, Difference, Hue, Saturation, Color, and Luminosity.

Create new 32-bpc documents In the New dialog box, 32 bit is an option in the bit depth pop-up menu to the right of the Color Mode pop-up menu.

Edit menu commands All commands including Fill, Stroke, Free Transform, and Transform.

File Formats Photoshop (PSD, PSB), Radiance (HDR), Portable Bit Map (PBM), OpenEXR, and TIFF.

Note: Although Photoshop cannot save an HDR image in the LogLuv TIFF file format, it can open and read a LogLuv TIFF file.

Filters Average, Box Blur, Gaussian Blur, Motion Blur, Radial Blur, Shape Blur, Surface Blur, Add Noise, Differences Clouds, Lens Flare, Smart Sharpen, Unsharp Mask, Emboss, De-Interlace, NTSC Colors, High Pass, Maximum, Minimum, and Offset.

Image commands Duplicate, Image Size, Canvas Size, Image Rotation, Calculation, Variable, and Trim.

View Pixel Aspect Ratio (Custom Pixel Aspect Ratio, Delete Pixel Aspect Ratio, Reset Pixel Aspect Ratio, etc.)

Layers New layers, duplicate layers, adjustment layers (Levels, Vibrance, Hue/Saturation, Channel Mixer, Photo Filter, and Exposure), fill layers, layer masks, layer styles, supported blending modes, and Smart Objects.

Modes RGB Color, Grayscale, conversion to 8 Bits/Channel or 16 Bits/Channel.

Pixel Aspect Ratio Support for square and non-square documents.

Selections Invert, Modify Border, Transform Selection, Save Selection and Load Selection.

Tools All tools in the toolbox except: Magnetic Lasso, Magic Wand, Spot Healing Brush, Healing Brush, Red Eye, Color Replacement, Art History Brush, Magic Eraser, Background Eraser, Paint Bucket, Dodge, Burn, and Sponge. Some tools work with supported blend modes only.

To work with certain Photoshop features, you can convert a 32-bpc image to a 16-bpc or an 8-bpc image. Do a Save As and convert a copy of the image file to preserve the original.

Merge images to HDR

Use the Merge To HDR command to combine multiple images (with different exposures) of the same image or scene, capturing the dynamic range of a scene in a single HDR image. You can choose to save the merged image as a 32-bpc HDR image.

Note: It's also possible to use the Merge To HDR command to save the merged image as an 8- or 16-bpc image. However, only a 32-bpc image can store all the HDR image data; 8- and 16-bpc images will be clipped.

For information on taking photos to merge into HDR images, see Take photos for merging to HDR, below.

1 Do one of the following:

- (Photoshop) Choose File > Automate > Merge To HDR.
- (Bridge) Select the images you want to use and choose Tools > Photoshop > Merge To HDR. Skip to step 3.

2 In the Merge To HDR dialog box, click Browse, browse to select the images, and click Open.

To remove an item, select it in the Merge To HDR dialog box and click Remove.

Note: If you want to add a folder of images or images that are open in Photoshop, choose Folder or Open Files from the Use menu.

3 (Optional) Select the Attempt To Automatically Align Source Images option if you held the camera in your hands when you photographed the multiple images.

4 Click OK.

A second Merge To HDR dialog box displays thumbnails of the images being used in the merged result, a preview of the merged result, a Bit Depth menu, and a slider for setting the white point preview.

5 If necessary, do one of the following to set the view options for the merged result preview:

- Click the Minus or Plus buttons below the preview image to zoom out or zoom in.
- Choose a view percentage or mode from the pop-up menu below the preview image.

6 Choose a bit depth for the merged image from the Bit Depth menu.

Be sure to choose 32 Bits/Channel if you want the merged image to store the entire dynamic range data of the HDR image. 8-bits and (non-floating point) 16-bpc images files cannot store the entire range of luminance values in an HDR image.

7 Move the slider below the histogram to preview the merged image.

Moving the slider adjusts the image preview only. All the HDR image data remains intact in the merged image file. If you're saving the merged image as 32-bpc, the preview adjustment is stored in the HDR image file and applied whenever the file is opened in Photoshop. The preview adjustment is always accessible and adjustable by choosing View > 32-Bit Preview Options.

8 Click OK to create the merged image.

If you chose to save the merged image as an 8-bits or 16-bpc image, the HDR Conversion dialog box opens. Make the exposure and contrast corrections to produce an image with the dynamic range (tonal range) you want. For more information, see [“Convert from 32 bits to 8 or 16 bpc”](#) on page 75.

Take photos for merging to HDR

Keep the following tips in mind when you take photos to be combined with the Merge To HDR command:

- Secure the camera to a tripod.
- Take enough photos to cover the full dynamic range of the scene. You can try taking at least five to seven photos, but you might need to take more exposures depending on the dynamic range of the scene. The minimum number of photos should be three.
- Vary the shutter speed to create different exposures. Changing the aperture changes the depth of field in each exposure and can produce lower-quality results. Changing the ISO or aperture may also cause noise or vignetting in the image.
- In general, don't use your camera's auto-bracket feature, because the exposure changes are usually too small.
- The exposure differences between the photos should be one or two EV (exposure value) steps apart (equivalent to about one or two f-stops apart).
- Don't vary the lighting; for instance, don't use a flash in one exposure but not the next.
- Make sure that nothing is moving in the scene. Exposure Merge works only with differently exposed images of the identical scene.

Adjust dynamic range view for HDR images

The dynamic range of HDR images exceeds the display capabilities of standard computer monitors. When you open an HDR image in Photoshop, it can look very dark or washed out. Photoshop lets you adjust the preview so that the monitor displays an HDR image whose highlights and shadows aren't washed out or too dark. The preview settings are stored in the HDR image file (PSD, PSB, and TIFF only) and are applied whenever the file is opened in Photoshop. Preview adjustments don't edit the HDR image file, all the HDR image information remains intact. Use the Exposure adjustment (Image > Adjustments > Exposure) to make exposure edits to the 32-bpc HDR image.

 To view 32-bit readouts in the Info panel, click the Eyedropper icon in the Info panel and choose 32-Bit from the pop-up menu.

- 1 Open a 32-bpc HDR image in Photoshop, and choose View > 32-Bit Preview Options.
- 2 In the 32-bit Preview Options dialog box, choose an option from the Method menu:

Exposure And Gamma Adjusts the brightness and contrast.

Highlight Compression Compresses the highlight values in the HDR image so they fall within the luminance values range of the 8- or 16-bpc image file.

- 3 If you chose Exposure And Gamma, move the Exposure and Gamma sliders to adjust the brightness and contrast of the image preview.
- 4 Click OK.

 You can also adjust the preview of an HDR image open in Photoshop by clicking the triangle in the status bar of the document window and choosing 32-Bit Exposure from the pop-up menu. Move the slider to set the white point for viewing the HDR image. Double-click the slider to return to the default exposure setting. Since the adjustment is made per view, you can have the same HDR image open in multiple windows, each with a different preview adjustment. Preview adjustments made with this method are not stored in the HDR image file.

See also

[“Adjust Exposure for HDR images”](#) on page 174

Convert from 32 bits to 8 or 16 bpc

HDR images contain luminance levels that far exceed the luminance data that can be stored in 8- or 16-bpc image files. You can make exposure and contrast corrections when converting a 32-bpc HDR image to 8 or 16 bpc to produce an image with the dynamic range (tonal range) you want.

- 1 Open a 32-bpc image and choose Image > Mode > 16 Bits/Channel or 8 Bits/Channel.
- 2 In the HDR Conversion dialog box, choose a method for adjusting the brightness and contrast in the image:

Exposure and Gamma Lets you manually adjust the brightness and contrast of the HDR image.

Highlight Compression Compresses the highlight values in the HDR image so they fall within the luminance values range of the 8- or 16-bpc image file. No further adjustments are necessary; this method is automatic. Click OK to convert the 32-bpc image.

Equalize Histogram Compresses the dynamic range of the HDR image while trying to preserve some contrast. No further adjustments are necessary; this method is automatic. Click OK to convert the 32-bpc image.

Local Adaptation Adjusts the tonality in the HDR image by calculating the amount of correction necessary for local brightness regions throughout the image.

- 3 (Optional) Click the arrow to display the toning curve and histogram. The histogram shows the luminance values in the original HDR image. The red tick marks along the horizontal axis are in 1 EV (approximately 1 f-stop) increments. The toning curve is active only for the Local Adaptation method.
- 4 Do any of the following:
 - If you chose Exposure and Gamma, move the Exposure slider to adjust the gain and move the Gamma slider to adjust the contrast.
 - If you chose Local Adaptation, move the Radius slider to specify the size of the local brightness regions. Move the Threshold slider to specify how far apart two pixels' tonal values must be before they're no longer part of the same brightness region. You can also use the Toning Curve and Histogram to make adjustments.

Note: The Toning Curve and Histogram usually lets you make limited changes from point to point and attempts to equalize your changes across the points. If you select the Corner option after inserting a point on the curve, the limit is removed and no equalization is performed when you insert and move a second point. You'll notice that the curve becomes angular at a point with the Corner option applied.

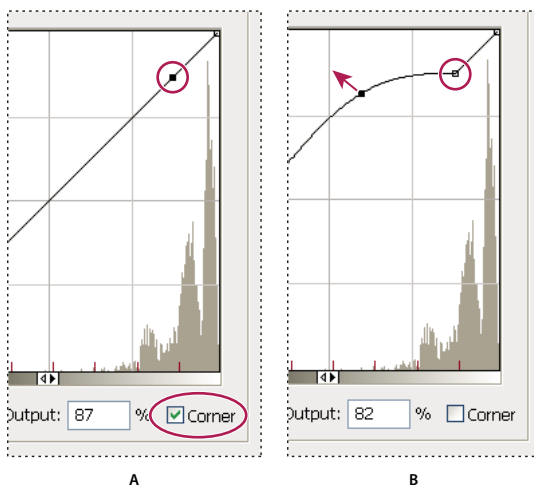

Toning Curve and Histogram adjustment using the Corner option
A. Inserting a point and selecting the Corner option. **B.** Adjusting new point makes the curve angular at the point where the Corner option is used.

- 5 (Optional) To save your 32-bit toning options as a file, click Save. Type a name for the file in the Save dialog box and click Save.
- You can reuse the saved 32-bit toning option file. Click Load to convert another 32-bpc image to an 8- or 16-bpc image.
- 6 Click OK to convert the 32-bpc image.

See also

“[Curves overview](#)” on page 163

About the HDR Color Picker (Photoshop Extended)

The HDR Color Picker allows you to accurately view and select colors for use in 32-bit HDR images. As in the regular Adobe Color Picker, you select a color by clicking a color field and adjusting the color slider. The Intensity slider allows you to adjust the brightness of a color to match the intensity of the colors in the HDR image you're working with. A Preview area lets you view swatches of a selected color to see how it will display at different exposures and intensities.

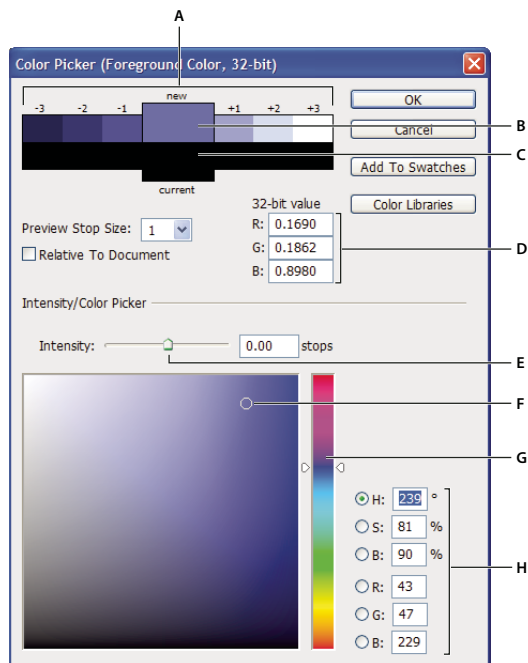

HDR Color Picker

A. Preview area B. Adjusted color C. Original color D. 32-bit floating point values E. Intensity slider F. Picked color G. Color slider H. Color values

See also

“[Adobe Color Picker overview](#)” on page 116

“[Adjust dynamic blue view for HDR images](#)” on page 75

Display the HDR Color Picker

- ❖ With a 32-bpc image open, do one of the following:
 - In the toolbox, click the foreground or background color selection box.
 - In the Color panel, click the Set Foreground Color or Set Background Color selection box.

The Color Picker is also available when features let you choose a color. For example, by clicking the color swatch in the options bar for some tools, or the eyedroppers in some color adjustment dialog boxes.

Choose Colors for HDR images

The lower part of the HDR Color Picker functions like the regular Color Picker does with 8- or 16-bit images. Click in the color field to select a color and move the color slider to change hues, or use the HSB or RGB fields to enter numeric values for a particular color. In the color field, brightness increases as you move from bottom to top, and saturation increases as you move from left to right.

Use the Intensity slider to adjust the brightness of the color. The color value plus the intensity value are converted to 32-bit floating point number values in your HDR document.

- 1 Select a color by clicking in the color field and moving the color slider, or by entering HSB or RGB numeric values, as in the Adobe Color Picker.
- 2 Adjust the Intensity slider to boost or reduce the color’s brightness. The new color swatch in the Preview scale at the top of the Color Picker shows the effect of increasing or decreasing stops for the selected color.

The Intensity Stops correspond inversely to exposure setting stops. If you boost the Exposure setting of the HDR image two stops, reducing the Intensity stops by two will maintain the same color appearance as if the HDR image exposure and the color intensity were both set to 0.

If you know the exact 32-bit RGB values for the color you want, you can enter them directly in the 32-bit value RGB fields.

3 (Optional) Adjust settings for the Preview area.

Preview Stop Size Sets the stop increments for each preview swatch. For example, a setting of 3 results in swatches of -9, -6, -3, +3, +6, +9. These swatches let you preview the appearance of your selected color at different exposure settings.

Relative to Document Select to adjust the preview swatches to reflect the current exposure setting for the image. For example, if the document exposure is set higher, the new preview swatch will be lighter than the color selected in the Color Picker's color field, to show the effect of the higher exposure on the selected color. If the current exposure is set to 0 (the default), checking or unchecking this option will not change the new swatch.

4 (Optional) Click Add to Swatches to add the selected color to the Swatches panel.

5 Click OK.

Paint on HDR images (Photoshop Extended)

You can edit and add effects to HDR/32-bpc images using any of the following Photoshop tools: Brush, Pencil, Pen, Shape, Clone Stamp, Pattern Stamp, Eraser, Gradient, Blur, Sharpen, Smudge, and History Brush. You can also use the Text tool to add 32-bpc text layers to an HDR image.

When editing or painting on HDR images, you can preview your work at different exposure settings using either the 32-Bit Exposure slider in the document info area or the 32-Bit Preview Options dialog box (View > 32-Bit Preview Options). The HDR Color Picker also lets you preview your selected foreground color at different intensity settings, to match different exposure settings in an HDR image.

1 Open an HDR image.

2 (Optional) Set the exposure for the image. See “[Adjust dynamic range view for HDR images](#)” on page 75.

3 For the Brush or Pencil tools, click the foreground color to open the HDR Color Picker and select a color. For the Text tool, click the color chip in the Text tool options bar to set the text color.

The Preview area of the HDR Color Picker helps you select and adjust a foreground color in relation to different exposure settings in the HDR image. See “[About the HDR Color Picker \(Photoshop Extended\)](#)” on page 76.

 *To view the effects of painting at different HDR exposures, use the Window > Arrange > New Window command to open simultaneous views of the same HDR image, then set each window to a different exposure using the Exposure slider in the document status bar area.*

Chapter 4: Camera Raw

Introduction to Camera Raw

About camera raw files

A *camera raw* file contains unprocessed, uncompressed grayscale picture data from a digital camera's image sensor, along with information about how the image was captured (metadata). Photoshop Camera Raw software interprets the camera raw file, using information about the camera and the image's metadata to construct and process a color image.

Think of a camera raw file as your photo negative. You can reprocess the file at any time, achieving the results that you want by making adjustments for white balance, tonal range, contrast, color saturation, and sharpening. When you adjust a camera raw image, the original camera raw data is preserved. Adjustments are stored as metadata in an accompanying sidecar file, in a database, or in the file itself (in the case of DNG format).

When you shoot JPEG files with your camera, the camera automatically processes the JPEG file to enhance and compress the image. You generally have little control over how this processing occurs. Shooting camera raw images with your camera gives you greater control than shooting JPEG images, because camera raw does not lock you into processing done by your camera. You can still edit JPEG and TIFF images in Camera Raw, but you will be editing pixels that were already processed by the camera. Camera raw files always contain the original, unprocessed pixels from the camera.

To shoot camera raw images, you must set your camera to save files in its own camera raw file format.

Note: The Photoshop Raw format (.raw) is a file format for transferring images between applications and computer platforms. Don't confuse Photoshop raw with camera raw file formats.

Digital cameras capture and store camera raw data with a linear tone response curve (gamma 1.0). Both film and the human eye have a nonlinear, logarithmic response to light (gamma greater than 2). An unprocessed camera raw image viewed as a grayscale image would seem very dark, because what appears twice as bright to the photosensor and computer seems less than twice as bright to the human eye.

For a list of supported cameras and for more information about Camera Raw, see www.adobe.com/go/learn_ps_cameraraw.

About Camera Raw

Camera Raw software is included as a plug-in with Adobe After Effects® and Adobe Photoshop, and also adds functionality to Adobe Bridge. Camera Raw gives each of these applications the ability to import and work with camera raw files. You can also use Camera Raw to work with JPEG and TIFF files.

Note: Camera Raw supports images up to 65,000 pixels long or wide and up to 512 megapixels. Camera Raw converts CMYK images to RGB upon opening. For a list of supported cameras, see www.adobe.com/go/learn_ps_cameraraw.

You must have Photoshop or After Effects installed to open files in the Camera Raw dialog box from Adobe Bridge. However, if Photoshop or After Effects is not installed, you can still preview the images and see their metadata in Adobe Bridge. If another application is associated with the image file type, it's possible to open the file in that application from Adobe Bridge.

Using Adobe Bridge, you can apply, copy, and clear image settings, and you can see previews and metadata for camera raw files without opening them in the Camera Raw dialog box. The preview in Adobe Bridge is a JPEG image generated using the current image settings; the preview is not the raw camera data itself, which would appear as a very dark grayscale image.

Note: A caution icon  appears in the thumbnails and preview image in the Camera Raw dialog box while the preview is generated from the camera raw image.

You can modify the default settings that Camera Raw uses for a particular model of camera. For each camera model, you can also modify the defaults for a particular ISO setting or a particular camera (by serial number). You can modify and save image settings as presets for use with other images.

When you use Camera Raw to make adjustments (including straightening and cropping) to a camera raw image, the image's original camera raw data is preserved. The adjustments are stored in either the Camera Raw database, as metadata embedded in the image file, or in a *sidecar* XMP file (a metadata file that accompanies a camera raw file). For more information, see “Specify where Camera Raw settings are stored” on page 100.

After you process and edit a camera raw file using the Camera Raw plug-in, an icon  appears in the image thumbnail in Adobe Bridge.

If you open a camera raw file in Photoshop, you can save the image in other image formats, such as PSD, JPEG, Large Document Format (PSB), TIFF, Cineon, Photoshop Raw, PNG, or PBM. From the Camera Raw dialog box in Photoshop, you can save the processed files in Digital Negative (DNG), JPEG, TIFF, or Photoshop (PSD) formats. Although Photoshop Camera Raw software can open and edit a camera raw image file, it cannot save an image in a camera raw format.

As new versions of Camera Raw become available, you can update this software by installing a new version of the plug-in. You can check for updates to Adobe software by choosing Help > Updates.

Different camera models save camera raw images in many different formats, and the data must be interpreted differently for these formats. Camera Raw includes support for many camera models, and it can interpret many camera raw formats.

About the Digital Negative (DNG) format

The Digital Negative (DNG) format is a non-proprietary, publicly documented, and widely supported format for storing raw camera data. Hardware and software developers use DNG because it results in a flexible workflow for processing and archiving camera raw data. You may also use DNG as an intermediate format for storing images that were originally captured using a proprietary camera raw format.

Because DNG metadata is publicly documented, software readers such as Camera Raw do not need camera-specific knowledge to decode and process files created by a camera that supports DNG. If support for a proprietary format is discontinued, users may not be able to access images stored in that format, and the images may be lost forever. Because DNG is publicly documented, it is far more likely that raw images stored as DNG files will be readable by software in the distant future, making DNG a safer choice for archival storage.

Metadata for adjustments made to images stored as DNG files can be embedded in the DNG file itself instead of in a sidecar XMP file or in the Camera Raw database.

You can convert camera raw files to the DNG format by using the Adobe DNG Converter or the Camera Raw dialog box. For more information on the DNG format and DNG Converter, see www.adobe.com/go/learn_ps_dng.

Processing images with Camera Raw

1. Copy camera raw files to your hard disk, organize them, and (optionally) convert them to DNG.

Before you do any work on the images that your camera raw files represent, transfer them from the camera's memory card, organize them, give them useful names, and otherwise prepare them for use. Use the Get Photos From Camera command in Adobe Bridge to accomplish these tasks automatically.

2. Open the image files in Camera Raw.

You can open camera raw files in Camera Raw from Adobe Bridge, After Effects, or Photoshop. You can also open JPEG and TIFF files in Camera Raw from Adobe Bridge. (See "Open images in Camera Raw" on page 85.)

To see a video tutorial on importing raw images from a digital camera into Adobe Bridge using Adobe Photo Downloader, go to the Adobe website at www.adobe.com/go/vid0005.

3. Adjust color.

Color adjustments include white balance, tone, and saturation. You can make most adjustments on the Basic tab, and then use controls on the other tabs to fine-tune the results. If you want Camera Raw to analyze your image and apply approximate tonal adjustments, click Auto on the Basic tab.

To apply the settings used for the previous image, or to apply the default settings for the camera model, camera, or ISO settings, choose the appropriate command from the Camera Raw Settings menu . (See "Apply saved Camera Raw settings" on page 101.)

To see a video tutorial on making nondestructive color adjustments to photos in Camera Raw, go to the Adobe website at www.adobe.com/go/vid0006.

To see a video tutorial on adjusting multiple images with Adobe Bridge and Camera Raw, go to the Adobe website at www.adobe.com/go/vid0007.

4. Make other adjustments and image corrections.

Use other tools and controls in the Camera Raw dialog box to perform such tasks as sharpening the image, reducing noise, correcting for lens defects, and retouching.

5. (Optional) Save image settings as a preset or as default image settings.

To apply the same adjustments to other images later, save the settings as a preset. To save the adjustments as the defaults to be applied to all images from a specific camera model, a specific camera, or a specific ISO setting, save the image settings as the new Camera Raw defaults. (See "Save, reset, and load Camera Raw settings" on page 99.)

6. Set workflow options for Photoshop.

Set options to specify how images are saved from Camera Raw and how Photoshop should open them. You can access the Workflow Options settings by clicking the link beneath the image preview in the Camera Raw dialog box.

7. Save the image, or open it in Photoshop or After Effects.

When you finish adjusting the image in Camera Raw, you can apply the adjustments to the camera raw file, open the adjusted image in Photoshop or After Effects, save the adjusted image to another format, or cancel and discard adjustments. If you open the Camera Raw dialog box from After Effects, the Save Image and Done buttons are unavailable.

Save Image Applies the Camera Raw settings to the images and saves copies of them in JPEG, PSD, TIFF, or DNG format. Press Alt (Windows) or Option (Mac OS) to suppress the Camera Raw Save Options dialog box and save the files using the last set of save options. (See “Save a camera raw image in another format” on page 86.)

Open Image or OK Opens copies of the camera raw image files (with the Camera Raw settings applied) in Photoshop or After Effects. The original camera raw image file remains unaltered. Press Shift while clicking Open Image to open the raw file in Photoshop as a Smart Object. At any time, you can double-click the Smart Object layer that contains the raw file to adjust the Camera Raw settings.

Done Closes the Camera Raw dialog box and stores file settings either in the camera raw database file, in the sidecar XMP file, or in the DNG file.

Cancel Cancels the adjustments specified in the Camera Raw dialog box.

Camera Raw dialog box overview

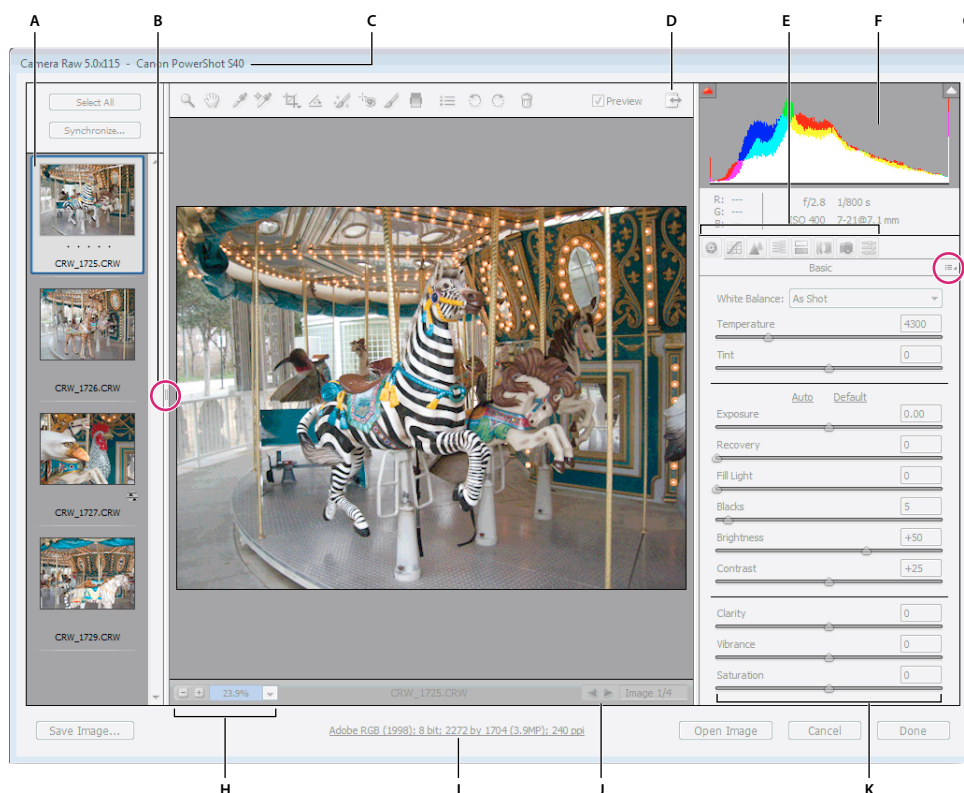

Camera Raw dialog box

A. Filmstrip B. Toggle Filmstrip C. Camera name or file format D. Toggle full-screen mode E. Image adjustment tabs F. Histogram G. Camera Raw Settings menu H. Zoom levels I. Click to display workflow options J. Navigation arrows K. Adjustment sliders

Note: Some controls, such as the Workflow Options link, that are available when you open the Camera Raw dialog box from Adobe Bridge or Photoshop are not available when you open the Camera Raw dialog box from After Effects.

Camera Raw Settings menu

To open the Camera Raw Settings menu, click the button  in the upper-right corner of any of the image adjustment tabs. Several of the commands in this menu are also available from the Edit > Develop Settings menu in Adobe Bridge.

Camera Raw view controls

Zoom tool  Sets the preview zoom to the next higher preset value when you click the preview image. Alt-click (Windows) or Option-click (Mac OS) to use the next lower zoom value. Drag the Zoom tool in the preview image to zoom in on a selected area. To return to 100%, double-click the Zoom tool.

Hand tool  Moves the image in the preview window if the preview image is set at a zoom level higher than 100%. Hold down the spacebar to temporarily activate the Hand tool while using another tool. Double-click the Hand tool to fit the preview image to the window.

Select Zoom Level Choose a magnification setting from the menu or click the Select Zoom Level buttons.

Preview Displays a preview of the image adjustments made in the current tab, combined with the settings in the other tabs. Deselect to show the image with the original settings of the current tab combined with the settings in the other tabs.

RGB Shows the red, green, and blue values of the pixel under the pointer in the preview image.

Shadows and Highlights Displays shadow and highlight clipping using the buttons at the top of the Histogram. Clipped shadows appear in blue, and clipped highlights appear in red. Highlight clipping is shown if any one of the three RGB channels is clipped (fully saturated with no detail). Shadow clipping is shown if all three RGB channels are clipped (black with no detail).

Image adjustment tabs

Basic  Adjust white balance, color saturation, and tonality.

Tone Curve  Fine-tune tonality using a Parametric curve and a Point curve.

Detail  Sharpen images or reduce noise.

HSL / Grayscale  Fine-tune colors using Hue, Saturation, and Luminance adjustments.

Split Toning  Color monochrome images or create special effects with color images.

Lens Corrections  Compensate for chromatic aberration and vignetting caused by the camera lens.

Camera Calibration  Correct a color cast in the shadows and adjust non-neutral colors to compensate for the difference between the behavior of your camera and the Camera Raw profile for your camera model.

Presets  Save and apply sets of image adjustment settings as presets.

Work with the Camera Raw cache in Adobe Bridge

When you view camera raw files in Adobe Bridge, the thumbnails and previews use either the default settings or your adjusted settings. The Adobe Bridge cache stores data for the file thumbnails, metadata, and file information. Caching this data shortens the loading time when you return to a previously viewed folder in Adobe Bridge. The Camera Raw cache speeds the opening of images in Camera Raw and rebuilds of previews in Adobe Bridge when image settings change in Camera Raw.

Because caches can become very large, you may want to purge the Camera Raw cache or limit its size. You can also purge and regenerate the cache if you suspect that it is corrupted or old.

Note: The Camera Raw cache holds data for about 200 images for each gigabyte of disk storage allocated to it. By default, the Camera Raw cache is set to a maximum size of 1 GB. You can increase its limit in the Camera Raw preferences.

- 1 In Adobe Bridge, choose Edit > Camera Raw Preferences (Windows) or Bridge > Camera Raw Preferences (Mac OS). Or, with the Camera Raw dialog box open, click the Open Preferences Dialog button .
- 2 Do any of the following:
 - To change the cache size, enter a Maximum Size value.
 - To purge the camera raw cache, click the Purge Cache button.
 - To change the location of the camera raw cache, click Select Location.

Navigating, opening, and saving images



Process, compare, and rate multiple images in Camera Raw

The most convenient way to work with multiple camera raw images is to use the Filmstrip view in Camera Raw. Filmstrip view opens by default when you open multiple images in Camera Raw from Adobe Bridge.

Note: The Filmstrip view is not available when importing multiple images into After Effects.

Images can have three states in Filmstrip view: deselected, selected (but not active), and active (also selected). In general, adjustments are applied to all selected images.

You can also synchronize settings to apply settings from the active image to all selected images. You can quickly apply a set of adjustments to an entire set of images—such as all shots taken under the same conditions—and then fine-tune the individual shots later, after you've determined which you'll use for your final output.

- To select an image, click its thumbnail. To select a range of images, Shift-click two thumbnails. To add an image to a selection, Ctrl-click (Windows) or Command-click (Mac OS) its thumbnail.
- To change which image is active without changing which images are selected, click a navigation arrow  at the bottom of the preview pane.
- To apply settings from the active image to all selected images, click the Synchronize button at the top of the Filmstrip pane and choose which settings to synchronize.
- To apply a star rating, click a rating under the image thumbnail.
- To mark selected images for deletion, click Mark For Deletion .

A red cross appears in the thumbnail of an image marked for deletion. The file is sent to the Recycle Bin (Windows) or Trash (Mac OS) when you close the Camera Raw dialog box. (If you decide to keep an image that you marked for deletion, select it in the Thumbnail pane and click Mark For Deletion again, before you close the Camera Raw dialog box.)

Automating image processing with Camera Raw

You can create an action to automate the processing of image files with Camera Raw. You can automate the editing process, and the process of saving the files in formats such as PSD, DNG, JPEG, Large Document Format (PSB), TIFF, and PDF. In Photoshop, you can also use the Batch command, the Image Processor, or the Create Droplet command to process one or more image files. The Image Processor is especially useful for saving image files in different file formats during the same processing session.

Here are some tips for automating the processing of camera raw image files:

- When you record an action, first select Image Settings from the Camera Raw Settings menu  in the Camera Raw dialog box. In this way, the settings particular to each image (from the Camera Raw database or sidecar XMP files) are used to play back the action.
- If you plan to use the action with the Batch command, you may want to use the Save As command and choose the file format when saving the camera raw image.
- When you use an action to open a camera raw file, the Camera Raw dialog box reflects the settings that were in effect when the action was recorded. You may want to create different actions for opening camera raw image files with different settings.
- When using the Batch command, select Override Action “Open” Commands. Any Open commands in the action will then operate on the batched files rather than the files specified by name in the action. Deselect Override Action “Open” Commands only if you want the action to operate on open files or if the action uses the Open command to retrieve needed information.
- When using the Batch command, select Suppress File Open Options Dialogs to prevent the display of the Camera Raw dialog box as each camera raw image is processed.
- When using the Batch command, select Override Action “Save As” Commands if you want to use the Save As instructions from the Batch command instead of the Save As instructions in the action. If you select this option, the action must contain a Save As command, because the Batch command does not automatically save the source files. Deselect Override Action “Save As” Commands to save the files processed by the Batch command in the location specified in the Batch dialog box.
- When creating a droplet, select Suppress File Open Options Dialogs in the Play area of the Create Droplet dialog box. This prevents the display of the Camera Raw dialog box as each camera raw image is processed.

Open images in Camera Raw

- To process raw images in Camera Raw, select one or more camera raw files in Adobe Bridge, and then choose File > Open In Camera Raw or press Ctrl+R (Windows) or Command+R (Mac OS). When you finish making adjustments in the Camera Raw dialog box, click Done to accept changes and close the dialog box. You can also click Open Image to open a copy of the adjusted image in Photoshop.
- To process JPEG or TIFF images in Camera Raw, select one or more JPEG or TIFF files in Adobe Bridge, and then choose File > Open In Camera Raw or press Ctrl+R (Windows) or Command+R (Mac OS). When you finish making adjustments in the Camera Raw dialog box, click Done to accept changes and close the dialog box. You can specify whether JPEG or TIFF images with Camera Raw settings are automatically opened in Camera Raw in the JPEG and TIFF Handling section of the Camera Raw preferences.
- To import camera raw images in Photoshop, select one or more camera raw files in Adobe Bridge, and then choose File > Open With > Adobe Photoshop CS4. (You can also choose the File > Open command in Photoshop, and browse to select camera raw files.) When you finish making adjustments in the Camera Raw dialog box, click Open Image to accept changes and open a copy of the adjusted image in Photoshop. Press Shift while clicking Open Image to open the image as a Smart Object in Photoshop. At any time, you can double-click the Smart Object layer that contains the raw file to adjust the Camera Raw settings.

 *Shift-double-click a thumbnail in Adobe Bridge to open a camera raw image in Photoshop without opening the Camera Raw dialog box. Hold down Shift while choosing File > Open to open multiple selected images.*

- To import camera raw images in After Effects using Adobe Bridge, select one or more camera raw files in Adobe Bridge, and then choose File > Open With > Adobe After Effects CS4. (You can also choose a File > Import command in After Effects and browse to select camera raw files.) When you finish making adjustments in the Camera Raw dialog box, click OK to accept changes.

- To import TIFF and JPEG files into After Effects using Camera Raw, select the File > Import command in After Effects, and then select All Files from the Enable menu (Mac OS) or Files Of Type menu (Windows) in the After Effects Import File dialog box. Select the file to import, select Camera Raw from the Format menu, and click Open.
- Placing image stacks from Adobe Bridge into After Effects imports them as an image sequence. Select the stack and then choose File > Place > In After Effects. Camera Raw settings applied to the first camera raw file upon import are applied to the remaining files in the sequence unless an XMP sidecar file is present for any subsequent file in the sequence. In that case, the settings in the XMP file or in the DNG file are applied to that specific frame in the sequence. All other frames use the settings that the first file in the sequence specifies.

Note: After Effects must be open for the Place > In After Effects command to be available in Adobe Bridge.

Save a camera raw image in another format

You can save camera raw files from the Camera Raw dialog box in PSD, TIFF, JPEG, or DNG formats.

When you use the Save command in the Camera Raw dialog box, files are placed in a queue to be processed and saved. This is useful if you are processing several files in the Camera Raw dialog box and saving them in the same format.

- 1 In the Camera Raw dialog box, click the Save Image button in the lower-left corner of the dialog box.

 *Alt-click (Windows) or Option-click (Mac OS) Save to suppress the Camera Raw Save Options dialog box when saving a file.*

- 2 In the Save Options dialog box, specify the following options:

Destination Specifies where to save the file. If necessary, click the Select Folder button and navigate to the location.

File Naming Specifies the filename using a naming convention that includes elements such as date and camera serial number. Using informative filenames based on a naming convention helps you keep image files organized.

- 3 Choose a file format from the Format menu.

- 4 Click Save.

Format options

Digital Negative Saves a copy of the camera raw file in the DNG file format.

- **Compressed (lossless)** Uses lossless compression, meaning that no information is lost while reducing the file size.
- **Convert To Linear Image** Stores the image data in an interpolated (demosaiced) format. The resulting interpolated image can be interpreted by other software even if that software does not have a profile for the digital camera that captured the image.
- **Embed Original Raw File** Stores all of the original camera raw image data in the DNG file.
- **JPEG Preview** Embeds a JPEG preview in the DNG file. If you decide to embed a JPEG preview, you can choose the preview size. If you embed JPEG previews, other applications can view the contents of the DNG file without parsing the camera raw data.

JPEG Saves copies of the camera raw files in JPEG (Joint Photographic Experts Group) format. To specify the amount of compression, enter a value from 0 to 12 or choose from the menu. Entering a higher value, or choosing High or Maximum, applies less compression and increases file size and image quality. JPEG format is commonly used to display photographs and other continuous-tone images in web photo galleries, slide shows, presentations, and other online services.

TIFF Saves copies of the camera raw files as TIFF (Tagged-Image File Format) files. Specify whether to apply no compression, or LZW or ZIP file compression. TIFF is a flexible bitmap image format supported by virtually all paint,

image-editing, and page-layout applications. TIFF provides greater compression and compatibility with other applications than does PSD format.

Photoshop Saves copies of the camera raw files in the PSD file format. You can specify whether to preserve cropped pixel data in the PSD file.

Making color and tonal adjustments in Camera Raw

Using histogram and RGB levels in Camera Raw

A *histogram* is a representation of the number of pixels at each luminance value in an image. A histogram that has nonzero values for each luminance value indicates an image that takes advantage of the full tonal scale. A histogram that doesn't use the full tonal range corresponds to a dull image that lacks contrast. A histogram with a spike at the left side indicates shadow clipping; a histogram with a spike on the right side indicates highlight clipping.

 Select *Shadows* or *Highlights* to see, in the preview image, which pixels are being clipped. For more information, see [“Preview highlight and shadow clipping in Camera Raw”](#) on page 87.

One common task for adjusting an image is to spread out the pixel values more evenly from left to right on the histogram, instead of having them bunched up at one end or the other.

A histogram is made up of three layers of color that represent the red, green, and blue color channels. White appears when all three channels overlap; yellow, magenta, and cyan appear when two of the RGB channels overlap (yellow equals the red + green channels, magenta equals the red + blue channels, and cyan equals the green + blue channels).

The histogram changes automatically as you adjust the settings in the Camera Raw dialog box.

The RGB values of the pixel under the pointer (in the preview image) appear below the histogram.

Note: You can also use the *Color Sampler* tool  to place up to nine color samplers in the preview image. The RGB values appear above the preview image. To remove a color sampler, *Alt-click* (Windows) or *Option-click* (Mac OS) it. To clear the color samplers, click *Clear Samplers*.

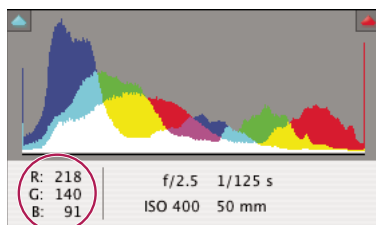

The Camera Raw dialog box displays the RGB values of the pixel under the pointer.

Preview highlight and shadow clipping in Camera Raw

Clipping occurs when the color values of a pixel are higher than the highest value or lower than the lowest value that can be represented in the image. Overbright values are clipped to output white, and overdark values are clipped to output black. The result is a loss of image detail.

- To see which pixels are being clipped with the rest of the preview image, select *Shadows* or *Highlights* options at the top of the histogram. Or press *U* to see shadow clipping, *O* to see highlight clipping.
- To see only the pixels that are being clipped, press *Alt* (Windows) or *Option* (Mac OS) while dragging the *Exposure*, *Recovery*, or *Blacks* sliders.

For the Exposure and Recovery sliders, the image turns black, and clipped areas appear white. For the Blacks slider, the image turns white and clipped areas appear black. Colored areas indicate clipping in one color channel (red, green, blue) or two color channels (cyan, magenta, yellow).

Note: In some cases, clipping occurs because the color space that you are working in has a gamut that is too small. If your colors are being clipped, consider working in a color space with a large gamut, such as ProPhoto RGB.

White balance controls in Camera Raw

In simple terms, adjusting the white balance is a matter of identifying what objects in the image should be neutral-colored (white or gray) and then adjusting the colors in the image to make those objects neutral-colored. A white or gray object in a scene takes on the color cast by the ambient light or flash used to shoot the picture. When you use the White Balance tool  to specify an object that should be white or gray, Camera Raw can determine the color of the light in which the scene was shot and then adjust for scene lighting automatically.

Color temperature (in Kelvins) is used as a measure of scene lighting because natural and incandescent light sources give off light in a predictable distribution according to their temperature.

A digital camera records the white balance at the time of exposure as a metadata entry. The Camera Raw plug-in reads this value and makes it the initial setting when you open the file in the Camera Raw dialog box. This setting usually yields the correct color temperature, or nearly so. You can adjust the white balance if it is not right.

Note: Not all color casts are a result of incorrect white balance. Use the DNG Profile Editor to correct a color cast that remains after the white balance is adjusted. See “Adjust color rendering for your camera in Camera Raw” on page 92.

The Basic tab in the Camera Raw dialog box has three controls for correcting a color cast in an image:

White Balance Camera Raw applies the white balance setting and changes the Temperature and Tint properties in the Basic tab accordingly. Use these controls to fine-tune the color balance.

- **As Shot** Uses the camera’s white balance settings, if they are available.
- **Auto** Calculates the white balance based on the image data.

Camera raw and DNG files also have the following white balance settings: Daylight, Cloudy, Shade, Tungsten, Fluorescent, and Flash.

Note: If Camera Raw doesn’t recognize the white balance setting of a camera, choosing As Shot is the same as choosing Auto.

Temperature Sets the white balance to a custom color temperature. Decrease Temperature to correct a photo taken with a lower color temperature of light; the Camera Raw plug-in makes the image colors bluer to compensate for the lower color temperature (yellowish) of the ambient light. Conversely, increase Temperature to correct a photo taken with a higher color temperature of light; the image colors become warmer (yellowish) to compensate for the higher color temperature (bluish) of the ambient light.

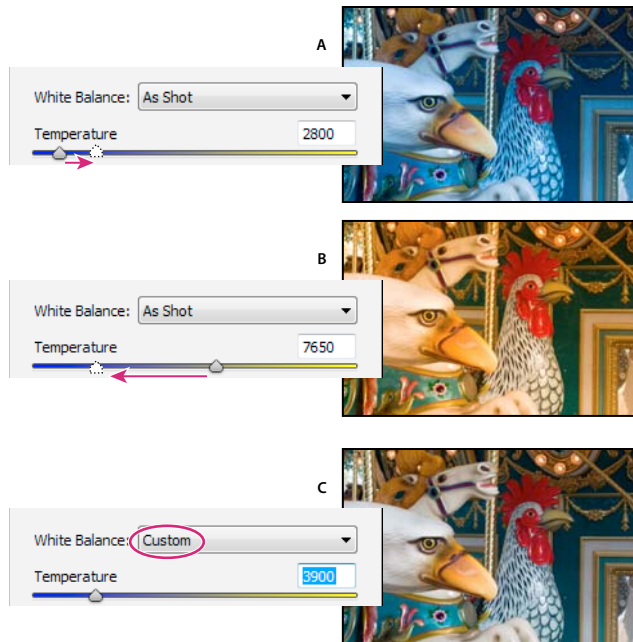

Note: The range and units for the Temperature and Tint controls are different when you are adjusting a non-camera raw image, such as a TIFF or JPEG image. For example, Camera Raw provides a true-temperature adjustment slider for raw files from 2,000 Kelvin to 50,000 Kelvin. For JPEG or TIFF files, Camera Raw attempts to approximate a different color temperature or white balance, but because the original value was already used to alter the pixel data in the file, Camera Raw does not provide the true Kelvin temperature scale. In these instances, an approximate scale of -100 to 100 is used in place of the temperature scale.



Correcting the white balance

A. Moving the Temperature slider to the right corrects a photo taken with a higher color temperature of light B. Moving the Temperature slider to the left corrects a photo taken with a lower color temperature of light C. Photo after color temperature adjustment

Tint Sets the white balance to compensate for a green or magenta tint. Decrease Tint to add green to the image; increase Tint to add magenta.

 *To adjust the white balance quickly, select the White Balance tool , and then click an area in the preview image that should be a neutral gray or white. The Temperature and Tint properties adjust to make the selected color exactly neutral (if possible). If you're clicking whites, choose a highlight area that contains significant white detail rather than a specular highlight. You can double-click the White Balance tool to reset White Balance to As Shot.*

Adjust tone in Camera Raw

You adjust the image tonal scale using the tone controls in the Basic tab.

When you click Auto at the top of the tone controls section of the Basic tab, Camera Raw analyzes the camera raw image and makes automatic adjustments to the tone controls (Exposure, Recovery, Fill Light, Blacks, Brightness, and Contrast).

You can also apply automatic settings separately for individual tone controls. To apply an automatic adjustment to an individual tone control, such as Exposure or Recovery, press Shift and double-click the slider. To return an individual tone control to its original value, double-click its slider.

When you adjust tone automatically, Camera Raw ignores any adjustments previously made in other tabs (such as fine-tuning of tone in the Tone Curves tab). For this reason, you should usually apply automatic tone adjustments first—if at all—to get an initial approximation of the best settings for your image. If you are careful during shooting and have deliberately shot with different exposures, you probably don't want to undo that work by applying automatic tone adjustments. On the other hand, you can always try clicking Auto and then undo the adjustments if you don't like them.

Previews in Adobe Bridge use the default image settings. If you want the default image settings to include automatic tone adjustments, select Apply Auto Tone Adjustments in the Default Image Settings section of the Camera Raw preferences.

Note: If you are comparing images based on their previews in Adobe Bridge, you may want to leave the Apply Auto Tone Adjustments preference deselected, which is the default. Otherwise, you'll be comparing images that have already been adjusted.

As you make adjustments, keep an eye on the end points of the histogram, or use the shadow and highlight clipping previews.

 While moving the Exposure, Recovery, or Blacks slider, hold down Alt (Windows) or Option (Mac OS) to preview where highlights or shadows are clipped. Move the slider until clipping begins, and then reverse the adjustment slightly. (For more information, see “Preview highlight and shadow clipping in Camera Raw” on page 87.)

- To manually adjust a tone control, drag the slider, type a number in the box, or select the value in the box and press the Up or Down Arrow key.
- To reset a value to its default, double-click the slider control.

Exposure Adjusts the overall image brightness, with a greater effect in the highlights. Decrease Exposure to darken the image; increase Exposure to brighten the image. The values are in increments equivalent to f-stops. An adjustment of +1.50 is like widening the aperture 1-1/2 stops. Similarly, an adjustment of -1.50 is like reducing the aperture 1-1/2 stops. (Use Recovery to bring highlight values down.)

Recovery Attempts to recover details from highlights. Camera Raw can reconstruct some details from areas in which one or two color channels are clipped to white.

Fill Light Attempts to recover details from shadows, without brightening blacks. Camera Raw can reconstruct some details from areas in which one or two color channels are clipped to black. Using Fill Light is like using the shadows portion of the Photoshop Shadow/Highlight filter or the After Effects Shadow/Highlight effect.

Blacks Specifies which input levels are mapped to black in the final image. Increasing Blacks expands the areas that are mapped to black. This sometimes creates the impression of increased contrast in the image. The greatest change is in the shadows, with much less change in the midtones and highlights. Using the Blacks slider is like using the black point slider for input levels when using the Photoshop Levels command or the After Effects Levels effect.

Brightness Adjusts the brightness or darkness of the image, much as the Exposure property does. However, instead of clipping the image in the highlights or shadows, Brightness compresses the highlights and expands the shadows when you move the slider to the right. Often, the best way to use this control is to set the overall tonal scale by first setting Exposure, Recovery, and Blacks; then set Brightness. Large Brightness adjustments can affect shadow or highlight clipping, so you may want to readjust the Exposure, Recovery, or Blacks property after adjusting Brightness.

Contrast Increases or decreases image contrast, mainly affecting midtones. When you increase contrast, the middle-to-dark image areas become darker, and the middle-to-light image areas become lighter. Generally, you use the Contrast property to adjust the contrast of the midtones after setting the Exposure, Blacks, and Brightness values.

Fine-tune tone curves in Camera Raw

Use the controls in the Tone Curve tab to fine-tune images after you've made tone adjustments in the Basic tab. The tone curves represent changes made to the tonal scale of an image. The horizontal axis represents the original tone values of the image (input values), with black on the left and progressively lighter values toward the right. The vertical axis represents the changed tone values (output values), with black on the bottom and progressing to white at the top.

If a point on the curve moves up, the output is a lighter tone; if it moves down, the output is a darker tone. A straight, 45-degree line indicates no changes to the tone response curve: the original input values exactly match the output values.

Use the tone curve in the nested Parametric tab to adjust the values in specific tonal ranges in the image. The areas of the curve affected by the region properties (Highlights, Lights, Darks, or Shadows) depend on where you set the split controls at the bottom of the graph. The middle region properties (Darks and Lights) mostly affect the middle region of the curve. The Highlight and Shadows properties mostly affect the ends of the tonal range.

❖ To adjust tone curves, do any of the following:

- Drag the Highlights, Lights, Darks, or Shadows slider in the nested Parametric tab. You can expand or contract the curve regions that the sliders affect by dragging the region divider controls along the horizontal axis of the graph.
- Drag a point on the curve in the nested Point tab. As you drag the point, the Input and Output tonal values are displayed beneath the tone curve.
- Choose an option from the Curve menu in the nested Point tab. The setting you choose is reflected in the Point tab, but not in the settings in the Parametric tab. Medium Contrast is the default setting.

Clarity, Vibrance, and Saturation controls in Camera Raw

You can change the color saturation (vividness or color purity) of all colors by adjusting the Clarity, Vibrance, and Saturation controls on the Basic tab. (To adjust saturation for a specific range of colors, use the controls on the HSL / Grayscale tab.)

Clarity Adds depth to an image by increasing local contrast, with greatest effect on the midtones. This setting is like a large-radius unsharp mask. When using this setting, it is best to zoom in to 100% or greater. To maximize the effect, increase the setting until you see halos near the edge details of the image and then reduce the setting slightly.

Vibrance Adjusts the saturation so that clipping is minimized as colors approach full saturation. This setting changes the saturation of all lower-saturated colors with less effect on the higher-saturated colors. Vibrance also prevents skin tones from becoming oversaturated.

Saturation Adjusts the saturation of all image colors equally from -100 (monochrome) to +100 (double the saturation).

HSL / Grayscale controls in Camera Raw

You can use the controls in the HSL / Grayscale tab to adjust individual color ranges. For example, if a red object looks too vivid and distracting, you can decrease the Reds values in the nested Saturation tab.

The following nested tabs contain controls for adjusting a color component for a specific color range:

Hue Changes the color. For example, you can change a blue sky (and all other blue objects) from cyan to purple.

Saturation Changes the color vividness or purity of the color. For example, you can change a blue sky from gray to highly saturated blue.

Luminance Changes the brightness of the color range.

If you select Convert To Grayscale, you see only one nested tab:

Grayscale Mix Use controls in this tab to specify the contribution of each color range to the grayscale version of the image.

Tone a grayscale image in Camera Raw

Use the controls in the Split Toning tab to color a grayscale image. You can add one color throughout the tonal range, such as a sepia appearance, or create a split tone result, in which a different color is applied to the shadows and the highlights. The extreme shadows and highlights remain black and white.

You can also apply special treatments, such as a cross-processed look, to a color image.

- 1 Select a grayscale image. (It can be an image that you converted to grayscale by selecting Convert To Grayscale in the HSL / Grayscale tab.)
- 2 In the Split Toning tab, adjust the Hue and Saturation properties for the highlights and shadows. Hue sets the color of the tone; Saturation sets the magnitude of the result.
- 3 Adjust the Balance control to balance the influence between the Highlight and Shadow controls. Positive values increase the influence of the Shadow controls; negative values increase the influence of the Highlight controls.

Adjust color rendering for your camera in Camera Raw

For each camera model it supports, Camera Raw uses color profiles to process raw images. The profiles are produced by photographing color targets under two standardized lighting conditions.

In some cases, colors rendered by the Camera Raw plug-in may not appear as expected. To improve color rendering, use the DNG Profile Editor to edit the color profiles for your camera.

The DNG Profile Editor and documentation for it are available as a free download from the Adobe website at www.adobe.com/go/learn_ps_dng.

Compensate for chromatic aberration in Camera Raw

Chromatic aberration is a common defect caused by the failure of the lens to focus different frequencies (colors) to the same spot. In one type of chromatic aberration, the image from each color of light is in focus, but each image is a slightly different size. This type of aberration is seen as a complementary color fringing in areas away from the center of the image. For example, a red fringe may appear on the side of an object toward the center of the image, and cyan fringe on the side of the object away from the center of the image.



Original image (top), and after fixing chromatic aberration (bottom)

Another type of chromatic artifact affects the edges of specular highlights, such as those found when light is reflected off of the surface of rippled water or edges of polished metal. This situation usually results in a purple fringe around each specular highlight. Similar-colored fringing can occur along edges between dark objects and very bright objects.

- 1 Zoom into an area near the corner of the preview image. For the best results, the area should contain very dark or black detail against a very light or white background. Look for the color fringing.
- 2 In the Lens Corrections tab, adjust any of these controls:

Fix Red/Cyan Fringe Adjusts the size of the red channel relative to the green channel. This compensates for red/cyan color fringing.

Fix Blue/Yellow Fringe Adjusts the size of the blue channel relative to the green channel. This compensates for blue/yellow color fringing.

Defringe Desaturates colored fringing around specular highlights. Choose All Edges to correct color fringing for all edges, including any sharp change in color values. If choosing All Edges results in thin gray lines near edges or other unwanted effects, choose Highlight Edges to correct color fringing only in edges of highlighting, where fringing is most likely to occur. Choose Off to turn off defringing.

Look at the preview image as you move each slider left or right. If you're adjusting red/cyan color fringing, hold down Alt (Windows) or Option (Mac OS) to hide the blue/yellow color fringing. Similarly, hold down Alt (Windows) or Option (Mac OS) while adjusting the blue/yellow color fringing to hide the red/cyan color fringing. The goal is to reduce the color fringing as much as possible.

Compensate for lens vignetting in Camera Raw

Vignetting is a lens defect that causes the edges, especially the corners, of an image to be darker than the center. Use controls in the Lens Vignetting section of the Lens Correction tab to compensate for vignetting.

- 1 Increase Amount to lighten the corners, or decrease Amount to darken them.
- 2 Decrease Midpoint to apply the adjustment to a larger area away from the corners, or increase Midpoint to restrict the adjustment to an area closer to the corners.

Apply a postcrop vignette in Camera Raw

To apply a vignette to a cropped image for artistic effect, use the Post Crop Vignetting feature.

- 1 Crop your image. See “[Crop selected images in Camera Raw](#)” on page 94.
- 2 In the Lens Corrections tab, enter an Amount or adjust the Amount slider, and then adjust the Post Crop Vignetting sliders:

Amount Positive values lighten the corners, negative values darken them.



Midpoint Higher values restrict the adjustment to the area closer to the corners, lower values apply the adjustment to a larger area away from the corners.

Roundness Positive values make the effect more circular, negative values make the effect more oval.

Feather Higher values increase the softening between the effect and its surrounding pixels, lower values reduce the softening between the effect and its surrounding pixels.

Modifying images with Camera Raw

Rotate images with Camera Raw

- Click the Rotate Image 90° Counter Clockwise button  (or press L).
- Click the Rotate Image 90° Clockwise button  (or press R).

Note: Using commands in the Edit menu, you can also rotate images in Adobe Bridge without opening the Camera Raw dialog box.

Straighten images in Camera Raw

- 1 In the Camera Raw dialog box, select the Straighten tool  (or press A).

- 2 Drag the Straighten tool in the preview image to establish what's horizontal or vertical.

Note: The Crop tool is active immediately after you use the Straighten tool.

Crop selected images in Camera Raw

- 1 In the Camera Raw dialog box, select the Crop tool  (or press C).

To constrain your initial crop area to a specific aspect ratio, hold the mouse button down as you select the Crop tool , and choose an option from the menu. To apply a constraint to a previously applied crop, Ctrl-click (Mac OS) or right-click (Windows) on the crop.

- 2 Drag in the preview image to draw the crop area box.
- 3 To move, scale, or rotate the crop area, drag the crop area or its handles.

When you are finished, the cropped area of the image remains visible, but is dimmed in the image preview.

Note: To cancel the crop operation, press Esc with the Crop tool active, or click and hold the Crop tool button and choose Clear Crop from the menu. To cancel the crop and close the Camera Raw dialog box without processing the camera raw image file, click the Cancel button or deselect the Crop tool and press Esc.

Remove red-eye in Camera Raw

- 1 Zoom the image in to at least 100%.
- 2 In the toolbar, select the Red Eye Removal tool  (or press E).
- 3 Drag a selection in the photo around the red eye.

Camera Raw sizes the selection to match the pupil. You can adjust the size of the selection by dragging its edges.

- 4 In the tool options under the Histogram, drag the Pupil Size slider to the right to increase the size of the area corrected.
- 5 Drag the Darken slider to the right to darken the pupil area within the selection and the iris area outside the selection.

Deselect Show Overlay to turn off the selection and check your correction.

Note: Move between multiple selected red eye areas by clicking the selection.

Retouch images in Camera Raw

The Spot Removal tool  lets you repair a selected area of an image with a sample from another area.

- 1 Select the Spot Removal tool  from the toolbar.
- 2 Select one of the following from the Type menu:

Heal Matches the texture, lighting, and shading of the sampled area to the selected area.

Clone Applies the sampled area of the image to the selected area.

- 3 (Optional) In the tool options under the Histogram, drag the Radius slider to specify the size of the area that the Spot Removal tool affects.
- 4 Move the Spot Removal tool into the photo and click the part of the photo to retouch. A red-and-white dashed circle appears over the selected area. The green-and-white dashed circle designates the sampled area of the photo used to clone or heal.

5 Do any of the following:



- To specify the sampled area, drag inside the green-and-white circle to move it to another area of the image.
- To specify the selected area being cloned or healed, drag inside the red-and-white circle.
- To adjust the size of the circles, move the pointer over the edge of either circle until it changes to a double-pointing arrow, and then drag to make both circles larger or smaller.
- To cancel the operation, press Backspace (Windows) or Delete (Mac OS).

Repeat this procedure for each area of the image that needs retouching. To remove all sample areas and start over, click the Clear All button in the tool options.

Adjust sharpening in Camera Raw

The sharpening controls on the Detail tab adjust edge definition in the image. Camera Raw provides four adjustments to help you fine-tune image sharpness.

Use the Apply Sharpening To preference in the Camera Raw preferences to specify whether sharpening is applied to all images or just to previews.

 To open preferences from within Camera Raw, click the Open Preferences Dialog button  in the toolbar. To open Camera Raw preferences from within Adobe Bridge, choose Edit > Camera Raw Preferences (Windows) or Adobe Bridge CS4 > Camera Raw Preferences (Mac OS). To open Camera Raw preferences from within Photoshop, choose Edit > Preferences > Camera Raw (Windows) or Photoshop > Preferences > Camera Raw (Mac OS).

1 Zoom the preview image to at least 100%.

2 In the Detail tab, adjust any of these controls:

Amount Adjusts edge definition. Increase the Amount value to increase sharpening. A value of zero (0) turns off sharpening. In general, set Amount to a lower value for cleaner images. The adjustment is a variation of Unsharp Mask, which locates pixels that differ from surrounding pixels based on the threshold you specify and increases the pixels' contrast by the amount you specify. When opening a camera raw image file, the Camera Raw plug-in calculates the threshold to use based on camera model, ISO, and exposure compensation.

Radius Adjusts the size of the details that sharpening is applied to. Photos with very fine details may need a lower setting. Photos with larger details may be able to use a larger radius. Using too large a radius generally results in unnatural-looking results.

Detail Adjusts how much high-frequency information is sharpened in the image and how much the sharpening process emphasizes edges. Lower settings primarily sharpen edges to remove blurring. Higher values are useful for making the textures in the image more pronounced.

Masking Controls an edge mask. With a setting of zero (0), everything in the image receives the same amount of sharpening. With a setting of 100, sharpening is mostly restricted to those areas near the strongest edges. Press Alt (Windows) or Option (Mac OS) while dragging this slider to see the areas to be sharpened (white) versus the areas masked out (black).

Reducing noise in Camera Raw

The Noise Reduction section of the Detail tab has controls for reducing *image noise*, the extraneous visible artifacts that degrade image quality. Image noise includes luminance (grayscale) noise, which makes an image look grainy, and chroma (color) noise, which is usually visible as colored artifacts in the image. Photos taken with high ISO speeds or less-sophisticated digital cameras can have noticeable noise.

The Luminance control reduces grayscale noise, and the Color control reduces chroma noise. Moving a slider to zero turns off noise reduction.



💡 *When making Luminance or Color Noise Reduction adjustments, first zoom in on the preview image to at least 100% to see the noise reduction previewed.*



Moving the Luminance slider to the right reduces grayscale noise (upper right), and moving the Color Noise Reduction slider to the right reduces chroma noise (lower right).

Making local adjustments in Camera Raw

About local adjustments

The controls in the image adjustment tabs of Camera Raw let you affect the color and tone of an entire photo. To make adjustments to a specific area of a photo, like dodging and burning in traditional photography, you can use the Adjustment Brush tool  and the Graduated Filter tool  in Camera Raw.

The Adjustment Brush tool lets you selectively apply Exposure, Brightness, Clarity, and other adjustments by “painting” them onto the photo.

The Graduated Filter tool lets you apply the same types of adjustments gradually across a region of a photo. You can make the region as wide or as narrow as you like.

You can apply both types of local adjustments to any photo, customizing and refining them to your liking.

Getting local adjustments “right” in Camera Raw may take some experimentation. The recommended workflow is to select a tool and specify its options, and then apply the adjustment to the photo. Then you can go back and edit that adjustment, or apply a new one. As with all other adjustments applied in Camera Raw, local adjustments are nondestructive. They are never permanently applied to the photo.

For a video tutorial on making local adjustments in Camera Raw, go to www.adobe.com/go/lrvid4008_ps.

Apply local adjustments with the Adjustment Brush tool

1 Select the Adjustment Brush tool  from the toolbar (or press K).

Camera Raw opens the Adjustment Brush tool options under the Histogram and sets the mask mode to New.

2 Choose the type of adjustment you want to make in the Adjustment Brush tool options by dragging the slider for any of the following effects:

Exposure Sets the overall image brightness, with a greater effect in the highlights. Drag the slider to the right to increase the exposure; drag the slider to the left to decrease the exposure.

Brightness Adjusts the image brightness, with a greater effect in the midtones. Drag the slider to the right to increase the brightness; drag the slider to the left to decrease the brightness.

Contrast Adjusts the image contrast, with a greater effect in the midtones. Drag the slider to the right to increase the contrast; drag the slider to the left to decrease the contrast.

Saturation Changes the vividness or purity of the color. Drag the slider to the right to increase the saturation; drag the slider to the left to decrease the saturation.

Clarity Adds depth to an image by increasing local contrast. Drag the slider to the right to increase the contrast; drag the slider to the left to decrease the contrast.

Sharpness Enhances edge definition to bring out details. Drag the slider to the right to sharpen details; drag the slider to the left to blur details.

Color Applies a tint to the selected area. Select the hue by clicking the color sample box to the right of the effect name.

 Click the Plus icons (+) or the Minus icons (-) to increase or decrease the effect by a preset amount. Click multiple times to select a stronger adjustment. Double-click the slider to reset the effect to zero.

3 Specify brush options:

Size Specifies the diameter of the brush tip, in pixels.

Feather Controls the hardness of the brush stroke.

Flow Controls the rate of application of the adjustment.

Density Controls the amount of transparency in the stroke.

Auto Mask Confines brush strokes to areas of similar color.

Show Mask Toggles visibility of the mask overlay in the image preview.

4 Move the Adjustment Brush tool over the image.

The cross hair indicates the application point. The solid circle indicates the brush size. The black-and-white dashed circle indicates the feather amount.

Note: If the Feather is set to 0, the black-and-white circle indicates the brush size. With very small feather amounts, the solid circle may not be visible.

5 Paint with the Adjustment Brush tool in the area of the image that you want to adjust.

When you release the mouse, a pin icon  appears at the application point. In the Adjustment Brush tool options, the mask mode changes to Add.

6 (Optional) Refine the adjustment by doing any of the following:

- Drag any of the effect sliders in the Adjustment Brush tool options to customize the effect in the image.
- Press V to hide or show the pin icon.
- To toggle visibility of the mask overlay, use the Show Mask option, press Y, or position the pointer over the pin icon.

 To customize the color of the mask overlay, click the color swatch next to the Show Mask option. Then, choose a new color from the Color Picker.

- To undo part of the adjustment, click Erase in the Adjustment Brush tool options and paint over the adjustment.

- Remove the adjustment completely by selecting the pin and pressing Delete.
 - Press Ctrl+Z (Windows) or Command+Z (Mac OS) to undo your last adjustment.
 - Click Clear All at the bottom of the tool options to remove all Adjustment Brush tool adjustments and set the mask mode to New.
- 7 (Optional) Click New to apply an additional Adjustment Brush tool adjustment, and refine it as desired using the techniques in step 6.

Note: When working with multiple Adjustment Brush adjustments, make sure you're in Add mode to switch between them. Click a pin icon to select that adjustment and refine it.

Apply local adjustments with the Graduated Filter tool

- 1 Select the Graduated Filter tool  from the toolbar (or press G).

Camera Raw opens the Graduated Filter tool options under the Histogram and sets the mask mode to New.

- 2 Choose the type of adjustment you want to make in the Graduated Filter tool options by dragging the slider for any of the following effects:

Exposure Sets the overall image brightness, with a greater effect in the highlights. Drag the slider to the right to increase the exposure; drag the slider to the left to decrease the exposure.

Brightness Adjusts the image brightness, with a greater effect in the midtones. Drag the slider to the right to increase the brightness; drag the slider to the left to decrease the brightness.

Contrast Adjusts the image contrast, with a greater effect in the midtones. Drag the slider to the right to increase the contrast; drag the slider to the left to decrease the contrast.

Saturation Changes the vividness or purity of the color. Drag the slider to the right to increase the saturation; drag the slider to the left to decrease the saturation.

Clarity Adds depth to an image by increasing local contrast. Drag the slider to the right to increase the contrast; drag the slider to the left to decrease the contrast.

Sharpness Enhances edge definition to bring out details. Drag the slider to the right to sharpen details; drag the slider to the left to blur details.

Color Applies a tint to the selected area. Select the hue by clicking the color sample box to the right of the effect name.

 Click the Plus icon (+) or the Minus icon (-) to increase or decrease the effect by a preset amount. Double-click the slider to reset the effect to zero.

- 3 Drag in the photo to apply a graduated filter across a region of the photo.

The green dot represents the start point at the beginning edge of the filter. The red dot represents the center of the ending edge of the filter. The black-and-white dotted line connecting the points represents the midline. The green-and-white and red-and-white dotted lines represent the beginning and end of the range of the effect.

The mask mode switches to Edit in the Graduated Filter tool options.

- 4 (Optional) Refine the filter by doing any of the following:

- Drag any of the effect sliders in the Graduated Filter tool options to customize the filter.
- Toggle visibility of the guide overlays by selecting the Show Overlay option (or press V).
- Drag the green or red dot to move the filter start or end point.
- Drag the black-and-white dotted line to move the midline of the filter.

- Position the pointer over the green-and-white or red-and-white dotted line, near the green or red dot, until a double-pointing arrow appears. Then, drag toward the edge of the photo to expand the range of the filter effect at that end of the spectrum. Drag toward the center of the photo to contract the range of the filter effect at that end of the spectrum.
 - Position the pointer over the green-and-white or red-and-white dotted line, away from the green or red dot, until a curved double-pointing arrow appears. Then, drag to rotate the effect.
 - Remove the filter by pressing Delete.
 - Press Ctrl+Z (Windows) or Command+Z (Mac OS) to undo your last adjustment.
 - Click Clear All at the bottom of the tool options to remove all Graduated Filter tool effects and set the mask mode to New.
- 5 (Optional) Click New to apply an additional Graduated Filter tool effect, and refine it as desired using the techniques in step 4.

Note: When working with multiple Graduated Filter effects, click an overlay to select that effect and refine it.

Camera Raw settings

Save, reset, and load Camera Raw settings

You can reuse the adjustments that you've made to an image. You can save all of the current Camera Raw image settings, or any subset of them, as a preset or as a new set of defaults. The default settings apply to a specific camera model, a specific camera serial number, or a specific ISO setting, depending on the settings in the Default Image Settings section of the Camera Raw preferences.

Presets appear by name in the Presets tab, in the Edit > Develop Settings menu in Adobe Bridge, in the context menu for camera raw images in Adobe Bridge, and in the Apply Presets submenu of the Camera Raw Settings menu in the Camera Raw dialog box. Presets are not listed in these locations if you don't save them to the Camera Raw settings folder. However, you can use the Load Settings command to browse for and apply settings saved elsewhere.



You can save and delete presets using the buttons at the bottom of the Presets tab.

- ❖ Click the Camera Raw Settings menu button  and choose a command from the menu:

Save Settings Saves the current settings as a preset. Choose which settings to save in the preset, and then name and save the preset.

Save New Camera Raw Defaults Saves the current settings as the new default settings for other images taken with the same camera, with the same camera model, or with the same ISO setting. Select the appropriate options in the Default Image Settings section of the Camera Raw preferences to specify whether to associate the defaults with a specific camera's serial number or with an ISO setting.

Reset Camera Raw Defaults Restores the original default settings for the current camera, camera model, or ISO setting.

Load Settings Opens the Load Raw Conversion Settings dialog box, in which you browse to the settings file, select it, and then click Load.

Specify where Camera Raw settings are stored

Choose a preference to specify where the settings are stored. The XMP files are useful if you plan to move or store the image files and want to retain the camera raw settings. You can use the Export Settings command to copy the settings in the Camera Raw database to sidecar XMP files or embed the settings in Digital Negative (DNG) files.

When a camera raw image file is processed with Camera Raw, the image settings are stored in one of two places: the Camera Raw database file or a sidecar XMP file. Settings for DNG files are typically stored in the DNG files themselves, as with TIFF and JPEG files.

Note: When you import a sequence of camera raw files in After Effects, the settings for the first file are applied to all files in the sequence that do not have their own XMP sidecar files. After Effects does not check the Camera Raw database.

You can set a preference to determine where settings are stored. When you reopen a camera raw image, all settings default to the values used when the file was last opened. Image attributes (target color space profile, bit depth, pixel size, and resolution) are not stored with the settings.

- 1 In Adobe Bridge, choose Edit > Camera Raw Preferences (Windows) or Bridge > Camera Raw Preferences (Mac OS). Or, with the Camera Raw dialog box open, click the Open Preferences Dialog button .

- 2 In the Camera Raw Preferences dialog box, choose one of the following from the Save Image Settings In menu:

Camera Raw Database Stores the settings in a Camera Raw database file in the folder Document and Settings/[user name]/Application Data/Adobe/CameraRaw (Windows) or Users/[user name]/Library/Preferences (Mac OS). This database is indexed by file content, so the image retains camera raw settings even if the camera raw image file is moved or renamed.

Sidecar “.xmp” Files Stores the settings in a separate file, in the same folder as the camera raw file, with the same base name and an .xmp extension. This option is useful for long-term archiving of raw files with their associated settings, and for the exchange of camera raw files with associated settings in multiuser workflows. These same sidecar XMP files can store IPTC (International Press Telecommunications Council) data or other metadata associated with a camera raw image file. If you open files from a read-only volume such as a CD or DVD, be sure to copy the files to your hard disk before opening them. The Camera Raw plug-in cannot write an XMP file to a read-only volume and writes the settings to the Camera Raw database file instead. You can view XMP files in Adobe Bridge by choosing View > Show Hidden Files.

Important: If you are using a revision control system to manage your files and are storing settings in sidecar XMP files, keep in mind that you must check your sidecar files in and out to change camera raw images; similarly, you must manage (e.g., rename, move, delete) XMP sidecar files together with their camera raw files. Adobe Bridge, Photoshop, After Effects, and Camera Raw take care of this file synchronization when you work with files locally.

 If you store the camera raw settings in the Camera Raw database and plan to move the files to a different location (CD, DVD, another computer, and so forth), you can use the Export Settings To XMP command to export the settings to sidecar XMP files.

- 3 If you want to store all adjustments to DNG files in the DNG files themselves, select Ignore Sidecar “.xmp” Files in the DNG File Handling section of the Camera Raw Preferences dialog box.

Copy and paste Camera Raw settings

In Adobe Bridge, you can copy and paste the Camera Raw settings from one image file to another.

- 1 In Adobe Bridge, select a file and choose Edit > Develop Settings > Copy Camera Raw Settings.
- 2 Select one or more files and choose Edit > Develop Settings > Paste Camera Raw Settings.

 You can also right-click (Windows) or Control-click (Mac OS) image files to copy and paste using the context menu.

- 3 In the Paste Camera Raw Settings dialog box, choose which settings to apply.

Apply saved Camera Raw settings

- 1 In Adobe Bridge or in the Camera Raw dialog box, select one or more files.
- 2 In Adobe Bridge, choose Edit > Develop Settings, or right-click a selected file. Or, in the Camera Raw dialog box, click the Camera Raw Settings menu .
- 3 Choose one of the following:

Image Settings Uses the settings from the selected camera raw image. This option is available only from the Camera Raw Settings menu in the Camera Raw dialog box.

Camera Raw Defaults Uses the saved default settings for a specific camera, camera model, or ISO setting.

Previous Conversion Uses the settings from the previous image of the same camera, camera model, or ISO setting.

A preset name Uses the settings (which can be a subset of all image settings) saved as a preset.

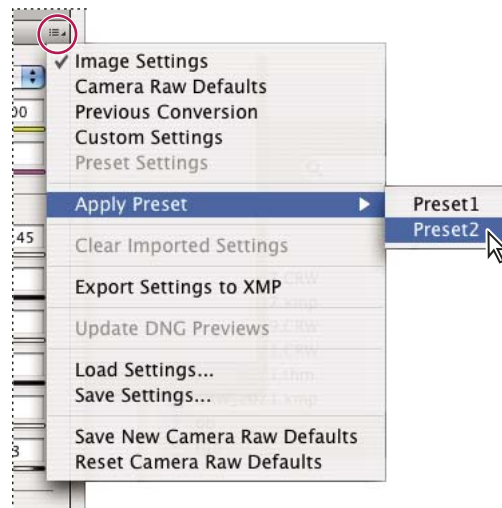

Applying a preset

Note: You can also apply presets from the Presets tab.

Export Camera Raw settings and DNG previews

If you store file settings in the Camera Raw database, you can use the Export Settings To XMP command to copy the settings to sidecar XMP files or embed them in DNG files. This is useful for preserving the image settings with your camera raw files when you move them.

You can also update the JPEG previews embedded in DNG files.

- 1 Open the files in the Camera Raw dialog box.
- 2 If you are exporting settings or previews for multiple files, select their thumbnails in the Filmstrip view.
- 3 In the Camera Raw Settings menu , choose Export Settings To XMP or Update DNG Previews.

The sidecar XMP files are created in the same folder as the camera raw image files. If you saved the camera raw image files in DNG format, the settings are embedded in the DNG files themselves.

Camera Raw Workflow options

Workflow options specify settings for all files output from Camera Raw, including the color bit depth, color space, and pixel dimensions. Workflow options determine how Photoshop opens these files, but do not affect how After Effects imports a camera raw file. Workflow settings do not affect the camera raw data itself.

You can see and change these Workflow settings by clicking the underlined text at the bottom of the Camera Raw dialog box.

Space Specifies the target color profile. Generally, set Space to the color profile you use for your Photoshop RGB working space. The source profile for camera raw image files is usually the camera-native color space. The profiles listed in the Space menu are built in to Camera Raw. To use a color space that's not listed in the Space menu, choose ProPhoto RGB, and then convert to the working space of your choice when the file opens in Photoshop.

Depth Specifies whether the file opens as an 8-bpc or 16-bpc image in Photoshop.

Size Specifies the pixel dimensions of the image when imported into Photoshop. The default pixel dimensions are those used to photograph the image. To resample the image, use the Size menu.

For square-pixel cameras, choosing a smaller-than-native size can speed processing when you are planning a smaller final image. Picking a larger size is like upsampling in Photoshop.

For non-square pixel cameras, the native size is the size that most closely preserves the total pixel count. Selecting a different size minimizes the resampling that Camera Raw needs to perform, resulting in slightly higher image quality. The best quality size is marked with an asterisk (*) in the Size menu.

Note: You can always change the pixel size of the image after it opens in Photoshop.

Resolution Specifies the resolution at which the image is printed. This setting does not affect the pixel dimensions. For example, a 2048 x 1536 pixel image, when printed at 72 dpi, is approximately 28-1/2 x 21-1/4 inches. When printed at 300 dpi, the same image is approximately 6-3/4 x 5-1/8 inches. You can also use the Image Size command to adjust resolution in Photoshop.

Open In Photoshop As Smart Objects Causes Camera Raw images to open in Photoshop as a Smart Object layer instead of a background layer when you click the Open button. To override this preference for selected images, press Shift when clicking Open.

Chapter 5: Color

Color can be described in several ways using a color model such as RGB or CMYK. As you work in your image, you specify colors using one of the color models. In Photoshop you choose the approach to color that's appropriate for your image and how it's being used.

About color

Understanding color

Knowing how colors are created and how they relate to each other lets you work more effectively in Photoshop. Instead of achieving an effect by accident, you'll produce consistent results thanks to an understanding of basic color theory.

Primary colors

Additive primaries are the three colors of light (red, green, and blue) that produce all the colors in the visible spectrum when added together in different combinations. Adding equal parts of red, blue, and green light produces white. The complete absence of red, blue, and green light results in black. Computer monitors are devices that use the additive primaries to create color.

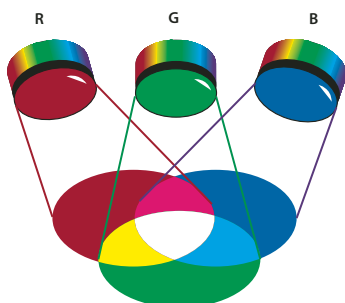

Additive colors (RGB)
R. Red **G.** Green **B.** Blue

Subtractive primaries are pigments, which create a spectrum of colors in different combinations. Unlike monitors, printers use subtractive primaries (cyan, magenta, yellow, and black pigments) to produce colors through subtractive mixing. The term “subtractive” is used because the primary colors are pure until you begin mixing them together, resulting in colors that are less pure versions of the primaries. For example, orange is created through the subtractive mixing of magenta and yellow together.

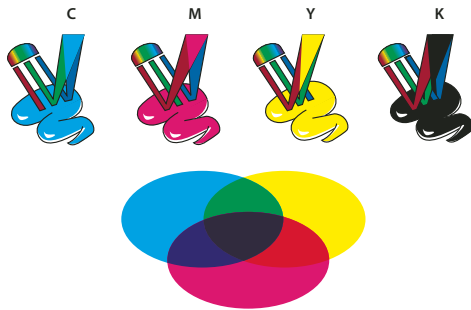

Subtractive colors (CMYK)
C. Cyan M. Magenta Y. Yellow K. Black

The color wheel

If you're new to adjusting color components, it helps to keep a standard color wheel diagram on hand when you work on color balance. You can use the color wheel to predict how a change in one color component affects other colors and also how changes translate between RGB and CMYK color models.

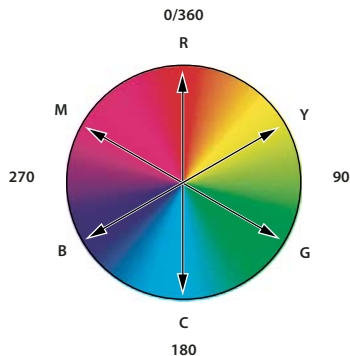

Color wheel
R. Red Y. Yellow G. Green C. Cyan B. Blue M. Magenta

For example, you can decrease the amount of any color in an image by increasing the amount of its opposite on the color wheel—and vice versa. Colors that lie opposite each other on the standard color wheel are known as *complementary* colors. Similarly, you can increase and decrease a color by adjusting the two adjacent colors on the wheel, or even by adjusting the two colors adjacent to its opposite.

In a CMYK image, you can decrease magenta either by decreasing the amount of magenta or by increasing its complement, which is green (the color on the opposite side of the color wheel from magenta). In an RGB image, you can decrease magenta by removing red and blue or by adding green. All of these adjustments result in an overall color balance containing less magenta.

See also

“[Choose a color with the Adobe Color Picker](#)” on page 117

Color models, spaces, and modes

A color model describes the colors we see and work with in digital images. Each color model, such as RGB, CMYK, or HSB, represents a different method (usually numeric) for describing color.

A *color space* is a variant of a color model and has a specific *gamut* (range) of colors. For example, within the RGB color model are a number of color spaces: Adobe RGB, sRGB, ProPhoto RGB, and so on.

Each device, like your monitor or printer, has its own color space and can only reproduce colors in its gamut. When an image moves from one device to another, image colors may change because each device interprets the RGB or CMYK values according to its own color space. You can use color management when moving images to ensure that most colors are the same or similar enough so they appear consistent. See “[Why colors sometimes don’t match](#)” on page 126.

In Photoshop, a document’s *color mode* determines which color model is used to display and print the image you’re working on. Photoshop bases its color modes on the color models that are useful for images used in publishing. You can choose from RGB (Red, Green, Blue), CMYK (Cyan, Magenta, Yellow, Black), Lab Color (based on CIE L* a* b*), and Grayscale. Photoshop also includes modes for specialized color output such as Indexed Color and Duotone. Color modes determine the number of colors, the number of channels, and the file size of an image. Choosing a color mode also determines which tools and file formats are available.

When you work with the colors in an image, you are adjusting numerical values in the file. It’s easy to think of a number as a color, but these numerical values are not absolute colors in themselves—they only have a color meaning within the color space of the device that is producing the color.

See also

“[Color modes](#)” on page 106

Adjusting color hue, saturation, and brightness

Based on the human perception of color, the HSB model describes three fundamental characteristics of color:

Hue Color reflected from or transmitted through an object. It is measured as a location on the standard color wheel, expressed as a degree between 0° and 360°. In common use, hue is identified by the name of the color, such as red, orange, or green.

Saturation Strength or purity of the color (sometimes called *chroma*). Saturation represents the amount of gray in proportion to the hue, measured as a percentage from 0% (gray) to 100% (fully saturated). On the standard color wheel, saturation increases from the center to the edge.

Brightness Relative lightness or darkness of the color, usually measured as a percentage from 0% (black) to 100% (white).

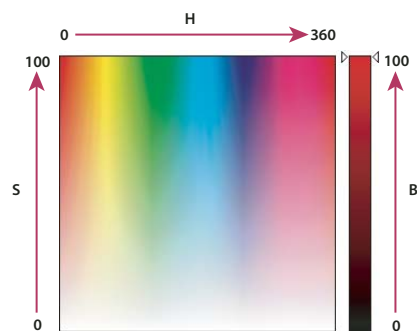

HSB color model

H. Hue S. Saturation B. Brightness

Color modes

RGB Color mode

Photoshop RGB Color mode uses the RGB model, assigning an intensity value to each pixel. In 8-bits-per-channel images, the intensity values range from 0 (black) to 255 (white) for each of the RGB (red, green, blue) components in a color image. For example, a bright red color has an R value of 246, a G value of 20, and a B value of 50. When the values of all three components are equal, the result is a shade of neutral gray. When the values of all components are 255, the result is pure white; when the values are 0, pure black.

RGB images use three colors, or *channels*, to reproduce colors on screen. In 8-bits-per-channel images, the three channels translate to 24 (8 bits x 3 channels) bits of color information per pixel. With 24-bit images, the three channels can reproduce up to 16.7 million colors per pixel. With 48-bit (16-bits-per-channel) and 96-bit (32-bits-per-channel) images, even more colors can be reproduced per pixel. In addition to being the default mode for new Photoshop images, the RGB model is used by computer monitors to display colors. This means that when working in color modes other than RGB, such as CMYK, Photoshop converts the CMYK image to RGB for display on screen.

Although RGB is a standard color model, the exact range of colors represented can vary, depending on the application or display device. The RGB Color mode in Photoshop varies according to the working space setting that you specify in the Color Settings dialog box.

See also

[“About color working spaces”](#) on page 144

CMYK Color mode

In the CMYK mode, each pixel is assigned a percentage value for each of the process inks. The lightest (highlight) colors are assigned small percentages of process ink colors; the darker (shadow) colors higher percentages. For example, a bright red might contain 2% cyan, 93% magenta, 90% yellow, and 0% black. In CMYK images, pure white is generated when all four components have values of 0%.

Use the CMYK mode when preparing an image to be printed using process colors. Converting an RGB image into CMYK creates a *color separation*. If you start with an RGB image, it's best to edit first in RGB and then convert to CMYK at the end of your editing process. In RGB mode, you can use the Proof Setup commands to simulate the effects of a CMYK conversion without changing the actual image data. You can also use CMYK mode to work directly with CMYK images scanned or imported from high-end systems.

Although CMYK is a standard color model, the exact range of colors represented can vary, depending on the press and printing conditions. The CMYK Color mode in Photoshop varies according to the working space setting that you specify in the Color Settings dialog box.

See also

[“About color working spaces”](#) on page 144

[“Soft-proof colors”](#) on page 135

Lab Color mode

The CIE L*a*b* color model (Lab) is based on the human perception of color. The numeric values in Lab describe all the colors that a person with normal vision sees. Because Lab describes how a color looks rather than how much of a particular colorant is needed for a device (such as a monitor, desktop printer, or digital camera) to produce colors, Lab is considered to be a *device-independent* color model. Color management systems use Lab as a color reference to predictably transform a color from one color space to another color space.

The Lab Color mode has a lightness component (L) that can range from 0 to 100. In the Adobe Color Picker and Color panel, the *a* component (green-red axis) and the *b* component (blue-yellow axis) can range from +127 to -128.

Lab images can be saved in Photoshop, Photoshop EPS, Large Document Format (PSB), Photoshop PDF, Photoshop Raw, TIFF, Photoshop DCS 1.0, or Photoshop DCS 2.0 formats. You can save 48-bit (16-bits-per-channel) Lab images in Photoshop, Large Document Format (PSB), Photoshop PDF, Photoshop Raw, or TIFF formats.

Note: The DCS 1.0 and DCS 2.0 formats convert the file to CMYK when opened.

Grayscale mode

Grayscale mode uses different shades of gray in an image. In 8-bit images, there can be up to 256 shades of gray. Every pixel of a grayscale image has a brightness value ranging from 0 (black) to 255 (white). In 16 and 32-bit images, the number of shades in an image is much greater than in 8-bit images.

Grayscale values can also be measured as percentages of black ink coverage (0% is equal to white, 100% to black).

Grayscale mode uses the range defined by the working space setting that you specify in the Color Settings dialog box.

See also

[“About color working spaces”](#) on page 144

Bitmap mode

Bitmap mode uses one of two color values (black or white) to represent the pixels in an image. Images in Bitmap mode are called bitmapped 1-bit images because they have a bit depth of 1.

Duotone mode

Duotone mode creates monotone, duotone (two-color), tritone (three-color), and quadtone (four-color) grayscale images using one to four custom inks.

See also

[“About duotones”](#) on page 488

Indexed Color mode

Indexed Color mode produces 8-bit image files with up to 256 colors. When converting to indexed color, Photoshop builds a *color lookup table (CLUT)*, which stores and indexes the colors in the image. If a color in the original image does not appear in the table, the program chooses the closest one or uses *dithering* to simulate the color using available colors.

Although its palette of colors is limited, indexed color can reduce file size yet maintain the visual quality needed for multimedia presentations, web pages, and the like. Limited editing is available in this mode. For extensive editing, you should convert temporarily to RGB mode. Indexed color files can be saved in Photoshop, BMP, DICOM (Digital Imaging and Communications in Medicine), GIF, Photoshop EPS, Large Document Format (PSB), PCX, Photoshop PDF, Photoshop Raw, Photoshop 2.0, PICT, PNG, Targa®, or TIFF formats.

Multichannel mode

Multichannel mode images contain 256 levels of gray in each channel and are useful for specialized printing. Multichannel mode images can be saved in Photoshop, Large Document Format (PSB), Photoshop 2.0, Photoshop Raw, or Photoshop DCS 2.0 formats.

These guidelines apply when converting images to Multichannel mode:

- Color channels in the original image become spot color channels in the converted image.
- Converting a CMYK image to Multichannel mode creates cyan, magenta, yellow, and black spot channels.
- Converting an RGB image to Multichannel mode creates cyan, magenta, and yellow spot channels.
- Deleting a channel from an RGB, CMYK, or Lab image automatically converts the image to Multichannel mode.
- To export a multichannel image, save it in Photoshop DCS 2.0 format.

Converting between color modes

Convert an image to another color mode

You can change an image from its original mode (source mode) to a different mode (target mode). When you choose a different color mode for an image, you permanently change the color values in the image. For example, when you convert an RGB image to CMYK mode, RGB color values outside the CMYK gamut (defined by the CMYK working space setting in the Color Settings dialog box) are adjusted to fall within gamut. As a result, some image data may be lost and can't be recovered if you convert the image from CMYK back to RGB.

Before converting images, it's best to do the following:

- Do as much editing as possible in the original image mode (usually RGB for images from most scanners or digital cameras, or CMYK for images from traditional drum scanners or imported from a Scitex system).
- Save a backup copy before converting. Be sure to save a copy of your image that includes all layers so that you can edit the original version of the image after the conversion.
- Flatten the file before converting it. The interaction of colors between layer blending modes changes when the mode changes.

Note: In most cases, you'll want to flatten a file before converting it. However, it isn't required and, in some cases, it isn't desirable (for example, when the file has vector text layers).

- ❖ Choose Image > Mode and the mode you want from the submenu. Modes not available for the active image appear dimmed in the menu.

Images are flattened when converted to Multichannel, Bitmap, or Indexed Color mode, because these modes do not support layers.

Add a conditional mode change to an action

You can specify conditions for a mode change so that the conversion can occur during an *action*, which is a series of commands applied sequentially to a single file or a batch of files. When a mode change is part of an action, an error can occur if the file being opened is not in the source mode specified in the action. For example, suppose one step in an action is to convert an image with a source mode of RGB to a target mode of CMYK. Applying this action to an image in Grayscale mode, or any other source mode besides RGB, results in an error.

When you record an action, you can use the Conditional Mode Change command to specify one or more modes for the source mode and a mode for the target mode.

- 1 Start recording an action.
- 2 Choose File > Automate > Conditional Mode Change.
- 3 In the Conditional Mode Change dialog box, select one or more modes for the source mode. Use the All or None buttons to select all possible modes or no mode.
- 4 Choose a target mode from the Mode pop-up menu.
- 5 Click OK. The conditional mode change appears as a new step in the Actions panel.

See also

[“Automating with actions”](#) on page 614

Convert a color photo to Grayscale mode

- 1 Open the photo you want to convert to black-and-white.
- 2 Choose Image > Mode > Grayscale.
- 3 Click Discard. Photoshop converts the colors in the image to black, white, and shades of gray.

Note: Converting a color photo to Grayscale mode results in a smaller file size, but discards color information and can result in two adjacent shades of gray being converted to the exact same shade of gray. Converting a color image to black and white results in a substantially larger file size but retains the color information and allows you to map from colors to shades of gray.

See also

[“Convert a color image to black and white”](#) on page 171

Convert an image to Bitmap mode

Converting an image to Bitmap mode reduces the image to two colors, greatly simplifying the color information in the image and reducing its file size.

When converting a color image to Bitmap mode, first convert it to Grayscale mode. This removes the hue and saturation information from the pixels and leaves just the brightness values. However, because only a few editing options are available for Bitmap mode images, it’s usually best to edit the image in Grayscale mode and then convert it to Bitmap mode.

Note: Images in Bitmap mode are 1 bit per channel. You must convert a 16- or 32-bits-per-channel image to 8-bit Grayscale mode before converting it to Bitmap mode.

- 1 Do one of the following:
 - If the image is in color, choose Image > Mode > Grayscale. Then choose Image > Mode > Bitmap.

- If the image is grayscale, choose Image > Mode > Bitmap.
- 2 For Output, enter a value for the output resolution of the Bitmap mode image, and choose a unit of measurement. By default, the current image resolution appears as both the input and the output resolutions.
 - 3 Choose one of the following bitmap conversion methods from the Use pop-up menu:

50% Threshold Converts pixels with gray values above the middle gray level (128) to white and pixels with gray values below that level to black. The result is a very high-contrast, black-and-white representation of the image.

Pattern Dither Converts an image by organizing the gray levels into geometric configurations of black and white dots.

Diffusion Dither Converts an image by using an error-diffusion process, starting at the pixel in the upper-left corner of the image. If the pixel's value is above middle gray (128), the pixel is changed to white—if below it, to black. Because the original pixel is rarely pure white or pure black, error is inevitably introduced. This error is transferred to surrounding pixels and diffused throughout the image, resulting in a grainy, film-like texture.

Halftone Screen Simulates the appearance of halftone dots in the converted image. Enter values in the Halftone Screen dialog box:

- For Frequency, enter a value for the screen frequency, and choose a unit of measurement. Values can range from 1.000 to 999.999 for lines per inch and from 0.400 to 400.00 for lines per centimeter. You can enter decimal values. The screen frequency specifies the ruling of the halftone screen in lines per inch (lpi). The frequency depends on the paper stock and type of press used for printing. Newspapers commonly use an 85-line screen. Magazines use higher resolution screens, such as 133-lpi and 150-lpi. Check with your print shop for correct screen frequencies.
- Enter a value for the screen angle in degrees from -180 to +180. The screen angle refers to the orientation of the screen. Continuous-tone and black-and-white halftone screens commonly use a 45° angle.
- For Shape, choose the dot shape you want.

Important: *The halftone screen becomes part of the image. If you print the image on a halftone printer, the printer will use its own halftone screen as well as the halftone screen that is part of the image. On some printers, the result is a moiré pattern.*

Custom Pattern Simulates the appearance of a custom halftone screen in the converted image. Choose a pattern that lends itself to thickness variations, typically one with a variety of gray shades.

To use this option, you first define a pattern and then screen the grayscale image to apply the texture. To cover the entire image, the pattern must be as large as the image. Otherwise, the pattern is tiled. Photoshop comes with several self-tiling patterns that can be used as halftone screen patterns.

💡 *To prepare a black-and-white pattern for conversion, first convert the image to grayscale and then apply the Blur More filter several times. This blurring technique creates thick lines tapering from dark gray to white.*

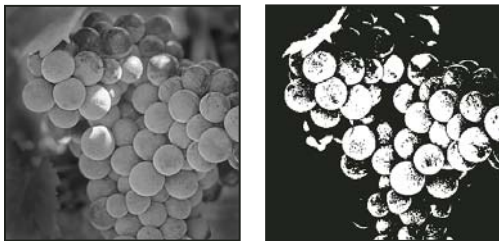

Original grayscale image, and 50% Threshold conversion method

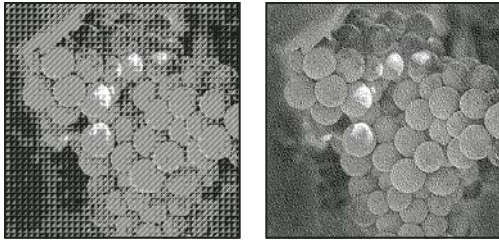

Pattern Dither conversion method, and Diffusion Dither conversion method

Convert a Bitmap mode image to Grayscale mode

You can convert a Bitmap mode image to Grayscale mode in order to edit it. Keep in mind that a Bitmap mode image edited in Grayscale mode may not look the same when you convert it back to Bitmap mode. For example, suppose a pixel that is black in Bitmap mode is edited to a shade of gray in Grayscale mode. When the image is converted back to Bitmap mode, that pixel is rendered as white if its gray value is above the middle gray value of 128.

- 1 Choose Image > Mode > Grayscale.
- 2 Enter a value between 1 and 16 for the size ratio.

The size ratio is the factor for scaling down the image. For example, to reduce a grayscale image by 50%, enter 2 for the size ratio. If you enter a number greater than 1, the program averages multiple pixels in the Bitmap mode image to produce a single pixel in the grayscale image. This process lets you generate multiple shades of gray from an image scanned on a 1-bit scanner.

Convert a grayscale or RGB image to indexed color

Converting to indexed color reduces the number of colors in the image to at most 256—the standard number of colors supported by the GIF and PNG-8 formats and many multimedia applications. This conversion reduces file size by deleting color information from the image.

To convert to indexed color, you must start with an image that is 8 bits per channel and in either Grayscale or RGB mode.

- 1 Choose Image > Mode > Indexed Color.

Note: All visible layers will be flattened; any hidden layers will be discarded.

For grayscale images, the conversion happens automatically. For RGB images, the Indexed Color dialog box appears.

- 2 Select Preview in the Indexed Color dialog box to display a preview of the changes.
- 3 Specify conversion options.

Conversion options for indexed-color images

When converting an RGB image to indexed color, you can specify a number of conversion options in the Indexed Color dialog box.

Palette Type A number of palette types are available for converting an image to indexed color. For the Perceptual, Selective, and Adaptive options, you can choose using a local palette based on the current image's colors. These are the available palette types:

- **Exact** Creates a palette using the exact colors appearing in the RGB image—an option available only if the image uses 256 or fewer colors. Because the image's palette contains all colors in the image, there is no dithering.
- **System (Mac OS)** Uses the Mac OS default 8-bit palette, which is based on a uniform sampling of RGB colors.

- **System (Windows)** Uses the Windows system's default 8-bit palette, which is based on a uniform sampling of RGB colors.
- **Web** Uses the 216-color palette that web browsers, regardless of platform, use to display images on a monitor limited to 256 colors. This palette is a subset of the Mac OS 8-bit palette. Use this option to avoid browser dither when viewing images on a monitor display limited to 256 colors.
- **Uniform** Creates a palette by uniformly sampling colors from the RGB color cube. For example, if Photoshop takes six evenly-spaced color levels each of red, green, and blue, the combination produces a uniform palette of 216 colors ($6 \text{ cubed} = 6 \times 6 \times 6 = 216$). The total number of colors displayed in an image corresponds to the nearest perfect cube (8, 27, 64, 125, or 216) that is less than the value in the Colors text box.
- **Local (Perceptual)** Creates a custom palette by giving priority to colors for which the human eye has greater sensitivity.
- **Local (Selective)** Creates a color table similar to the Perceptual color table, but favoring broad areas of color and the preservation of web colors. This option usually produces images with the greatest color integrity.
- **Local (Adaptive)** Creates a palette by sampling the colors from the spectrum appearing most commonly in the image. For example, an RGB image with only the colors green and blue produces a palette made primarily of greens and blues. Most images concentrate colors in particular areas of the spectrum. To control a palette more precisely, first select a part of the image containing the colors you want to emphasize. Photoshop weights the conversion toward these colors.
- **Master (Perceptual)** Creates a custom palette by giving priority to colors for which the human eye has greater sensitivity. Applies when you have multiple documents open; takes all open documents into account.
- **Master (Selective)** Creates a color table similar to the Perceptual color table, but favoring broad areas of color and the preservation of web colors. This option usually produces images with the greatest color integrity. Applies when you have multiple documents open; takes all open documents into account.
- **Master (Adaptive)** Creates a palette by sampling the colors from the spectrum appearing most commonly in the image. For example, an RGB image with only the colors green and blue produces a palette made primarily of greens and blues. Most images concentrate colors in particular areas of the spectrum. To control a palette more precisely, first select a part of the image containing the colors you want to emphasize. Photoshop weights the conversion toward these colors. Applies when you have multiple documents open; takes all open documents into account.
- **Custom** Creates a custom palette using the Color Table dialog box. Either edit the color table and save it for later use or click Load to load a previously created color table. This option also displays the current Adaptive palette, which is useful for previewing the colors most often used in the image.
- **Previous** Uses the custom palette from the previous conversion, making it easy to convert several images with the same custom palette.

Number Of Colors For the Uniform, Perceptual, Selective, or Adaptive palette, you can specify the exact number of colors to be displayed (up to 256) by entering a value for Colors. The Colors text box controls only how the indexed color table is created. Adobe Photoshop still treats the image as an 8-bit, 256-color image.

Color Inclusion And Transparency To specify colors to be included in the indexed color table or to specify transparency in the image, choose from the following options:

- **Forced** Provides options to force the inclusion of certain colors in the color table. Black And White adds a pure black and a pure white to the color table; Primaries adds red, green, blue, cyan, magenta, yellow, black, and white; Web adds the 216 web-safe colors; and Custom lets you define custom colors to add.
- **Transparency** Specifies whether to preserve transparent areas of the image during conversion. Selecting this option adds a special index entry in the color table for transparent colors. Deselecting this option fills transparent areas with the matte color, or with white if no matte color is chosen.

- **Matte** Specifies the background color used to fill anti-aliased edges that lie adjacent to transparent areas of the image. When Transparency is selected, the matte is applied to edge areas to help blend the edges with a web background of the same color. When Transparency is deselected, the matte is applied to transparent areas. Choosing None for the matte creates hard-edged transparency if Transparency is selected; otherwise, all transparent areas are filled with 100% white. The image must have transparency for the Matte options to be available.

Dithering Unless you're using the Exact color table option, the color table may not contain all the colors used in the image. To simulate colors not in the color table, you can dither the colors. Dithering mixes the pixels of the available colors to simulate the missing colors. Choose a dither option from the menu, and enter a percentage value for the dither amount. A higher amount dithers more colors but may increase file size. You can choose from the following dither options:

- **None** Does not dither colors but instead uses the color closest to the missing color. This tends to result in sharp transitions between shades of color in the image, creating a posterized effect.
- **Diffusion** Uses an error-diffusion method that produces a less-structured dither than the Pattern option. To protect colors in the image that contain entries in the color table from being dithered, select Preserve Exact Colors. This is useful for preserving fine lines and text for web images.
- **Pattern** Uses a halftone-like square pattern to simulate any colors not in the color table.
- **Noise** Helps to reduce seam patterns along the edges of image slices. Choose this option if you plan to slice the image for placement in an HTML table.

Customize indexed color tables

The Color Table command lets you make changes to the color table of an indexed-color image. These customization features are particularly useful with *pseudocolor images*—images displaying variations in gray levels with color rather than shades of gray, often used in scientific and medical applications. However, customizing the color table can also produce special effects with indexed-color images that have a limited number of colors.

Note: To shift colors simply in a pseudocolor image, choose Image > Adjustments, and use the color adjustment commands in the submenu.

Edit colors and assign transparency with a color table

You can edit colors in the color table to produce special effects, or assign transparency in the image to a single color in the table.

- 1 Open the indexed-color image.
- 2 Choose Image > Mode > Color Table.
- 3 To change a single color, click the color and choose a new color in the Color Picker.
- 4 To change a range of colors, drag in the table to choose the range of colors you want to change. In the Color Picker, choose the first color you want in the range and click OK. When the color picker redisplay, choose the last color you want in the range and click OK.

The colors you selected in the Color Picker are placed in the range you selected in the Color Table dialog box.

- 5 To assign transparency to a color, select the Eyedropper tool in the Color Table dialog box, and click the color in the table or in the image. The sampled color is replaced with transparency in the image.
- 6 Click OK in the Color Table dialog box to apply the new colors to the indexed-color image.

Choose a predefined color table

- 1 Open the indexed-color image.

2 Do one of the following:

- Choose Image > Mode > Color Table.
- Choose Image > Mode > Indexed Color. In the Indexed Color dialog box, choose Custom from the Panel pop-up menu. This opens the Color Table dialog box.

3 In the Color Table dialog box, choose a predefined table from the Table menu.

Custom Creates a palette you specify.

Black Body Displays a palette based on the different colors a black body radiator emits as it is heated—from black to red, orange, yellow, and white.

Grayscale Displays a palette based on 256 levels of gray—from black to white.

Spectrum Displays a palette based on the colors produced as white light passes through a prism—from violet, blue, and green to yellow, orange, and red.

System (Mac OS) Displays the standard Mac OS 256-color system palette.

System (Windows) Displays the standard Windows 256-color system palette.

Save and load color tables

You use the Save and Load buttons in the Color Table dialog box to save your indexed color tables for use with other Adobe Photoshop images. After you load a color table into an image, the colors in the image change to reflect the color positions they reference in the new color table.

Note: You can also load saved color tables into the Swatches panel.

Choosing colors

About foreground and background colors

Photoshop uses the *foreground* color to paint, fill, and stroke selections and the *background* color to make gradient fills and fill in the erased areas of an image. The foreground and background colors are also used by some special effects filters.

You can designate a new foreground or background color using the Eyedropper tool, the Color panel, the Swatches panel, or the Adobe Color Picker.

The default foreground color is black, and the default background color is white. (In an alpha channel, the default foreground is white, and the background is black.)

Choose colors in the toolbox

The current foreground color appears in the upper color selection box in the toolbox; the current background color appears in the lower box.

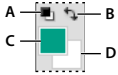

Foreground and background color boxes in toolbox

A. Default Colors icon B. Switch Colors icon C. Foreground color box D. Background color box

- To change the foreground color, click the upper color selection box in the toolbox, and then choose a color in the Adobe Color Picker.
- To change the background color, click the lower color selection box in the toolbox, and then choose a color in the Adobe Color Picker.
- To reverse the foreground and background colors, click the Switch Colors icon in the toolbox.
- To restore the default foreground and background colors, click the Default Colors icon in the toolbox.

See also

“[About the HDR Color Picker \(Photoshop Extended\)](#)” on page 76

Choose colors with the Eyedropper tool

The Eyedropper tool samples color to designate a new foreground or background color. You can sample from the active image or from anywhere else on the screen.

- 1 Select the Eyedropper tool .
- 2 To change the sample size of the eyedropper, choose an option from the Sample Size menu:

Point Sample Reads the precise value of the pixel you click.

3 by 3 Average, 5 by 5 Average, 11 by 11 Average, 31 by 31 Average, 51 by 51 Average, 101 by 101 Average Reads the average value of the specified number of pixels within the area you click.

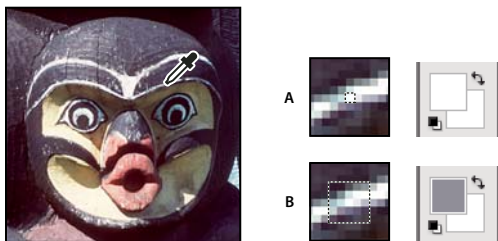

Selecting a foreground color with the Eyedropper tool

A. Point sample B. 5 x 5 average sample

- 3 Choose one of the following from the Sample menu:

All Layers Samples color from all layers in the document.

Current Layer Samples color from the currently active layer.

- 4 Do one of the following:

- To select a new foreground color, click in the image. Alternatively, position the pointer over the image, press the mouse button, and drag anywhere on the screen. The foreground color selection box changes dynamically as you drag. Release the mouse button to pick the new color.



- To select a new background color, Alt-click (Windows) or Option-click (Mac OS) in the image. Alternatively, position the pointer over the image, press Alt (Windows) or Options (Mac OS), press the mouse button, and drag anywhere on the screen. The background color selection box changes dynamically as you drag. Release the mouse button to pick the new color.

 To use the Eyedropper tool temporarily to select a foreground color while using any painting tool, hold down Alt (Windows) or Option (Mac OS).

Adobe Color Picker overview

In the Adobe Color Picker, you choose colors using four color models: HSB, RGB, Lab, and CMYK. Use the Adobe Color Picker to set the foreground color, background color, and text color. You can also set target colors for different tools, commands, and options.

You can configure the Adobe Color Picker to let you choose only colors that are part of the web-safe palette or choose from specific color systems. Photoshop Extended users can access an HDR (high dynamic range) picker to choose colors for use in HDR images.

The Color field in the Adobe Color Picker displays color components in HSB color mode, RGB color mode, and Lab color mode. If you know the numeric value of the color you want, you can enter it into the text fields. You can also use the color slider and the color field to preview a color to choose. As you adjust the color using the color field and color slider, the numeric values are adjusted accordingly. The color box to the right of the color slider displays the adjusted color in the top section and the original color in the bottom section. Alerts appear if the color is not a web-safe color  or is *out of gamut* for printing (non-printable) .

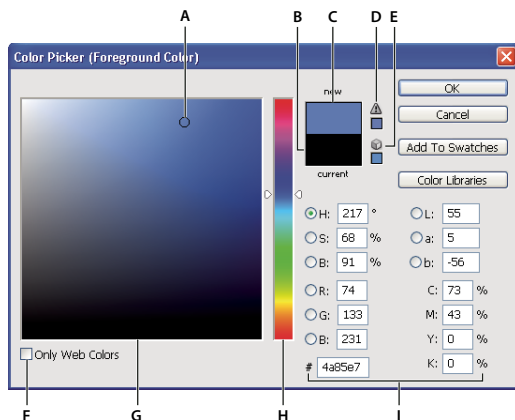

Adobe Color Picker

A. Picked color B. Original color C. Adjusted color D. Out-of-gamut alert icon E. Not a web-safe color alert icon F. Displays only web-safe colors G. Color field H. Color slider I. Color values

 When you select a color in the Adobe Color Picker, it simultaneously displays the numeric values for HSB, RGB, Lab, CMYK, and hexadecimal numbers. This is useful for viewing how the different color models describe a color.

Although Photoshop uses the Adobe Color Picker by default, you can use a different Color Picker than the Adobe Color Picker by setting a preference. For example, you can use the built-in color picker of your computer's operating system or a third-party plug-in Color Picker.

See also

“[About the HDR Color Picker \(Photoshop Extended\)](#)” on page 76

Display the Color Picker



- In the toolbox, click the foreground or background color selection box.
- In the Color panel, click the Set Foreground Color or Set Background Color selection box.

The Color Picker is also available when features let you choose a color. For example, by clicking the color swatch in the options bar for some tools, or the eyedroppers in some color adjustment dialog boxes.

Choose a color with the Adobe Color Picker

You can choose a color by entering color component values in HSB, RGB, and Lab text boxes, or by using the color slider and the color field.

To choose a color with the color slider and color field, click in the color slider or move the color slider triangle to set one color component. Then move the circular marker or click in the color field. This sets the other two color components.

As you adjust the color using the color field and color slider, the numeric values for the different color models adjust accordingly. The rectangle to the right of the color slider displays the new color in the top half and the original color in the bottom. Alerts appear if the color is not a web-safe color  or is *out of gamut* .

 You can choose a color outside the Adobe Color Picker window. Moving the pointer over the document window changes it to the Eyedropper tool. You can then select a color by clicking in the image. The selected color is displayed in the Adobe Color Picker. You can move the Eyedropper tool anywhere on your desktop by clicking in the image and then holding down the mouse button. You can select a color by releasing the mouse button.

Choose a color using the HSB model

Using the HSB color model, the hue is specified in the color field, as an angle from 0° to 360° that corresponds to a location on the color wheel. Saturation and brightness are specified as percentages. In the color field, the hue saturation increases from left to right and the brightness increases from the bottom to top.

- 1 In the Adobe Color Picker, select the H option and then enter a numeric value in the H text box or select a hue in the color slider.
- 2 Adjust the saturation and brightness by clicking in the color field, moving the circular marker, or entering numeric values in the S and B text boxes.
- 3 (Optional) Select either the S option or B option to display the color's saturation or brightness in the color field for making further adjustments.

Choose a color using the RGB model

Choose a color by specifying its red, green, and blue components.

- 1 In the Adobe Color Picker, enter numeric values in the R, G, and B text boxes. Specify component values from 0 to 255 (0 is no color, and 255 is the pure color).
- 2 To visually select a color using the color slider and color field, click either R, G, or B and then adjust the slider and color field.

The color you click appears in the color slider with 0 (none of that color) at the bottom and 255 (maximum amount of that color) at the top. The color field displays the range of the other two components, one on the horizontal axis and one on the vertical axis.

Choose a color using the Lab model

When choosing a color based on the Lab color model, the L value specifies the luminance of a color. The A value specifies how red or green a color is. The B value specifies how blue or yellow a color is.

- 1 In the Adobe Color Picker, enter values for L (from 0 to 100), and for A and B (from -128 to +127).
- 2 (Optional) Use the color slider or color field to adjust the color.

Choose a color using the CMYK model

You can choose a color by specifying each component value as a percentage of cyan, magenta, yellow, and black.

- ❖ In the Adobe Color Picker, enter percentage values for C, M, Y, and K, or use the color slider and color field to choose a color.

Choose a color by specifying a hexadecimal value

You can choose a color by specifying a hexadecimal value that defines the R, G, and B components in a color. The three pairs of numbers are expressed in values from 00 (minimum luminance) to ff (maximum luminance). For example, 000000 is black, ffffff is white, and ff0000 is red.

- ❖ In the Adobe Color Picker, enter a hexadecimal value in the # text box.

Choose web-safe colors

The *web-safe colors* are the 216 colors used by browsers regardless of the platform. The browser changes all colors in the image to these colors when displaying the image on an 8-bit screen. The 216 colors are a subset of the Mac OS 8-bit color palettes. By working only with these colors, you can be sure that art you prepare for the web will not dither on a system set to display 256 colors.

Select web-safe colors in the Adobe Color Picker

- ❖ Select the Only Web Colors option in the lower left corner of the Color Picker. Any color you pick with this option selected is web-safe.

Change a non-web color to a web-safe color

If you select a non-web color, an alert cube  appears next to the color rectangle in the Adobe Color Picker.

- ❖ Click the alert cube to select the closest web color. (If no alert cube appears, the color you chose is web-safe.)

Select a web-safe color using the Color panel

- 1 Click the Color panel tab, or choose Window > Color to view the Color panel.
- 2 Choose an option for selecting a web-safe color:
 - Choose Make Ramp Web Safe from the Color panel menu. Any color you pick with this option selected is web-safe.
 - Choose Web Color Sliders from the Color panel menu. By default, web color sliders snap to web-safe colors (indicated by tick marks) when you drag them. To override web-safe color selection, Alt-drag (Windows) or Option-drag (Mac OS) the sliders.

If you choose a non-web color, an alert cube  appears above the color ramp on the left side of the Color panel. Click the alert cube to select the closest web color.

Choose a CMYK equivalent for a non-printable color

Some colors in the RGB, HSB, and Lab color models cannot be printed because they are out-of-gamut and have no equivalents in the CMYK model. When you choose a non-printable color in either the Adobe Color Picker or the Color panel, a warning alert triangle appears. A swatch below the triangle displays the closest CMYK equivalent.

Note: In the Color panel, the alert triangle is not available if you are using Web Color Sliders.

- ❖ To choose the closest CMYK equivalent, click the alert triangle  in the Color Picker dialog box or the Color panel.

Printable colors are determined by the current CMYK working space defined in the Color Settings dialog box.

See also

[“Identify out-of-gamut colors”](#) on page 160

Choose a spot color

The Adobe Color Picker lets you choose colors from the PANTONE MATCHING SYSTEM®, the Trumatch® Swatching System™, the Focoltone® Colour System, the Toyo Color Finder™ 1050 system, the ANPA-Color™ system, the HKS® color system, and the DIC Color Guide.

To ensure that the final printed output is the color you want, consult your printer or service bureau and choose your color based on a printed color swatch. Manufacturers recommend that you get a new swatch book each year to compensate for fading inks and other damage.

Important: Photoshop prints spot colors to CMYK (process color) plates in every image mode except Duotone. To print true spot color plates, create spot color channels.

- 1 Open the Adobe Color Picker, and click Color Libraries.

The Custom Colors dialog box displays the color closest to the color currently selected in the Adobe Color Picker.

- 2 For Book, choose a color library. See below for descriptions of the color libraries.
- 3 Locate the color you want by entering the ink number or by dragging the triangles along the scroll bar.
- 4 Click the desired color patch in the list.

See also

[“About spot colors”](#) on page 491

Spot color libraries

The Adobe Color Picker supports the following color systems:

ANPA-COLOR Commonly used for newspaper applications. The *ANPA-COLOR ROP Newspaper Color Ink Book* contains samples of the ANPA colors.

DIC Color Guide Commonly used for printing projects in Japan. For more information, contact Dainippon Ink & Chemicals, Inc., in Tokyo, Japan.

FOCOLTONE Consists of 763 CMYK colors. Focoltone colors help avoid prepress trapping and registration problems by showing the overprints that make up the colors. A swatch book with specifications for process and spot colors, overprint charts, and a chip book for marking up layouts are available from Focoltone. For more information, contact Focoltone International, Ltd., in Stafford, United Kingdom.

HKS swatches Used for printing projects in Europe. Each color has a specified CMYK equivalent. You can select from HKS E (for continuous stationery), HKS K (for gloss art paper), HKS N (for natural paper), and HKS Z (for newsprint). Color samplers for each scale are available. HKS Process books and swatches have been added to the color system menu.

PANTONE® Colors used for spot-color reproduction. The PANTONE MATCHING SYSTEM can render 1,114 colors. PANTONE color guides and chip books are printed on coated, uncoated, and matte paper stocks to ensure accurate visualization of the printed result and better on-press control. You can print a solid PANTONE color in CMYK. To compare a solid PANTONE color to its closest process color match, use the *PANTONE solid to process* guide. The CMYK screen tint percentages are printed under each color. For more information, contact Pantone, Inc., Carlstadt, NJ (www.pantone.com).

TOYO Color Finder 1050 Consists of more than 1000 colors based on the most common printing inks used in Japan. The *TOYO Process Color Finder* book and swatches have been added to the color system menu. The *TOYO Color Finder 1050 Book* contains printed samples of Toyo colors and is available from printers and graphic arts supply stores. For more information, contact Toyo Ink Manufacturing Co., Ltd., in Tokyo, Japan.

TRUMATCH Provides predictable CMYK color matching with more than 2000 achievable, computer-generated colors. Trumatch colors cover the visible spectrum of the CMYK gamut in even steps. The Trumatch Color displays up to 40 tints and shades of each hue, each originally created in four-color process and each reproducible in four colors on electronic imagesetters. In addition, four-color grays using different hues are included. For more information, contact Trumatch Inc., in New York City, New York.

Change the Color Picker

Instead of using the Adobe Color Picker, you can choose colors from your computer operating system's standard Color Picker or from a third party Color Picker.

- 1 Choose Edit > Preferences > General (Windows) or Photoshop > Preferences > General (Mac OS).
- 2 Choose a Color Picker from the Color Picker menu, and click OK.

For more information, see your operating system documentation.

Note: To return to the Adobe Color Picker, choose it from the Color Picker menu in the General Preferences.

Color panel overview

The Color panel (Window > Color) displays the color values for the current foreground and background colors. Using the sliders in the Color panel, you can edit the foreground and background colors using different color models. You can also choose a foreground or background color from the spectrum of colors displayed in the color ramp at the bottom of the panel.

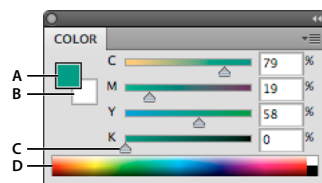

Color panel
A. Foreground color B. Background color C. Slider D. Color ramp

The Color panel may display the following alerts when you select a color:

- An exclamation point inside a triangle  appears above the left side of the color ramp when you choose a color that cannot be printed using CMYK inks.

- A square  appears above the left side of the color ramp when you choose a color that is not web-safe.

See also

[“Identify out-of-gamut colors”](#) on page 160

[“Color modes”](#) on page 106

Change the color model of the Color panel sliders

- ❖ Choose a Sliders option from the Color panel menu.

Change the spectrum displayed in the Color panel

- 1 Choose an option from the Color panel menu:
 - RGB Spectrum, CMYK Spectrum, or Grayscale Ramp to display the spectrum of the specified color model.
 - Current Colors to display the spectrum of colors between the current foreground color and the current background color.
- 2 To display only web-safe colors, choose Make Ramp Web Safe.



To change the spectrum of the color ramp quickly, Shift-click in the color ramp until you see the spectrum you want.

Select a color in the Color panel

- 1 To edit the foreground or background color, make sure that its color selection box is active (outlined in black) in the Color panel. To make the foreground or background color selection box active, click the box.
- 2 Do one of the following:
 - Drag the color sliders. By default, the slider colors change as you drag. You can turn off this feature to improve performance by deselecting Dynamic Color Sliders in the General section of the Preferences dialog box.
 - Enter values next to the color sliders.
 - Click the color selection box, choose a color using the Color Picker and click OK.
 - Position the pointer over the color ramp (the pointer becomes the eyedropper), and click to sample a color. Alt-click to apply the sample to the non-active color selection box.

See also

[“Adobe Color Picker overview”](#) on page 116

Select a color in the Swatches panel

The Swatches panel (Window > Swatches) stores colors that you use often. You can add or delete colors from the panel or display different libraries of colors for different projects.

- To choose a foreground color, click a color in the Swatches panel.
- To choose a background color, Ctrl-click (Windows) or Command-click (Mac OS) a color in the Swatches panel.

Note: Change how swatches are displayed by choosing an option from the Swatches panel menu.

Add and delete color swatches

Color swatches can be added or deleted from the Swatches panel.

 You can also add a color swatch from the Color Picker by clicking the Add To Swatches button.

Add a color to the Swatches panel

- 1 Decide which color you want to add and make it the foreground color.
- 2 Do one of the following:
 - Click the New Swatch button  in the Swatches panel. Alternatively, choose New Swatch from the Swatches panel menu.
 - Position the pointer over an empty space in the bottom row of the Swatches panel (the pointer turns into the Paint Bucket tool), and click to add the color. Enter a name for the new color and click OK.



Color selected from image (left), and added to Swatches panel (right)

Note: New colors are saved in the Photoshop preferences file so that they persist between editing sessions. To permanently save a color, save it in a library.

Delete a color from the Swatches panel

- ❖ Do one of the following:
 - Drag a swatch to the Delete icon .
 - Hold down Alt (Windows) or Option (Mac OS), position the pointer over a swatch (the pointer turns into scissors), and click.

Manage swatch libraries

Swatch libraries provide an easy way to access different sets of colors. Custom sets of swatches can be saved as a library for reuse. Swatches can also be saved in a format for sharing in other applications.

See also

[“Work with the Preset Manager”](#) on page 41

[“Share swatches between applications”](#) on page 123

Load or replace a library of swatches

- ❖ Choose one of the following from the Swatches panel menu:

Load Swatches Adds a library to the current set of swatches. Select the library file you want to use, and click Load.

Replace Swatches Replaces the current list with a different library. Select the library file you want to use, and click Load. Photoshop gives you the option of saving the current set of swatches before replacing them.

Name of a color library Loads a specific color system listed in the lower part of the Swatches panel menu. You can either replace or append the current set of colors with the library you’re loading.

Save a set of swatches as a library

- 1 Choose Save Swatches from the Swatches panel menu.
- 2 Choose a location for the swatch library, enter a file name, and click Save.

You can save the library anywhere. However, if you place the library file in the Presets/Swatches folder in the default presets location, the library name will appear at the bottom of the Swatches panel menu after you restart the application.

Return to the default library of swatches

- ❖ Choose Reset Swatches from the Swatches panel menu. You can either replace or append the current set of colors with the default swatch library.

Share swatches between applications

You can share the solid swatches you create in Photoshop, Illustrator, and InDesign by saving a swatch library for exchange. The colors appear exactly the same across applications as long as your color settings are synchronized.

- 1 In the Swatches panel, create the process and spot-color swatches you want to share, and remove any swatches you don't want to share.

Note: You cannot share the following types of swatches between applications: patterns, gradients, and the Registration swatch from Illustrator or InDesign; and book color references, HSB, XYZ, duotone, monitorRGB, opacity, total ink, and webRGB swatches from Photoshop. These types of swatches are automatically excluded when you save swatches for exchange.

- 2 Select Save Swatches For Exchange from the Swatches panel menu, and save the swatch libraries in an easily accessible location.
- 3 Load the swatch library into the Swatches panel for Photoshop, Illustrator, or InDesign.

Kuler panel

About the Kuler panel

The Kuler™ panel is your portal to groups of colors, or themes, created by an online community of designers. You can use it to browse thousands of themes on Kuler™, and then download some to edit or to include in your own projects. You can also use the Kuler panel to create and save themes, and then share them with the Kuler community by uploading them.

The Kuler panel is available in Adobe Photoshop® CS4, Adobe Flash® Professional CS4, Adobe InDesign® CS4, Adobe Illustrator® CS4, and Adobe Fireworks® CS4. The panel is not available in the French versions of these products.

For a video on the Kuler panel, see www.adobe.com/go/lrvid4088_xp.

For an article on Kuler and color inspiration, see Veerle Pieters' blog at http://veerle.duoh.com/blog/comments/adobe_kuler_update_and_color_tips/.

Browse themes

An Internet connection is required to browse themes online.

Search themes

- 1 Select Window > Extensions > Kuler, and then select the Browse panel.
- 2 Do either of the following:
 - In the Search box, enter the name of a theme, tag, or creator.
Note: Use only alphanumerical characters (Aa-Zz, 0-9) in searches.
 - Filter the search results by selecting an option from the pop-up menus above the results.

View a theme online on Kuler

- 1 In the Browse panel, select a theme in the search results.
- 2 Click the triangle on the right side of the theme and select View Online in Kuler.

Saving frequent searches

- 1 Select the Custom option in the first pop-up menu in the Browse panel.
- 2 In the dialog box that opens, enter your search terms and save them.

When you want to run the search, select it from the first pop-up menu.

To delete a saved search, select the Custom option in the pop-up menu. Then clear the searches you want to delete, and click Save.

Working with themes

You can use the Kuler panel to create or edit themes, and include them in your projects.

Note: In Illustrator, you create and edit themes with the Edit Color/Recolor Artwork dialog box, rather than the Create panel. For details, see Illustrator Help.

Add a theme to the Swatches panel of your application

- 1 In the Browse panel, select a theme you want to use.
- 2 Click the triangle on the right side of the theme and select Add To Swatches Panel.

You can also add a theme from the Create panel by clicking the Add To Swatches button at the bottom of the panel.

Edit a theme

- 1 In the Browse panel, locate a theme you want to edit and then double-click the theme in the search results. The theme opens in the Create panel.
- 2 In the Create panel, edit the theme using the tools at your disposal. For more information, see the Create Panel Tools topic that follows.
- 3 Do one of the following:
 - Save your theme by clicking the Save Theme button.
 - Add the theme to your application's Swatches panel by clicking the Add To Swatches Panel button at the bottom of the panel.
 - Upload the theme to the Kuler service by clicking the Upload button at the bottom of the panel.

Create panel tools

The Create panel provides a variety of tools to create or edit themes.

- Select a harmony rule from the Select Rule pop-up menu. The harmony rule uses the base color as the basis for generating the colors in the color group. For example, if you choose a blue base color and the Complementary harmony rule, a color group is created using the base color, blue, and its complement, red.
- Select the Custom rule to create a theme using free-form adjustments.
- Manipulate the colors in the color wheel. As you make your adjustments, the selected harmony rule continues to govern the colors generated for the color group.
- Move the Brightness slider beside the wheel to adjust the color brightness.
- Set the base color by dragging the Base color marker (the largest, double-ringed color marker) around the wheel. You can also set the base color by adjusting the color sliders at the bottom of the dialog box.
- Set one of the four other colors in the color group as the base color. Select the color's swatch and click the bull's-eye button below the color group.
- Set the host application's foreground/background color or stroke/fill color as the base color. Click one of the first two buttons below the color group.
- Remove a color from the color group by selecting the color's swatch and clicking the Remove Color button below the color group. Add a new color by selecting an empty color swatch and clicking the Add Color button.
- Try different color effects by selecting a new harmony rule and by moving the markers in the color wheel.
- Double-click any of the swatches in the color group to set the active color (foreground/background or stroke/fill) in your application. If the application doesn't have an active or selected color feature, the Kuler panel sets the foreground color or the fill color as appropriate.

Chapter 6: Color management

A color management system reconciles color differences among devices so that you can be reasonably certain of the colors your system ultimately produces. Viewing color accurately allows you to make sound color decisions throughout your workflow, from digital capture through final output. Color management also allows you to create output based on ISO, SWOP, and Japan Color print production standards.

Understanding color management

Why colors sometimes don't match

No device in a publishing system is capable of reproducing the full range of colors viewable to the human eye. Each device operates within a specific color space that can produce a certain range, or *gamut*, of colors.

A color model determines the relationship between values, and the color space defines the absolute meaning of those values as colors. Some color models (such as CIE L*a*b) have a fixed color space because they relate directly to the way humans perceive color. These models are described as being *device-independent*. Other color models (RGB, HSL, HSB, CMYK, and so forth) can have many different color spaces. Because these models vary with each associated color space or device, they are described as being *device-dependent*.

Because of these varying color spaces, colors can shift in appearance as you transfer documents between different devices. Color variations can result from differences in image sources; the way software applications define color; print media (newsprint paper reproduces a smaller gamut than magazine-quality paper); and other natural variations, such as manufacturing differences in monitors or monitor age.

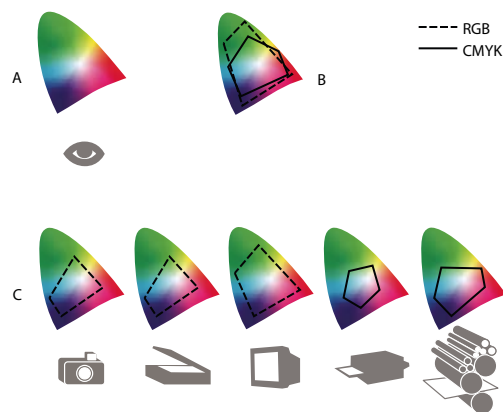

Color gamuts of various devices and documents
A. Lab color space B. Documents (working space) C. Devices

What is a color management system?

Color-matching problems result from various devices and software using different color spaces. One solution is to have a system that interprets and translates color accurately between devices. A color management system (CMS) compares the color space in which a color was created to the color space in which the same color will be output, and makes the necessary adjustments to represent the color as consistently as possible among different devices.

A color management system translates colors with the help of *color profiles*. A profile is a mathematical description of a device's color space. For example, a scanner profile tells a color management system how your scanner "sees" colors. Adobe color management uses ICC profiles, a format defined by the International Color Consortium (ICC) as a cross-platform standard.

Because no single color-translation method is ideal for all types of graphics, a color management system provides a choice of *rendering intents*, or translation methods, so that you can apply a method appropriate to a particular graphics element. For example, a color translation method that preserves correct relationships among colors in a wildlife photograph may alter the colors in a logo containing flat tints of color.

Note: Don't confuse color management with color correction. A color management system won't correct an image that was saved with tonal or color balance problems. It provides an environment where you can evaluate images reliably in the context of your final output.

See also

["About color profiles"](#) on page 139

["About rendering intents"](#) on page 148

Do you need color management?

Without a color management system, your color specifications are device-dependent. You might not need color management if your production process is tightly controlled for one medium only. For example, you or your print service provider can tailor CMYK images and specify color values for a known, specific set of printing conditions.

The value of color management increases when you have more variables in your production process. Color management is recommended if you anticipate reusing color graphics for print and online media, using various kinds of devices within a single medium (such as different printing presses), or if you manage multiple workstations.

You will benefit from a color management system if you need to accomplish any of the following:

- Get predictable and consistent color output on multiple output devices including color separations, your desktop printer, and your monitor. Color management is especially useful for adjusting color for devices with a relatively limited gamut, such as a four-color process printing press.
- Accurately soft-proof (preview) a color document on your monitor by making it simulate a specific output device. (Soft-proofing is subject to the limitations of monitor display, and other factors such as room lighting conditions.)
- Accurately evaluate and consistently incorporate color graphics from many different sources if they also use color management, and even in some cases if they don't.
- Send color documents to different output devices and media without having to manually adjust colors in documents or original graphics. This is valuable when creating images that will eventually be used both in print and online.
- Print color correctly to an unknown color output device; for example, you could store a document online for consistently reproducible on-demand color printing anywhere in the world.

Creating a viewing environment for color management

Your work environment influences how you see color on your monitor and on printed output. For best results, control the colors and light in your work environment by doing the following:

- View your documents in an environment that provides a consistent light level and color temperature. For example, the color characteristics of sunlight change throughout the day and alter the way colors appear on your screen, so keep shades closed or work in a windowless room. To eliminate the blue-green cast from fluorescent lighting, you can install D50 (5000° Kelvin) lighting. You can also view printed documents using a D50 lightbox.
- View your document in a room with neutral-colored walls and ceiling. A room's color can affect the perception of both monitor color and printed color. The best color for a viewing room is neutral gray. Also, the color of your clothing reflecting off the glass of your monitor may affect the appearance of colors on-screen.
- Remove colorful background patterns on your monitor desktop. Busy or bright patterns surrounding a document interfere with accurate color perception. Set your desktop to display neutral grays only.
- View document proofs in the real-world conditions under which your audience will see the final piece. For example, you might want to see how a housewares catalog looks under the incandescent light bulbs used in homes, or view an office furniture catalog under the fluorescent lighting used in offices. However, always make final color judgements under the lighting conditions specified by the legal requirements for contract proofs in your country.

Keeping colors consistent

About color management in Adobe applications

Adobe color management helps you maintain the appearance of colors as you bring images in from external sources, edit documents and transfer them between Adobe applications, and output your finished compositions. This system is based on conventions developed by the International Color Consortium, a group responsible for standardizing profile formats and procedures so that consistent and accurate color can be achieved throughout a workflow.

By default, color management is turned on in color-managed Adobe applications. If you purchased the Adobe Creative Suite, color settings are synchronized across applications to provide consistent display for RGB and CMYK colors. This means that colors look the same no matter which application you view them in.

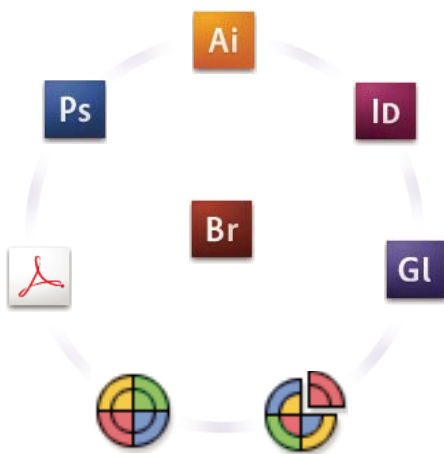

Color settings for Adobe Creative Suite are synchronized in a central location through Adobe Bridge.

If you decide to change the default settings, easy-to-use presets let you configure Adobe color management to match common output conditions. You can also customize color settings to meet the demands of your particular color workflow.

Keep in mind that the kinds of images you work with and your output requirements influence how you use color management. For example, there are different color-consistency issues for an RGB photo printing workflow, a CMYK commercial printing workflow, a mixed RGB/CMYK digital printing workflow, and an Internet publishing workflow.

Basic steps for producing consistent color

1. Consult with your production partners (if you have any) to ensure that all aspects of your color management workflow integrate seamlessly with theirs.

Discuss how the color workflow will be integrated with your workgroups and service providers, how software and hardware will be configured for integration into the color management system, and at what level color management will be implemented. (See “[Do you need color management?](#)” on page 127.)

2. Calibrate and profile your monitor.

A monitor profile is the first profile you should create. Seeing accurate color is essential if you are making creative decisions involving the color you specify in your document. (See “[Calibrate and profile your monitor](#)” on page 141.)

3. Add color profiles to your system for any input and output devices you plan to use, such as scanners and printers.

The color management system uses profiles to know how a device produces color and what the actual colors in a document are. Device profiles are often installed when a device is added to your system. You can also use third-party software and hardware to create more accurate profiles for specific devices and conditions. If your document will be commercially printed, contact your service provider to determine the profile for the printing device or press condition. (See “[About color profiles](#)” on page 139 and “[Install a color profile](#)” on page 141.)

4. Set up color management in Adobe applications.

The default color settings are sufficient for most users. However, you can change the color settings by doing one of the following:

- If you use multiple Adobe applications, use Adobe® Bridge CS3 to choose a standard color management configuration and synchronize color settings across applications before working with documents. (See “[Synchronize color settings across Adobe applications](#)” on page 130.)
- If you use only one Adobe application, or if you want to customize advanced color management options, you can change color settings for a specific application. (See “[Set up color management](#)” on page 130.)

5. (Optional) Preview colors using a soft proof.

After you create a document, you can use a soft proof to preview how colors will look when printed or viewed on a specific device. (See “[About soft-proofing colors](#)” on page 134.)

***Note:** A soft proof alone doesn't let you preview how overprinting will look when printed on an offset press. If you work with documents that contain overprinting, turn on Overprint Preview to accurately preview overprints in a soft proof. For Acrobat, the Overprint Preview option is automatically applied.*

6. Use color management when printing and saving files.

Keeping the appearance of colors consistent across all of the devices in your workflow is the goal of color management. Leave color management options enabled when printing documents, saving files, and preparing files for online viewing. (See “[Printing with color management](#)” on page 137 and “[Color-managing documents for online viewing](#)” on page 133.)

Synchronize color settings across Adobe applications

If you use Adobe Creative Suite, you can use Adobe Bridge to automatically synchronize color settings across applications. This synchronization ensures that colors look the same in all color-managed Adobe applications.

If color settings are not synchronized, a warning message appears at the top of the Color Settings dialog box in each application. Adobe recommends that you synchronize color settings before you work with new or existing documents.

1 Open Bridge.

To open Bridge from a Creative Suite application, choose File > Browse. To open Bridge directly, either choose Adobe Bridge from the Start menu (Windows) or double-click the Adobe Bridge icon (Mac OS).

2 Choose Edit > Creative Suite Color Settings.

3 Select a color setting from the list, and click Apply.

If none of the default settings meet your requirements, select Show Expanded List Of Color Setting Files to view additional settings. To install a custom settings file, such as a file you received from a print service provider, click Show Saved Color Settings Files.

Set up color management

1 Do one of the following:

- (Illustrator, InDesign, Photoshop) Choose Edit > Color Settings.
- (Acrobat) Select the Color Management category of the Preferences dialog box.

2 Select a color setting from the Settings menu, and click OK.

The setting you select determines which color working spaces are used by the application, what happens when you open and import files with embedded profiles, and how the color management system converts colors. To view a description of a setting, select the setting and then position the pointer over the setting name. The description appears at the bottom of the dialog box.

Note: Acrobat color settings are a subset of those used in InDesign, Illustrator, and Photoshop.

In certain situations, such as if your service provider supplies you with a custom output profile, you may need to customize specific options in the Color Settings dialog box. However, customizing is recommended for advanced users only.

Note: If you work with more than one Adobe application, it is highly recommended that you synchronize your color settings across applications. (See “[Synchronize color settings across Adobe applications](#)” on page 130.)

See also

“[Customize color settings](#)” on page 144

Change the appearance of CMYK black (Illustrator, InDesign)

Pure CMYK black (K=100) appears jet black (or rich black) when viewed on-screen, printed to a non-PostScript desktop printer, or exported to an RGB file format. If you prefer to see the difference between pure black and rich black as it will appear when printed on a commercial press, you can change the Appearance Of Black preferences. These preferences do not change the color values in a document.

1 Choose Edit > Preferences > Appearance Of Black (Windows) or [*application name*] > Preferences > Appearance Of Black (Mac OS).

2 Choose an option for On Screen:

Display All Blacks Accurately Displays pure CMYK black as dark gray. This setting allows you to see the difference between pure black and rich black.

Display All Blacks As Rich Black Displays pure CMYK black as jet black (RGB=000). This setting makes pure black and rich black appear the same on-screen.

3 Choose an option for Printing/Exporting:

Output All Blacks Accurately When printing to a non-PostScript desktop printer or exporting to an RGB file format, outputs pure CMYK black using the color numbers in the document. This setting allows you to see the difference between pure black and rich black.

Output All Blacks As Rich Black When printing to a non-PostScript desktop printer or exporting to an RGB file format, outputs pure CMYK black as jet black (RGB=000). This setting makes pure black and rich black appear the same.

Managing process and spot colors

When color management is on, any color you apply or create within a color-managed Adobe application automatically uses a color profile that corresponds to the document. If you switch color modes, the color management system uses the appropriate profiles to translate the color to the new color model you choose.

Keep in mind the following guidelines for working with process and spot colors:

- Choose a CMYK working space that matches your CMYK output conditions to ensure that you can accurately define and view process colors.
- Select colors from a color library. Adobe applications come with several standard color libraries, which you can load using the Swatches panel menu.
- (Illustrator, and InDesign) Turn on Overprint Preview to get an accurate and consistent preview of spot colors.
- (Acrobat, Illustrator, and InDesign) Use Lab values (the default) to display predefined spot colors (such as colors from the TOYO, PANTONE, DIC, and HKS libraries) and convert these colors to process colors. Using Lab values provides the greatest accuracy and guarantees the consistent display of colors across Creative Suite applications. If you want the display and output of these colors to match earlier versions of Illustrator or InDesign, use CMYK equivalent values instead. For instructions on switching between Lab values and CMYK values for spot colors, search Illustrator or InDesign Help.

***Note:** Color-managing spot colors provides a close approximation of a spot color on your proofing device and monitor. However, it is difficult to exactly reproduce a spot color on a monitor or proofing device because many spot color inks exist outside the gamuts of many of those devices.*

Color-managing imported images

Color-managing imported images (Illustrator, InDesign)

How imported images are integrated into a document's color space depends on whether or not the image has an embedded profile:

- When you import an image that contains no profile, the Adobe application uses the current document profile to define the colors in the image.
- When you import an image that contains an embedded profile, color policies in the Color Settings dialog box determine how the Adobe application handles the profile.

See also

[“Color management policy options”](#) on page 146

Using a safe CMYK workflow

A safe CMYK workflow ensures that CMYK color numbers are preserved all the way to the final output device, as opposed to being converted by your color management system. This workflow is beneficial if you want to incrementally adopt color management practices. For example, you can use CMYK profiles to soft-proof and hard-proof documents without the possibility of unintended color conversions occurring during final output.

Illustrator and InDesign support a safe CMYK workflow by default. As a result, when you open or import a CMYK image with an embedded profile, the application ignores the profile and preserves the raw color numbers. If you want your application to adjust color numbers based on an embedded profile, change the CMYK color policy to Preserve Embedded Profiles in the Color Settings dialog box. You can easily restore the safe CMYK workflow by changing the CMYK color policy back to Preserve Numbers (Ignore Linked Profiles).

You can override safe CMYK settings when you print a document or save it to Adobe PDF. However, doing so may cause colors to be re-separated. For example, pure CMYK black objects may be re-separated as rich black. For more information on color management options for printing and saving PDFs, search in Help.

See also

[“Color management policy options”](#) on page 146

Preparing imported graphics for color management

Use the following general guidelines to prepare graphics for being color-managed in Adobe applications:

- Embed an ICC-compliant profile when you save the file. The file formats that support embedded profiles are JPEG, PDF, PSD (Photoshop), AI (Illustrator), INDD (InDesign), Photoshop EPS, Large Document Format, and TIFF.
- If you plan to reuse a color graphic for multiple final output devices or media, such as for print, video, and the web, prepare the graphic using RGB or Lab colors whenever possible. If you must save in a color model other than RGB or Lab, keep a copy of the original graphic. RGB and Lab color models represent larger color gamuts than most output devices can reproduce, retaining as much color information as possible before being translated to a smaller output color gamut.

See also

[“Embed a color profile”](#) on page 142

View or change profiles for imported bitmap images (InDesign)

InDesign allows you to view, override, or disable profiles for imported bitmap images. This may be necessary when you are importing an image containing no profile or an incorrectly embedded profile. For example, if the scanner manufacturer's default profile was embedded but you have since generated a custom profile, you can assign the newer profile.

- 1 Do one of the following:
 - If the graphic is already in layout, select it and choose Object > Image Color Settings.
 - If you're about to import the graphic, choose File > Place, select Show Import Options, select and open the file, and then select the Color tab.
- 2 For Profile, choose the source profile to apply to the graphic in your document. If a profile is currently embedded, the profile name appears at the top of the Profile menu.
- 3 (Optional) Choose a rendering intent, and then click OK. In most cases, it's best to use the default rendering intent.

Note: You can also view or change profiles for objects in Acrobat.

See also

[“Convert document colors to another profile \(Photoshop\)”](#) on page 143

Color-managing documents for online viewing

Color-managing documents for online viewing

Color management for online viewing is very different from color management for printed media. With printed media, you have far more control over the appearance of the final document. With online media, your document will appear on a wide range of possibly uncalibrated monitors and video display systems, significantly limiting your control over color consistency.

When you color-manage documents that will be viewed exclusively on the web, Adobe recommends that you use the sRGB color space. sRGB is the default working space for most Adobe color settings, but you can verify that sRGB is selected in the Color Settings dialog box (Photoshop, Illustrator, InDesign) or the Color Management preferences (Acrobat). With the working space set to sRGB, any RGB graphics you create will use sRGB as the color space.

When working with images that have an embedded color profile other than sRGB, you should convert the image's colors to sRGB before you save the image for use on the web. If you want the application to automatically convert the colors to sRGB when you open the image, select Convert To Working Space as the RGB color management policy. (Make sure that your RGB working space is set to sRGB.) In Photoshop and InDesign, you can also manually convert the colors to sRGB using the Edit > Convert To Profile command.

Note: In InDesign, the Convert To Profile command only converts colors for native, not placed, objects in the document.

See also

[“About color working spaces”](#) on page 144

[“Color management policy options”](#) on page 146

Color-managing PDFs for online viewing

When you export PDFs, you can choose to embed profiles. PDFs with embedded profiles reproduce color consistently in Acrobat 4.0 or later running under a properly configured color management system.

Keep in mind that embedding color profiles increases the size of PDFs. RGB profiles are usually small (around 3 KB); however, CMYK profiles can range from 0.5 to 2 MB.

See also

“[Printing with color management](#)” on page 137

Color-managing HTML documents for online viewing

Many web browsers do not support color management. Of the browsers that do support color management, not all instances can be considered color-managed because they may be running on systems where the monitors are not calibrated. In addition, few web pages contain images with embedded profiles. If you manage a highly controlled environment, such as the intranet of a design studio, you may be able to achieve some degree of HTML color management for images by equipping everyone with a browser that supports color management and calibrating all monitors.

You can approximate how colors will look on uncalibrated monitors by using the sRGB color space. However, because color reproduction varies among uncalibrated monitors, you still won't be able to anticipate the true range of potential display variations.

Proofing colors

About soft-proofing colors

In a traditional publishing workflow, you print a hard proof of your document to preview how its colors will look when reproduced on a specific output device. In a color-managed workflow, you can use the precision of color profiles to soft-proof your document directly on the monitor. You can display an on-screen preview of how your document's colors will look when reproduced on a particular output device.

Keep in mind that the reliability of the soft proof depends upon the quality of your monitor, the profiles of your monitor and output devices, and the ambient lighting conditions of your work environment.

Note: A soft proof alone doesn't let you preview how overprinting will look when printed on an offset press. If you work with documents that contain overprinting, turn on *Overprint Preview* to accurately preview overprints in a soft proof. For Acrobat, the *Overprint Preview* option is automatically applied.

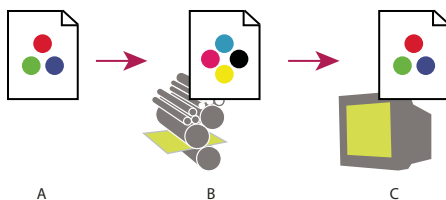

Using a soft proof to preview the final output of a document on your monitor

A. Document is created in its working color space. **B.** Document's color values are translated to color space of chosen proof profile (usually the output device's profile). **C.** Monitor displays proof profile's interpretation of document's color values.

Soft-proof colors

- 1 Choose View > Proof Setup, and do one of the following:
 - Choose a preset that corresponds to the output condition you want to simulate.
 - Choose Custom (Photoshop and InDesign) or Customize (Illustrator) to create a custom proof setup for a specific output condition. This option is recommended for the most accurate preview of your final printed piece.
- 2 Choose View > Proof Colors to toggle the soft-proof display on and off. When soft proofing is on, a check mark appears next to the Proof Colors command, and the name of the proof preset or profile appears at the top of the document window.

 *To compare the colors in the original image and the colors in the soft proof, open the document in a new window before you set up the soft proof.*

Soft-proof presets

Working CMYK Creates a soft proof of colors using the current CMYK working space as defined in the Color Settings dialog box.

Document CMYK (InDesign) Creates a soft proof of colors using the document's CMYK profile.

Working Cyan Plate, Working Magenta Plate, Working Yellow Plate, Working Black Plate, or Working CMY Plates (Photoshop) Creates a soft proof of specific CMYK ink colors using the current CMYK working space.

Macintosh RGB or Windows RGB (Photoshop and Illustrator) Creates a soft proof of colors in an image using either a standard Mac OS or Windows monitor as the proof profile space to simulate. Both options assume that the simulated device will display your document without using color management. Neither option is available for Lab or CMYK documents.

Monitor RGB (Photoshop and Illustrator) Creates a soft proof of colors in an RGB document using your current monitor color space as the proof profile space. This option assumes that the simulated device will display your document without using color management. This option is unavailable for Lab and CMYK documents.

Color Blindness (Photoshop and Illustrator) Creates a soft proof that reflects colors visible to a person with color blindness. The two soft proof options, Protanopia and Deuteranopia, approximate color perception for the most common forms of color blindness. For more information, see "[Soft-proof for color blindness \(Photoshop and Illustrator\)](#)" on page 136.

Custom soft-proof options

Device To Simulate Specifies the color profile of the device for which you want to create the proof. The usefulness of the chosen profile depends on how accurately it describes the device's behavior. Often, custom profiles for specific paper and printer combinations create the most accurate soft proof.

Preserve CMYK Numbers or Preserve RGB Numbers Simulates how the colors will appear without being converted to the color space of the output device. This option is most useful when you are following a safe CMYK workflow.

Rendering Intent (Photoshop and Illustrator) When the Preserve Numbers option is deselected, specifies a rendering intent for converting colors to the device you are trying to simulate.

Use Black Point Compensation (Photoshop) Ensures that the shadow detail in the image is preserved by simulating the full dynamic range of the output device. Select this option if you plan to use black point compensation when printing (which is recommended in most situations).

Simulate Paper Color Simulates the dingy white of real paper, according to the proof profile. Not all profiles support this option.

Simulate Black Ink Simulates the dark gray you really get instead of a solid black on many printers, according to the proof profile. Not all profiles support this option.

 *In Photoshop, if you want the custom proof setup to be the default proof setup for documents, close all document windows before choosing the View > Proof Setup > Custom command.*

Soft-proof for color blindness (Photoshop and Illustrator)

Color Universal Design (CUD) ensures that graphical information is conveyed accurately to people with various types of color vision, including people with color blindness. Several countries have guidelines that require CUD-compliant graphics in public spaces.

The most common types of color blindness are protanopia (reduced sensitivity to red) and deuteranopia (reduced sensitivity to green). A third of color blind people are affected strongly; the remainder have milder forms of color blindness.

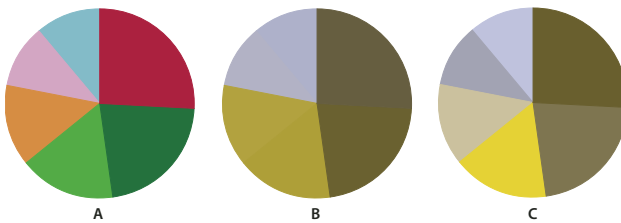

A. Original image B. Color-blind proof C. Optimized design

To determine whether a document is CUD-compliant, do the following:

- 1 Convert the document to RGB color mode, which provides the most accurate soft-proofs for color blindness.
- 2 (Optional) To simultaneously view the original document and a soft-proof, choose Window > New Window (Illustrator) or Window > Arrange > New Window (Photoshop).
- 3 Choose View > Proof Setup > Color Blindness, and then choose either Protanopia-type or Deuteranopia-type. (To comply with CUD, check your document in both views.)

 *In Photoshop, you can print the proof. For more information, search for “Print a hard proof” in Photoshop Help.*

If objects are difficult to distinguish in color blind proofs, adjust the design by doing any of the following:

- Change color brightness or hue:
 - Pure red tends to appear dark and muddy; orange-red is easier to recognize.
 - Bluish green is less confusing than yellowish green.
 - Gray may be confused with magenta, pale pink, pale green, or emerald green.
 - Avoid the following combinations: red and green; yellow and bright green; light blue and pink; dark blue and violet.
 - Avoid red items on dark-colored backgrounds, or white items on yellow or orange-red backgrounds.
- Apply different patterns or shapes.
- Add white, black, or dark-colored borders on color boundaries.
- Use different font families or styles.

Save or load a custom proof setup

- 1 Choose View > Proof Setup > Custom.
- 2 Do either of the following:
 - To save a custom proof setup, click Save. To ensure that the new preset appears in the View > Proof Setup menu, save the preset in the default location.
 - To load a custom proof setup, click Load.

Soft-proof colors (Acrobat)

- 1 Choose Advanced > Print Production > Output Preview.
- 2 Choose the color profile of a specific output device from the Simulation Profile menu.
- 3 Choose a soft-proof option:

Simulate Black Ink Simulates the dark gray you really get instead of a solid black on many printers, according to the proof profile. Not all profiles support this option.

Simulate Paper Color Simulates the dingy white of real paper, according to the proof profile. Not all profiles support this option.

Color-managing documents when printing

Printing with color management

Color management options for printing let you specify how you want Adobe applications to handle the outgoing image data so the printer will print colors consistent with what you see on your monitor. Your options for printing color-managed documents depend on the Adobe application you use, as well as the output device you select. In general, you have the following choices for handling colors during printing:

- Let the printer determine colors.
- Let the application determine colors.
- (Photoshop and InDesign) Do not use color management. In this workflow, no color conversion occurs. You may also need to turn off color management in your printer driver. This method is useful primarily for printing test targets or generating custom profiles.

Letting the printer determine colors when printing

In this workflow, the application does no color conversion, but sends all necessary conversion information to the output device. This method is especially convenient when printing to inkjet photo printers, because each combination of paper type, printing resolution, and additional printing parameters (such as high-speed printing) requires a different profile. Most new inkjet photo printers come with fairly accurate profiles built into the driver, so letting the printer select the right profile saves time and alleviates mistakes. This method is also recommended if you are not familiar with color management.

If you choose this method, it is very important that you set up printing options and turn on color management in your printer driver. Search Help for additional instructions.

If you select a PostScript printer, you can take advantage of *PostScript color management*. PostScript color management makes it possible to perform color composite output or color separations at the raster image processor (RIP)—a process called *in-RIP separations*—so that a program need only specify parameters for separation and let the device calculate the final color values. PostScript color-managed output workflows require an output device that supports PostScript color management using PostScript Level 2 version 2017 or later, or PostScript Language Level 3.

Letting the application determine colors when printing

In this workflow, the application does all the color conversion, generating color data specific to one output device. The application uses the assigned color profiles to convert colors to the output device's gamut, and sends the resulting values to the output device. The accuracy of this method depends on the accuracy of the printer profile you select. Use this workflow when you have custom ICC profiles for each specific printer, ink, and paper combination.

If you choose this option, it is very important that you disable color management in your printer driver. Letting the application and the printer driver simultaneously manage colors during printing results in unpredictable color. Search Help for additional instructions.

Obtaining custom profiles for desktop printers

If the output profiles that come with your printer don't produce satisfactory results, you obtain custom profiles in the following ways:

- Purchase a profile for your type of printer and paper. This is usually the easiest and least expensive method.
- Purchase a profile for your specific printer and paper. This method involves printing a profiling target on your printer and paper, and providing that target to a company that will create a specific profile. This is more expensive than purchasing a standard profile, but can provide better results because it compensates for any manufacturing variations in printers.
- Create your own profile using a scanner-based system. This method involves using profile-creation software and your own flatbed scanner to scan the profiling target. It can provide excellent results for matte surface papers, but not glossy papers. (Glossy papers tend to have fluorescent brighteners in them that look different to a scanner than they do in room light.)
- Create your own profile using a hardware profile-creation tool. This method is expensive but can provide the best results. A good hardware tool can create an accurate profile even with glossy papers.
- Tweak a profile created using one of the previous methods with profile-editing software. This software can be complex to use, but it lets you correct problems with a profile or simply adjust a profile to produce results more to your taste.

See also

[“Install a color profile”](#) on page 141

Color-managing PDFs for printing

When you create Adobe PDFs for commercial printing, you can specify how color information is represented. The easiest way to do this is using a PDF/X standard; however, you can also specify color-handling options manually in the Output section of the PDF dialog box. For more information about PDF/X and how to create PDFs, search Help.

In general, you have the following choices for handling colors when creating PDFs:

- (PDF/X-3) Does not convert colors. Use this method when creating a document that will be printed or displayed on various or unknown devices. When you select a PDF/X-3 standard, color profiles are automatically embedded in the PDF.
- (PDF/X-1a) Converts all colors to the destination CMYK color space. Use this method if you want to create a press-ready file that does not require any further color conversions. When you select a PDF/X-1a standard, no profiles are embedded in the PDF.
- (Illustrator and InDesign) Converts colors that have embedded profiles to the destination color space, but preserves the numbers for those colors without embedded profiles. You can manually select this option in the Output section of the PDF dialog box. Use this method if the document contains CMYK images that aren't color-managed and you want to make sure that the color numbers are preserved.

Note: All spot color information is preserved during color conversion; only the process color equivalents convert to the designated color space.

See also

“[Using a safe CMYK workflow](#)” on page 132

Working with color profiles

About color profiles

Precise, consistent color management requires accurate ICC-compliant profiles of all of your color devices. For example, without an accurate scanner profile, a perfectly scanned image may appear incorrect in another program, simply due to any difference between the scanner and the program displaying the image. This misleading representation may cause you to make unnecessary, time-wasting, and potentially damaging “corrections” to an already satisfactory image. With an accurate profile, a program importing the image can correct for any device differences and display a scan's actual colors.

A color management system uses the following kinds of profiles:

Monitor profiles Describe how the monitor is currently reproducing color. This is the first profile you should create because viewing color accurately on your monitor allows for critical color decisions in the design process. If what you see on your monitor is not representative of the actual colors in your document, you will not be able to maintain color consistency.

Input device profiles Describe what colors an input device is capable of capturing or scanning. If your digital camera offers a choice of profiles, Adobe recommends that you select Adobe RGB. Otherwise, use sRGB (which is the default for most cameras). Advanced users may also consider using different profiles for different light sources. For scanner profiles, some photographers create separate profiles for each type or brand of film scanned on a scanner.

Output device profiles Describe the color space of output devices like desktop printers or a printing press. The color management system uses output device profiles to properly map the colors in a document to the colors within the gamut of an output device's color space. The output profile should also take into consideration specific printing conditions, such as the type of paper and ink. For example, glossy paper is capable of displaying a different range of colors than matte paper.

Most printer drivers come with built-in color profiles. It's a good idea to try these profiles before you invest in custom profiles.

Document profiles Define the specific RGB or CMYK color space of a document. By assigning, or *tagging*, a document with a profile, the application provides a definition of actual color appearances in the document. For example, R=127, G=12, B=107 is just a set of numbers that different devices will display differently. But when tagged with the Adobe RGB color space, these numbers specify an actual color or wavelength of light—in this case, a specific color of purple.

When color management is on, Adobe applications automatically assign new documents a profile based on Working Space options in the Color Settings dialog box. Documents without assigned profiles are known as *untagged* and contain only raw color numbers. When working with untagged documents, Adobe applications use the current working space profile to display and edit colors.

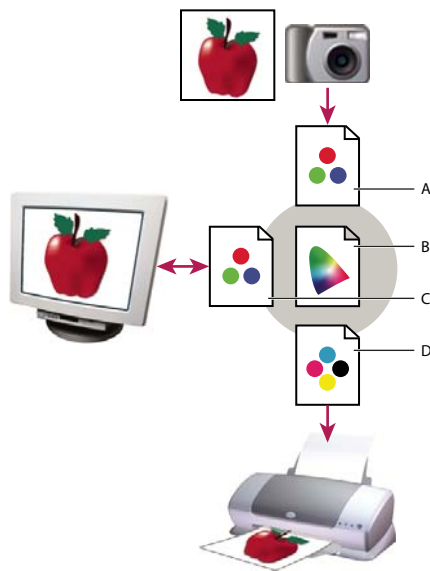

Managing color with profiles

A. Profiles describe the color spaces of the input device and the document. **B.** Using the profiles' descriptions, the color management system identifies the document's actual colors. **C.** The monitor's profile tells the color management system how to translate the document's numeric values to the monitor's color space. **D.** Using the output device's profile, the color management system translates the document's numeric values to the color values of the output device so the correct appearance of colors is printed.

See also

[“Calibrate and profile your monitor”](#) on page 141

[“Letting the printer determine colors when printing”](#) on page 137

[“Obtaining custom profiles for desktop printers”](#) on page 138

[“About color working spaces”](#) on page 144

About monitor calibration and characterization

Profiling software can both calibrate and characterize your monitor. *Calibrating* your monitor brings it into compliance with a predefined standard—for example, adjusting your monitor so that it displays color using the graphics arts standard white point color temperature of 5000° K (Kelvin). *Characterizing* your monitor simply creates a profile that describes how the monitor is currently reproducing color.

Monitor calibration involves adjusting the following video settings:

Brightness and contrast The overall level and range, respectively, of display intensity. These parameters work just as they do on a television. A monitor calibration utility helps you set an optimum brightness and contrast range for calibration.

Gamma The brightness of the midtone values. The values produced by a monitor from black to white are nonlinear—if you graph the values, they form a curve, not a straight line. Gamma defines the value of that curve halfway between black and white.

Phosphors The substances that CRT monitors use to emit light. Different phosphors have different color characteristics.

White point The color and intensity of the brightest white the monitor can reproduce.

Calibrate and profile your monitor

When you calibrate your monitor, you are adjusting it so it conforms to a known specification. Once your monitor is calibrated, the profiling utility lets you save a color profile. The profile describes the color behavior of the monitor—what colors can or cannot be displayed on the monitor and how the numeric color values in an image must be converted so that colors are displayed accurately.

- 1 Make sure your monitor has been turned on for at least a half hour. This gives it sufficient time to warm up and produce more consistent output.
- 2 Make sure your monitor is displaying thousands of colors or more. Ideally, make sure it is displaying millions of colors or 24-bit or higher.
- 3 Remove colorful background patterns on your monitor desktop and set your desktop to display neutral grays. Busy patterns or bright colors surrounding a document interfere with accurate color perception.
- 4 Do one of the following to calibrate and profile your monitor:
 - In Windows, install and use a monitor calibration utility.
 - In Mac OS, use the Calibrate utility, located on the System Preferences/Displays/Color tab.
 - For the best results, use third-party software and measuring devices. In general, using a measuring device such as a colorimeter along with software can create more accurate profiles because an instrument can measure the colors displayed on a monitor far more accurately than the human eye.

Note: Monitor performance changes and declines over time; recalibrate and profile your monitor every month or so. If you find it difficult or impossible to calibrate your monitor to a standard, it may be too old and faded.

Most profiling software automatically assigns the new profile as the default monitor profile. For instructions on how to manually assign the monitor profile, refer to the Help system for your operating system.

Install a color profile

Color profiles are often installed when a device is added to your system. The accuracy of these profiles (often called *generic profiles* or *canned profiles*) varies from manufacturer to manufacturer. You can also obtain device profiles from your service provider, download profiles from the web, or create *custom profiles* using professional profiling equipment.

- In Windows, right-click a profile and select Install Profile. Alternatively, copy the profiles into the `WINDOWS\system32\spool\drivers\color` folder.
- In Mac OS, copy profiles into the `/Library/ColorSync/Profiles` folder or the `/Users/[username]/Library/ColorSync/Profiles` folder.

After installing color profiles, be sure to restart Adobe applications.

See also

“[Obtaining custom profiles for desktop printers](#)” on page 138

Embed a color profile

To embed a color profile in a document you created in Illustrator, InDesign, or Photoshop, you must save or export the document in a format that supports ICC profiles.

- 1 Save or export the document in one of the following file formats: Adobe PDF, PSD (Photoshop), AI (Illustrator), INDD (InDesign), JPEG, Photoshop EPS, Large Document Format, or TIFF.
- 2 Select the option for embedding ICC profiles. The exact name and location of this option varies between applications. Search Adobe Help for additional instructions.

Embed a color profile (Acrobat)

You can embed a color profile in an object or an entire PDF. Acrobat attaches the appropriate profile, as specified in the Convert Colors dialog box, to the selected color space in the PDF. For more information, see the color conversion topics in Acrobat Help.

Changing the color profile for a document

There are very few situations that require you to change the color profile for a document. This is because your application automatically assigns the color profile based on the settings you select in the Color Settings dialog box. The only times you should manually change a color profile are when preparing a document for a different output destination or correcting a policy behavior that you no longer want implemented in the document. Changing the profile is recommended for advanced users only.

You can change the color profile for a document in the following ways:

- Assign a new profile. The color numbers in the document remain the same, but the new profile may dramatically change the appearance of the colors as displayed on your monitor.
- Remove the profile so that the document is no longer color-managed.
- (Acrobat, Photoshop and InDesign) Convert the colors in the document to the color space of a different profile. The color numbers are shifted in an effort to preserve the original color appearances.

Assign or remove a color profile (Illustrator, Photoshop)

- 1 Choose Edit > Assign Profile.
- 2 Select an option, and click OK:

Don't Color Manage This Document Removes the existing profile from the document. Select this option only if you are sure that you do not want to color-manage the document. After you remove the profile from a document, the appearance of colors is defined by the application's working space profiles.

Working [color model: working space] Assigns the working space profile to the document.

Profile Lets you select a different profile. The application assigns the new profile to the document without converting colors to the profile space. This may dramatically change the appearance of the colors as displayed on your monitor.

See also

["Changing the color profile for a document"](#) on page 142

Assign or remove a color profile (InDesign)

- 1 Choose Edit > Assign Profiles.

2 For RGB Profile and CMYK Profile, select one of the following:

Discard (Use Current Working Space) Removes the existing profile from the document. Select this option only if you are sure that you do not want to color-manage the document. After you remove the profile from a document, the appearance of colors is defined by the application's working space profiles, and you can no longer embed a profile in the document.

Assign Current Working Space [working space] Assigns the working space profile to the document.

Assign Profile Lets you select a different profile. The application assigns the new profile to the document without converting colors to the profile space. This may dramatically change the appearance of the colors as displayed on your monitor.

3 Choose a rendering intent for each type of graphic in your document. For each graphic type, you can choose one of the four standard intents, or the Use Color Settings Intent, which uses the rendering intent currently specified in the Color Settings dialog box. For more information on rendering intents, search in Help.

The graphic types include the following:

Solid Color Intent Sets the rendering intent for all vector art (solid areas of color) in InDesign native objects.

Default Image Intent Sets the default rendering intent for bitmap images placed in InDesign. You can still override this setting on an image-by-image basis.

After-Blending Intent Sets the rendering intent to the proofing or final color space for colors that result from transparency interactions on the page. Use this option when your document includes transparent objects.

4 To preview the effects of the new profile assignment in the document, select Preview, and then click OK.

See also

[“Changing the color profile for a document”](#) on page 142

[“View or change profiles for imported bitmap images \(InDesign\)”](#) on page 133

Convert document colors to another profile (Photoshop)

1 Choose Edit > Convert To Profile.

2 Under Destination Space, choose the color profile to which you want to convert the document's colors. The document will be converted to and tagged with this new profile.

3 Under Conversion Options, specify a color management engine, a rendering intent, and black point and dither options (if available). (See [“Color conversion options”](#) on page 147.)

4 To flatten all layers of the document onto a single layer upon conversion, select Flatten Image.

5 To preview the effects of the conversion in the document, select Preview.

See also

[“Changing the color profile for a document”](#) on page 142

Convert document colors to Multichannel, Device Link, or Abstract color profiles (Photoshop)

1 Choose Edit > Convert To Profile.

2 Click Advanced. The following additional ICC profile types are available under Destination Space:

Multichannel Profiles that support more than four color channels. These are useful when printing with more than four inks.

Device Link Profiles that transform from one device color space to another, without using an intermediate color space in the process. These are useful when specific mappings of device values (like 100% black) are required.

Abstract Profiles that enable custom image effects. Abstract profiles can have LAB/XYZ values for both input and output values, which enables generation of a custom LUT to achieve the desired special effect.

Note: Gray, RGB, LAB, and CMYK color profiles are grouped by category in Advanced view. They are combined on the Profile menu in Basic view.

3 To preview the effects of the conversion in the document, select Preview.

See also

[“Changing the color profile for a document”](#) on page 142

Convert document colors to another profile

You convert colors in a PDF using the Convert Colors tool on the Print Production toolbar. For more information, see the color conversion topics in Acrobat Help.

Color settings

Customize color settings

For most color-managed workflows, it is best to use a preset color setting that has been tested by Adobe Systems. Changing specific options is recommended only if you are knowledgeable about color management and very confident about the changes you make.

After you customize options, you can save them as a preset. Saving color settings ensures that you can reuse them and share them with other users or applications.

- To save color settings as a preset, click Save in the Color Settings dialog box. To ensure that the application displays the setting name in the Color Settings dialog box, save the file in the default location. If you save the file to a different location, you must load the file before you can select the setting.
- To load a color settings preset that’s not saved in the standard location, click Load in the Color Settings dialog box, select the file you want to load, and click Open.

Note: In Acrobat, you cannot save customized color settings. To share customized color settings with Acrobat, you must create the file in InDesign, Illustrator, or Photoshop, and then save it in the default Settings folder. It will then be available in the Color Management category of the Preferences dialog box. You can also add settings manually to the default Settings folder.

About color working spaces

A *working space* is an intermediate color space used to define and edit color in Adobe applications. Each color model has a working space profile associated with it. You can choose working space profiles in the Color Settings dialog box.

A working space profile acts as the source profile for newly created documents that use the associated color model. For example, if Adobe RGB (1998) is the current RGB working space profile, each new RGB document that you create will use colors within the Adobe RGB (1998) gamut. Working spaces also determine the appearance of colors in untagged documents.

If you open a document embedded with a color profile that doesn't match the working space profile, the application uses a *color management policy* to determine how to handle the color data. In most cases, the default policy is to preserve the embedded profile.

See also

[“About missing and mismatched color profiles”](#) on page 146

[“Color management policy options”](#) on page 146

Working space options

To display working space options in Photoshop, Illustrator and InDesign, choose Edit > Color Settings. In Acrobat, select the Color Management category of the Preferences dialog box.

 *To view a description of any profile, select the profile and then position the pointer over the profile name. The description appears at the bottom of the dialog box.*

RGB Determines the RGB color space of the application. In general, it's best to choose Adobe RGB or sRGB, rather than the profile for a specific device (such as a monitor profile).

sRGB is recommended when you prepare images for the web, because it defines the color space of the standard monitor used to view images on the web. sRGB is also a good choice when you work with images from consumer-level digital cameras, because most of these cameras use sRGB as their default color space.

Adobe RGB is recommended when you prepare documents for print, because Adobe RGB's gamut includes some printable colors (cyans and blues in particular) that can't be defined using sRGB. Adobe RGB is also a good choice when working with images from professional-level digital cameras, because most of these cameras use Adobe RGB as their default color space.

CMYK Determines the CMYK color space of the application. All CMYK working spaces are device-dependent, meaning that they are based on actual ink and paper combinations. The CMYK working spaces Adobe supplies are based on standard commercial print conditions.

Gray (Photoshop) or Grayscale (Acrobat) Determines the grayscale color space of the application.

Spot (Photoshop) Specifies the dot gain to use when displaying spot color channels and duotones.

***Note:** In Acrobat, you can use the color space in an embedded output intent instead of a document color space for viewing and printing. For more information on output intents, see Acrobat Help.*

Adobe applications ship with a standard set of working space profiles that have been recommended and tested by Adobe Systems for most color management workflows. By default, only these profiles appear in the working space menus. To display additional color profiles that you have installed on your system, select Advanced Mode (Illustrator and InDesign) or More Options (Photoshop). A color profile must be bi-directional (that is, contain specifications for translating both into and out of color spaces) in order to appear in the working space menus.

***Note:** In Photoshop, you can create custom working space profiles. However, Adobe recommends that you use a standard working space profile rather than create a custom profile. For more information, see the Photoshop support knowledgebase at www.adobe.com/support/products/photoshop.html.*

About missing and mismatched color profiles

For a newly created document, the color workflow usually operates seamlessly: Unless specified otherwise, the document uses the working space profile associated with its color mode for creating and editing colors.

However, some existing documents may not use the working space profile that you have specified, and some existing documents may not be color-managed. It is common to encounter the following exceptions to your color-managed workflow:

- You might open a document or import color data (for example, by copying and pasting or dragging and dropping) from a document that is not tagged with a profile. This is often the case when you open a document created in an application that either does not support color management or has color management turned off.
- You might open a document or import color data from a document that is tagged with a profile different from the current working space. This may be the case when you open a document that was created using different color management settings, or scanned and tagged with a scanner profile.

In either case, the application uses a color management policy to decide how to handle the color data in the document.

If the profile is missing or does not match the working space, the application may display a warning message, depending on options you set in the Color Settings dialog box. Profile warnings are turned off by default, but you can turn them on to ensure the appropriate color management of documents on a case-by-case basis. The warning messages vary between applications, but in general you have the following options:

- (Recommended) Leave the document or imported color data as it is. For example, you can choose to use the embedded profile (if one exists), leave the document without a color profile (if one doesn't exist), or preserve the numbers in pasted color data.
- Adjust the document or imported color data. For example, when opening a document with a missing color profile, you can choose to assign the current working space profile or a different profile. When opening a document with a mismatched color profile, you can choose to discard the profile or convert the colors to the current working space. When importing color data, you can choose to convert the colors to the current working space in order to preserve their appearance.

Color management policy options

A *color management policy* determines how the application handles color data when you open a document or import an image. You can choose different policies for RGB and CMYK images, and you can specify when you want warning messages to appear. To display color management policy options, choose Edit > Color Settings.

 *To view a description of a policy, select the policy and then position the pointer over the policy name. The description appears at the bottom of the dialog box.*

RGB, CMYK, And Gray (Gray option is available for Photoshop only.) Specifies a policy to follow when bringing colors into the current working space (either by opening files or importing images into the current document). Choose from the following options:

- **Preserve Embedded Profiles** Always preserves embedded color profiles when opening files. This is the recommended option for most workflows because it provides consistent color management. One exception is if you're concerned about preserving CMYK numbers, in which case you should select Preserve Numbers (Ignore Linked Profiles) instead.
- **Convert To Working Space** Converts colors to the current working space profile when opening files and importing images. Select this option if you want to force all colors to use a single profile (the current working space profile).
- **Preserve Numbers (Ignore Linked Profiles)** This option is available in InDesign and Illustrator for CMYK. Preserves color numbers when opening files and importing images, but still allows you to use color management to

view colors accurately in Adobe applications. Select this option if you want to use a safe CMYK workflow. In InDesign, you can override this policy on a per-object basis by choosing Object > Image Color Settings.

- **Off** Ignores embedded color profiles when opening files and importing images, and does not assign the working space profile to new documents. Select this option if you want to discard any color metadata provided by the original document creator.

Profile Mismatches: Ask When Opening Displays a message whenever you open a document tagged with a profile other than the current working space. You will be given the option to override the policy's default behavior. Select this option if you want to ensure the appropriate color management of documents on a case-by-case basis.

Profile Mismatches: Ask When Pasting Displays a message whenever color profile mismatches occur as colors are imported into a document through pasting or dragging-and-dropping. You will be given the option to override the policy's default behavior. Select this option if you want to ensure the appropriate color management of pasted colors on a case-by-case basis.

Missing Profiles: Ask When Opening Displays a message whenever you open an untagged document. You will be given the option to override the policy's default behavior. Select this option if you want to ensure the appropriate color management of documents on a case-by-case basis.

Color conversion options

Color conversion options let you control how the application handles the colors in a document as it moves from one color space to another. Changing these options is recommended only if you are knowledgeable about color management and very confident about the changes you make. To display conversion options, choose Edit > Color Settings, and select Advanced Mode (Illustrator and InDesign) or More Options (Photoshop). In Acrobat, select the Color Management category of the Preferences dialog box.

Engine Specifies the Color Management Module (CMM) used to map the gamut of one color space to the gamut of another. For most users, the default Adobe (ACE) engine fulfills all conversion needs.

 *To view a description of an engine or intent option, select the option and then position the pointer over the option name. The description appears at the bottom of the dialog box.*

Intent (Photoshop, Illustrator, InDesign) Specifies the rendering intent used to translate one color space to another. Differences between rendering intents are apparent only when you print a document or convert it to a different working space.

Use Black Point Compensation Ensures that the shadow detail in the image is preserved by simulating the full dynamic range of the output device. Select this option if you plan to use black point compensation when printing (which is recommended in most situations).

Use Dither (Photoshop) Controls whether to dither colors when converting 8-bit-per-channel images between color spaces. When the Use Dither option is selected, Photoshop mixes colors in the destination color space to simulate a missing color that existed in the source space. Although dithering helps to reduce the blocky or banded appearance of an image, it may also result in larger file sizes when images are compressed for web use.

Compensate For Scene-Rendered Profiles (Photoshop) Compares video contrast when converting from scene to output profiles. This option reflects default color management in After Effects.

About rendering intents

A *rendering intent* determines how a color management system handles color conversion from one color space to another. Different rendering intents use different rules to determine how the source colors are adjusted; for example, colors that fall inside the destination gamut may remain unchanged, or they may be adjusted to preserve the original range of visual relationships when translated to a smaller destination gamut. The result of choosing a rendering intent depends on the graphical content of documents and on the profiles used to specify color spaces. Some profiles produce identical results for different rendering intents.

 *In general, it is best to use the default rendering intent for the selected color setting, which has been tested by Adobe Systems to meet industry standards. For example, if you choose a color setting for North America or Europe, the default rendering intent is Relative Colorimetric. If you choose a color setting for Japan, the default rendering intent is Perceptual.*

You can select a rendering intent when you set color conversion options for the color management system, soft-proof colors, and print artwork:

Perceptual Aims to preserve the visual relationship between colors so it's perceived as natural to the human eye, even though the color values themselves may change. This intent is suitable for photographic images with lots of out-of-gamut colors. This is the standard rendering intent for the Japanese printing industry.

Saturation Tries to produce vivid colors in an image at the expense of color accuracy. This rendering intent is suitable for business graphics like graphs or charts, where bright saturated colors are more important than the exact relationship between colors.

Relative Colorimetric Compares the extreme highlight of the source color space to that of the destination color space and shifts all colors accordingly. Out-of-gamut colors are shifted to the closest reproducible color in the destination color space. Relative Colorimetric preserves more of the original colors in an image than Perceptual. This is the standard rendering intent for printing in North America and Europe.

Absolute Colorimetric Leaves colors that fall inside the destination gamut unchanged. Out-of-gamut colors are clipped. No scaling of colors to destination white point is performed. This intent aims to maintain color accuracy at the expense of preserving relationships between colors and is suitable for proofing to simulate the output of a particular device. This intent is particularly useful for previewing how paper color affects printed colors.

Advanced controls in Photoshop

In Photoshop you display advanced controls for managing color by choosing Edit > Color Settings and selecting More Options.

Desaturate Monitor Colors By Determines whether to desaturate colors by the specified amount when displayed on the monitor. When selected, this option can aid in visualizing the full range of color spaces with gamuts larger than that of the monitor. However, this causes a mismatch between the monitor display and the output. When the option is deselected, distinct colors in the image may display as a single color.

Blend RGB Colors Using Gamma Controls how RGB colors blend together to produce composite data (for example, when you blend or paint layers using Normal mode). When the option is selected, RGB colors are blended in the color space corresponding to the specified gamma. A gamma of 1.00 is considered "colorimetrically correct" and should result in the fewest edge artifacts. When the option is deselected, RGB colors are blended directly in the document's color space.

Note: *When you select Blend RGB Colors Using Gamma, layered documents will look different when displayed in other applications than they do in Photoshop.*

Chapter 7: Color and tonal adjustments

Photoshop® CS4 provides a comprehensive set of tools for making color and tonal corrections and adjustments.

Viewing histograms and pixel values

About histograms

A *histogram* illustrates how pixels in an image are distributed by graphing the number of pixels at each color intensity level. The histogram shows detail in the shadows (shown in the left part of the histogram), midtones (shown in the middle), and highlights (shown in the right part) A histogram can help you determine whether an image has enough detail to make a good correction.

The histogram also gives a quick picture of the tonal range of the image, or the image *key type*. A low-key image has detail concentrated in the shadows. A high-key image has detail concentrated in the highlights. And, an average-key image has detail concentrated in the midtones. An image with full tonal range has some pixels in all areas. Identifying the tonal range helps determine appropriate tonal corrections.

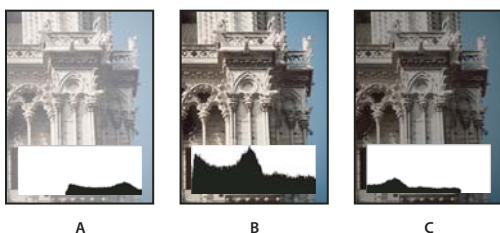

How to read a histogram

A. Overexposed photo B. Properly exposed photo with full tonality C. Underexposed photo

The Histogram panel offers many options for viewing tonal and color information about an image. By default, the histogram displays the tonal range of the entire image. To display histogram data for a portion of the image, first select that portion.

 You can view an image histogram as an overlay in the Curves dialog box by selecting the histogram option under Curve Display Options, and in the Curves Adjustment panel by choosing Curve Display Options from the panel menu, then Histogram.

Histogram panel overview

- ❖ Choose Window > Histogram or click the Histogram tab to open the Histogram panel. By default, the Histogram panel opens in Compact View with no controls or statistics, but you can adjust the view.

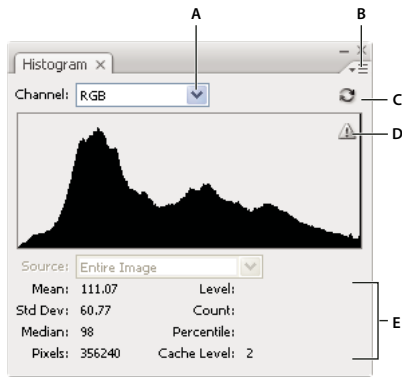

Histogram panel

A. Channel menu B. panel menu C. Uncached Refresh button D. Cached Data Warning icon E. Statistics

Adjust the view of the Histogram panel

❖ Choose a view from the Histogram panel menu.

Expanded View Displays the histogram with statistics. It also displays: controls for choosing the channel represented by the histogram, viewing options in the Histogram panel, refreshing the histogram to display uncached data, and choosing a specific layer in a multilayered document.

Compact View Displays a histogram with no controls or statistics. The histogram represents the entire image.

All Channels View Displays individual histograms of the channels in addition to all the options of the Expanded View. The individual histograms do not include alpha channels, spot channels, or masks.

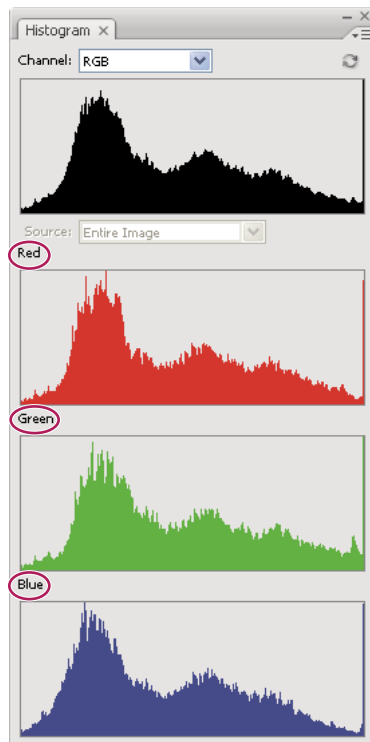

Histogram panel with all channels displayed and statistics hidden

View a specific channel in the histogram

If you chose the Expanded View or All Channels View of the Histogram panel, you can choose a setting from the Channel menu. Photoshop remembers the channel setting if you switch from either Expanded View or All Channels View back to Compact View.

- Choose an individual channel to display a histogram of the channel, including color channels, alpha channels, and spot channels.
- Depending on the color mode of the image, choose RGB, CMYK, or Composite to view a composite histogram of all the channels.
- If the image is RGB or CMYK, choose Luminosity to display a histogram representing the luminance or intensity values of the composite channel.
- If the image is RGB or CMYK, choose Colors to display a composite histogram of the individual color channels in color. This option is the default view for RGB and CMYK images when you first choose Expanded View or All Channels View.

In the All Channels View, choosing from the Channels menu affects only the topmost histogram in the panel.

View channel histograms in color

❖ From the Histogram panel, do one of the following:

- In the All Channels View, choose Show Channels In Color from the panel menu.
- In Expanded View or All Channels View, choose an individual channel from the Channel menu and choose Show Channels In Color from the panel menu. If you switch to Compact View, the channel continues to be shown in color.
- In Expanded View or All Channels View, choose Colors from the Channel menu to show a composite histogram of the channels in color. If you switch to Compact View, the composite histogram continues to be shown in color.

View histogram statistics

By default, the Histogram panel displays statistics in the Expanded View and All Channels View.

1 Choose Show Statistics from the Histogram panel menu.

2 Do one of the following:

- To view information about a specific pixel value, place the pointer in the histogram.
- To view information about a range of values, drag in the histogram to highlight the range.

The panel displays the following statistical information below the histogram:

Mean Represents the average intensity value.

Std Dev (Standard deviation) Represents how widely intensity values vary.

Median Shows the middle value in the range of intensity values.

Pixels Represents the total number of pixels used to calculate the histogram.

Level Displays the intensity level of the area underneath the pointer.

Count Shows the total number of pixels corresponding to the intensity level underneath the pointer.

Percentile Displays the cumulative number of pixels at or below the level underneath the pointer. This value is expressed as a percentage of all the pixels in the image, from 0% at the far left to 100% at the far right.

Cache Level Shows the current image cache used to create the histogram. When the cache level is higher than 1, the histogram is displayed faster. In this case, the histogram is derived from a representative sampling of pixels in the image (based on the magnification). The original image is cache level 1. At each level above level 1, four adjacent pixels are averaged to arrive at a single pixel value. So, each level is half the dimensions (has 1/4 the number of pixels) of the lower level. When Photoshop makes a quick approximation, it can use one of the upper levels. Click the Uncached Refresh button to redraw the histogram using the actual image layer.

View the histogram for a multilayered document

- 1 Choose Expanded View from the Histogram panel menu.
- 2 Choose a setting from the Source menu. (The Source menu is not available for single-layered documents.)

Entire Image Displays a histogram of the entire image, including all layers.

Selected Layer Displays a histogram of the layer that's selected in the Layers panel.

Adjustment Composite Displays a histogram of an adjustment layer selected in the Layers panel, including all the layers below the adjustment layer.

Preview histogram adjustments

You can preview the effect on the histogram of any color and tonal adjustments.

- ❖ Select the Preview option in the dialog boxes of any color or tonal adjustment command.

When Preview is selected, the Histogram panel shows how the adjustment affects the histogram.

Note: When making adjustments using the Adjustments panel, changes are automatically reflected in the Histogram panel.

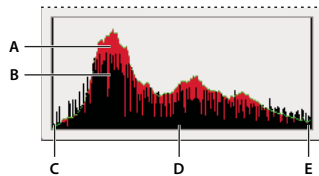



Preview of histogram adjustment in the Histogram panel

A. Original histogram B. Adjusted histogram C. Shadows D. Midtones E. Highlights

Refresh the histogram display

When a histogram is read from a cache instead of the current state of the document, the Cached Data Warning icon  appears in the Histogram panel. Histograms based on the image cache are displayed faster and are based on a representative sampling of pixels in the image. You can set the maximum *cache level* (from 2 to 8) in the Performance preference.

Note: A higher cache level setting will increase the redraw speed for large, multi-layer files, but requires additional usage of system RAM. If RAM is limited or you work mainly with smaller images, use lower cache level settings

- ❖ To refresh the histogram so that it displays all of the pixels of the original image in its current state, do one of the following:
 - Double-click anywhere in the histogram.
 - Click the Cached Data Warning icon .
 - Click the Uncached Refresh button .

- Choose Uncached Refresh from the Histogram panel menu.

For information about cache level, see “Histogram panel overview” on page 149.

View color values in an image

You can use the Info panel to see the color value of pixels as you make color corrections. When you work with a color adjustment dialog box or Adjustments panel, the Info panel displays two sets of color values for the pixels under the pointer. The value in the left column is the original color value. The value in the right column is the color value after the adjustment is made.

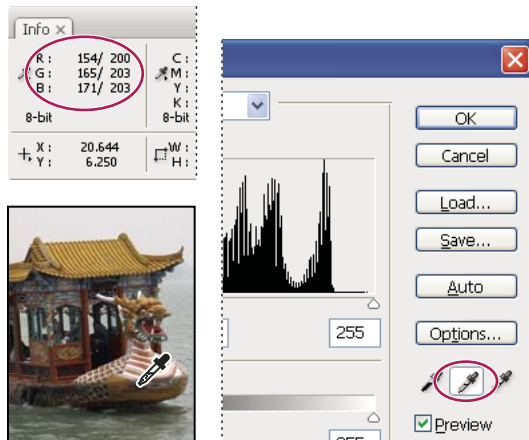

Using Levels and Info panel to neutralize the tone of an image

You can view the color of a single location using the Eyedropper tool . You can also use up to four Color Samplers to display color information for one or more locations in the image. These samplers are saved in the image, so you can refer to them repeatedly as you work, even if you close and reopen the image.

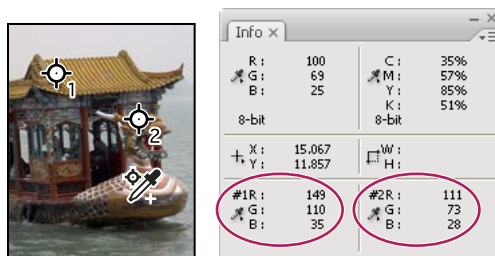



Color samplers and Info panel

- 1 Choose Window > Info to open the Info panel.
- 2 Select (then Shift-click) the Eyedropper tool or Color Sampler tool , and if necessary, choose a sample size in the options bar. Point Sample reads the value of a single pixel, other options read the average of a pixel area.
- 3 If you selected the Color Sampler tool , place up to four color samplers on the image. Click where you want to place a sampler.

View color information while adjusting color

You can view color information for specific pixels in the image while adjusting color with an adjustment dialog box or the Adjustments panel.

- 1 Open an adjustment dialog box (under Image > Adjustments) or add an adjustment using the Adjustments panel.
- 2 As you make adjustments, view the before and after color values in the Info panel. Move the pointer over the image to view color values at the pointer location.

Note: If you are using an adjustment dialog box, the Eyedropper tool  is activated (and other tools temporarily disabled) when you move the pointer over the image. You still have access to the scroll controls and to the Hand and Zoom  tools using keyboard shortcuts.

- 3 If you've placed color samplers on the image, the color values under the color samplers appear in the lower half of the Info panel. To add new color samplers, do one of the following:
 - If using the Adjustments panel, select the Color Sampler tool and click in the image, or select the Eyedropper tool and Shift-click in the image.
 - If using an adjustment dialog, Shift-click in the image.

Adjusting color samplers

Once you've added a color sampler, you can move or delete it, hide it, or change the color sampler information displayed in the Info panel.

Move or delete a color sampler

- 1 Select the Color Sampler tool .
- 2 Do one of the following:
 - To move a color sampler, drag the sampler to the new location.
 - To delete a color sampler, drag the sampler out of the document window. Alternatively, hold down Alt (Windows) or Option (Mac OS) until the pointer becomes a scissors and click the sampler.
 - To delete all color samplers, click Clear in the options bar.
 - To delete a color sampler while an adjustment dialog box is open, hold down Alt+Shift (Windows) or Option+Shift (Mac OS), and click the sampler.

Hide or show color samplers in an image

- ❖ Choose View > Extras. A check mark indicates that color samplers are visible.

Change the display of color sampler information in the Info panel

- To display or hide color sampler information in the Info panel, choose Color Samplers from the panel menu. A check mark indicates that the color sampler information is visible.
- To change the color space in which a color sampler displays values, move the pointer onto the color sampler icon  in the Info panel. Then, hold down the mouse button, and choose another color space from the menu.

Understanding color adjustments

Before making color and tonal adjustments

The powerful tools in Photoshop can enhance, repair, and correct the color and tonality (lightness, darkness, and contrast) in an image. Here are some items to consider before making color and tonal adjustments.

- Work with a monitor that's calibrated and profiled. For critical image editing, calibration and profiling is essential. Otherwise, the image you see on your monitor looks different on other monitors or when printed.
- Plan to use adjustment layers to adjust the tonal range and color balance of your image. Adjustment layers let you go back and make successive tonal adjustments without discarding or permanently modifying data from the image layer. Keep in mind that using adjustment layers adds to the file size of the image and demands more RAM from your computer. Accessing the color and tonal commands in the Adjustments panel automatically creates adjustment layers.
- If you don't want to use adjustment layers, you can apply adjustments directly to an image layer. Remember that some image information is discarded, when making a color or tonal adjustment directly to an image layer.
- For critical work and maximum preservation of image data, it's best if the image you work with is 16 bits per channel (16-bit image) rather than 8 bits per channel (8-bit image). Data is discarded when you make tonal and color adjustments. The loss of image information is more critical in an 8-bit image than a 16-bit image. Generally, 16-bit images have a larger file size than 8-bit images.
- Duplicate or make a copy of the image file. Working on a copy of your image preserves the original in the event you want to use the image in its original state.
- Remove any flaws such as dust spots, blemishes, and scratches from the image before making color and tonal adjustments.
- Open the Info or Histogram panel in Expanded view. As you evaluate and correct the image, both panels display invaluable feedback on your adjustments.
- You can make a selection or use a mask to confine your color and tonal adjustments to part of an image. Another way to apply color and tonal adjustments selectively is to set up your document with image components on different layers. Color and tonal adjustments are applied to only one layer at a time. Only the image components on the targeted layer are affected.

Correcting images

Here is the general workflow you follow when you correct the tonality and color of an image:

- 1 Use the histogram to check the quality and tonal range of the image.
- 2 Make sure that the Adjustments panel is open to access color and tonal adjustments. Click an icon to access the adjustments described in the following steps. Applying corrections from the Adjustments panel creates an adjustment layer, which gives you more flexibility and doesn't discard image information. See "[Adjustments panel overview](#)" on page 156 and "[About adjustment layers and fill layers](#)" on page 307.
- 3 Adjust the color balance to remove unwanted color casts or to correct oversaturated or undersaturated colors. See "[Color adjustment commands](#)" on page 158.
- 4 Adjust the tonal range, using either the Levels or Curves adjustments.

Begin tonal corrections by adjusting the values of the extreme highlight and shadow pixels in the image, setting an overall tonal range for the image. This process is known as *setting the highlights and shadows* or *setting the white and black points*. Setting the highlights and shadows typically redistributes the midtone pixels appropriately. However, you might need to adjust your midtones manually.

To adjust the tonality in just shadow and highlight areas, use the Shadow/Highlight command. See “[Improve shadow and highlight detail](#)” on page 172.

5 (Optional) Make other color adjustments.

After you correct the overall color balance of your image, you can make optional adjustments to enhance colors or produce special effects.

6 Sharpen the edges in the image.

As one of the final steps, use the Unsharp Mask or the Smart Sharpen filter to sharpen the clarity of edges in the image. The amount of sharpening required for an image varies according to the image quality produced by the digital camera or scanner you use. See “[Sharpen images](#)” on page 209.

7 (Optional) Target the image for printer or press characteristics.

You can use options in the Levels or Curves adjustments to import highlight and shadow information into the gamut of an output device, like a desktop printer. This procedure can also be done if you are sending your image to a printing press, and know the characteristics of the press.

Because sharpening increases the contrast of neighboring pixels, it’s possible that some pixels in critical areas might become unprintable on the printer or press that you’re using. For this reason, it’s best to fine-tune the output settings after sharpening. For more information on adjusting the output settings, see “[Setting highlight and shadow target values](#)” on page 175.

For videos on making tonal and lighting corrections, see www.adobe.com/go/vid0009, www.adobe.com/go/vid0010, and www.adobe.com/go/lrvid4121_ps.

Adjustments panel overview

The tools for making color and tonal adjustments can be found in the Adjustments panel. Clicking a tool icon both selects an adjustment and automatically creates an adjustment layer. The adjustments you make using the controls and options in the Adjustments panel create nondestructive adjustment layers. See “[About adjustment layers and fill layers](#)” on page 307.

For your convenience, the Adjustments panel has a list of adjustment presets that apply common image corrections. Presets are available for Levels, Curves, Exposure, Hue/Saturation, Black & White, Channel Mixer, and Selective Color. Clicking a preset applies it to the image using an adjustment layer. You can always save adjustment settings as a preset, which is added to the presets list.



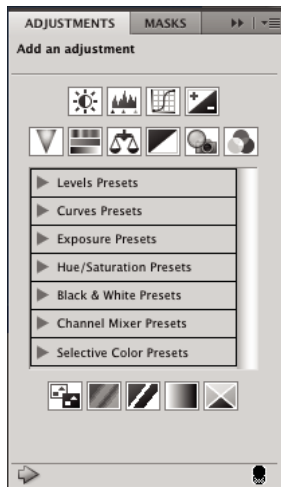

Clicking an adjustment icon or a preset displays the settings options for the specific adjustment.



The Adjustments panel

For a video on the Adjustments panel, see www.adobe.com/go/lrvid4002_ps.

Apply a correction using the Adjustments panel

- 1 In the Adjustments panel, click an adjustment icon or an adjustment preset, or choose an adjustment from the panel menu.
- 2 If necessary, use the controls and options in the Adjustments panel to apply the settings you want.
- 3 (Optional) Do any of the following:
 - To toggle the visibility of the adjustment, click the Toggle Layer Visibility button .
 - To return the adjustment to its original settings, click the Reset button .
 - To discard an adjustment, click the Delete This Adjustment Layer button .
 - To add another adjustment layer above the current one, click the arrow . This procedure returns the Adjustments panel to the display of adjustment icons and presets list.
 - To return to the current adjustments settings options from the adjustment icons and presets in the Adjustments panel, click the arrow .
 - To expand the width of the Adjustment panel, click the Expand View button.

Apply a correction to only the layer below

- 1 In the Adjustments panel, click an adjustment icon or an adjustment preset, or choose an adjustment from the panel menu.
- 2 In the Adjustments panel, click the Clip to Layer button . Click the icon again to make the adjustment apply to all layers below it in the Layers panel.

Save and apply presets using the Adjustments panel

The Adjustments panel has a list of presets for common color and tonal adjustments. In addition, you can save and apply presets for Levels, Curves, Exposure, Hue/Saturation, Black & White, Channel Mixer, and Selective Color. When you save a preset, it's added to the presets list.

- To save adjustment settings as a preset, choose the Save Preset option from the Adjustments panel menu.

- To apply an adjustment preset, click the triangle to expand the list of presets for a specific adjustment and then click a preset. Alt-click (Windows) or Option-click (Mac OS) a triangle to expand all presets.

Color adjustment commands

You can choose from the following color adjustment commands:

Adjust Levels Auto Quickly corrects the color balance in an image. Although its name implies an automatic adjustment, you can fine-tune how the Auto Color command behaves. See “[Remove a color cast using Auto Color](#)” on page 186.

Levels command Adjusts color balance by setting the pixel distribution for individual color channels. See “[Adjust color using Levels](#)” on page 163.

Curves command Provides up to 14 control points for highlight, midtone, and shadow adjustments for individual channels. See “[Curves overview](#)” on page 163.

Exposure command Adjusts tonality by performing calculations in a linear color space. Exposure is primarily for use in HDR images. See “[Adjust Exposure for HDR images](#)” on page 174.

Vibrance command Adjusts color saturation so clipping is minimized. See “[Adjust color saturation using Vibrance](#)” on page 171.

Photo Filter command Makes color adjustments by simulating the effects of using a Kodak Wratten or Fuji filter in front of a camera lens. See “[Change the color balance using the Photo Filter command](#)” on page 183.

Color Balance command Changes the overall mixture of colors in an image. See “[Apply the Color Balance adjustment](#)” on page 184.

Hue/Saturation command Adjusts the hue, saturation, and lightness values of the entire image or of individual color components. See “[Adjust hue and saturation](#)” on page 168.

Match Color command Matches the color: from one photo to another photo, from one layer to another layer, and from a selection in an image to another selection in the same image or a different image. This command also adjusts the luminance and color range and neutralizes color casts in an image. See “[Match the color in different images](#)” on page 177.

Replace Color command Replaces specified colors in an image with new color values. See “[Replace the color of objects in an image](#)” on page 180.

Selective Color command Adjusts the amount of process colors in individual color components. See “[Make selective color adjustments](#)” on page 183.

Channel Mixer command Modifies a color channel and makes color adjustments not easily done with other color adjustment tools. See “[Mix color channels](#)” on page 181.

Make a color adjustment

All Photoshop color adjustment tools work essentially the same way; they map an existing range of pixel values to a new range of values. The difference between the tools is the amount of control they provide. Color adjustment tools and their option settings are accessed in the Adjustments panel. For an overview of the color adjustment tools, see “[Color adjustment commands](#)” on page 158.



You can adjust the color in an image in different ways. The most flexible method is to use an adjustment layer. When you select a color adjustment tool in the Adjustments panel, Photoshop automatically creates an adjustment layer. Adjustment layers let you experiment with color and tonal adjustments without permanently modifying the pixels in the image. The color and tonal changes reside within the adjustment layer, which acts as a veil through which the underlying image layers appear.

- 1 If you want to make adjustments to a portion of your image, select that portion. If you make no selection, the adjustment is applied to the entire image.
- 2 Do one of the following:
 - Click an adjustment icon or select an adjustment preset in the Adjustments panel.
 - Create an adjustment layer. See “[Create adjustment and fill layers](#)” on page 308.
 - Double-click the thumbnail of an existing adjustment layer in the Layers panel.

Note: You can also choose *Image > Adjustments*, and choose a command from the submenu to apply adjustments directly to the image layer. Keep in mind that this method discards image information.

A new adjustment layer includes a layer mask, which by default is empty (or white), meaning that your adjustment is applied to the entire image. (If you have an active selection on the image when you add an adjustment layer, the initial layer mask masks out the unselected area in black.) Using the Brush tool, you can paint black areas on the mask where you don’t want the adjustment to affect the image. See “[Edit a layer mask](#)” on page 321.

- 3 To toggle the view of your image with and without adjustments, click the Toggle Layer Visibility icon  in the Adjustments panel.

 To cancel changes, click the Reset button  in the Adjustments panel.

Save adjustment settings

You can save your color adjustment settings and apply them to other images. Once a setting is saved, it can be accessed in either the presets list of Adjustments panel. You can also choose the Load Preset option from an adjustment dialog box menu. If you are saving color adjustment settings using the Match Color command, see “[Match the color in different images](#)” on page 177.

- To save a setting in the Adjustments panel, choose the Save Preset option from the panel menu. This option is only available for Levels, Curves, Exposure, Hue/Saturation, Black & White, Channel Mixer, and Selective Color.
- To save a setting in the Shadows/Highlights, Variations, or Replace Color image adjustment dialog box, click Save. In the Levels, Curves, Exposure, Hue/Saturation, Black & White, Channel Mixer, or Selective Color image adjustment dialog box, choose Save Preset from the panel menu. Enter a name for the setting, then click Save.

Reapply adjustment settings

Once an adjustment setting is saved, it’s stored as a preset and can be reapplied.

- In the Adjustments panel, expand a set of adjustment presets and select from the menu list.
- In an adjustment dialog box, click Load. Locate and load the saved adjustment file. In the Curves, Black & White, Exposure, Hue/Saturation, Selective Color, Levels, or Channel Mixer dialog boxes, saved presets appear in the Presets menu. Choose Load Preset from the Preset option to load a preset not shown on the Preset pop-up menu from a different location.

To remove default presets, navigate to the following folders, move the presets out of the folders, and restart Photoshop.

- Windows: [startup drive]/Program Files/Adobe/Adobe Photoshop CS4/Presets/[adjustment type]/[preset name]

- Mac OS: [startup drive]/Applications/Adobe Photoshop CS4/Presets/[adjustment type]/[preset name]

Correcting Colors in CMYK and RGB

Although you can perform all color and tonal corrections in RGB mode and most adjustments in CMYK mode, choose a mode carefully. Avoid multiple conversions between modes, because color values are rounded and lost with each conversion. Don't convert RGB images to CMYK mode if they are meant for on-screen display. For CMYK images that are separated and printed, do not make color corrections in RGB mode.

If you must convert your image from one mode to another, perform most of your tonal and color corrections in RGB mode. You can then use CMYK mode for fine-tuning. The advantages of working in RGB mode are:

- RGB has fewer channels. As a result, your computer uses less memory.
- RGB has a wider range of colors than CMYK, and more colors are likely to be preserved after adjustments.

You can soft proof colors to see an on-screen preview of how your document's colors will look when reproduced on a particular output device. See "[About soft-proofing colors](#)" on page 134.

 You can edit an image in RGB mode in one window and view the same image in CMYK colors in another window. Choose **Window > Arrange > New Window For (Filename)** to open a second window. Select the **Working CMYK** option for **Proof Setup**, then choose the **Proof Color** command to turn on the CMYK preview in one of the windows.

Identify out-of-gamut colors

A *gamut* is the range of colors that a color system can display or print. A color that can be displayed in RGB could be *out of gamut*, and therefore unprintable, for your CMYK setting.

In RGB mode, you can tell whether a color is out of gamut in the following ways:

- In the Info panel, an exclamation point appears next to the CMYK values whenever you move the pointer over an out-of-gamut color.
- In both the Color Picker and the Color panel, an alert triangle  appears. When you select an out-of-gamut color, the closest CMYK equivalent is displayed. To select the CMYK equivalent, click the triangle or the color patch.

Photoshop automatically brings all colors into gamut when you convert an RGB image to CMYK. Note that some detail in the image may be lost, depending on your conversion options. You can identify the out-of-gamut colors in an image or correct them manually before converting to CMYK. You can use the **Gamut Warning** command to highlight out-of-gamut colors.

Find out-of-gamut colors

- 1 Choose **View > Proof Setup**, then choose the proof profile on which you want to base the gamut warning.
- 2 Choose **View > Gamut Warning**.

All pixels outside the gamut of the current proof profile space are highlighted in gray.

Change the gamut warning color

- 1 Do one of the following:
 - (Windows) Choose **Edit > Preferences > Transparency & Gamut**.
 - (Mac OS) Choose **Photoshop > Preferences > Transparency & Gamut**.
- 2 Under **Gamut Warning**, click the color box to display the Color Picker. Then choose a new warning color, and click **OK**.

For best results, use a color that is not already present in the image.

3 Enter a value in the Opacity box, then click OK.

Use this option to reveal more or less of the underlying image through the warning color. Values can range from 1 % to 100%.



Original image, and out-of-gamut colors preview with blue selected for gamut warning color

Adjusting image color and tone

Levels overview

You use the Levels adjustment to correct the tonal range and color balance of an image by adjusting intensity levels of image shadows, midtones, and highlights. The Levels histogram is a visual guide for adjusting the image key tones. For more information on how to read a histogram, see “[About histograms](#)” on page 149.

You can save Levels settings as a preset, then apply them to other images. See “[Save adjustment settings](#)” on page 159 and “[Reapply adjustment settings](#)” on page 159.

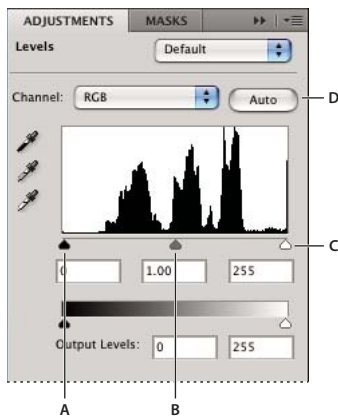

Levels dialog box

A. Shadows B. Midtones C. Highlights D. Apply Auto Color Correction

Adjust tonal range using Levels

The outer two Input Levels sliders map the black point and white point to the settings of the Output sliders. By default, the Output sliders are at level 0, where the pixels are black, and level 255, where the pixels are white. With the Output sliders in the default positions, moving the black input slider maps the pixel value to level 0 and moving the white point slider maps the pixel value to level 255. The remaining levels are redistributed between levels 0 and 255. This redistribution increases the tonal range of the image, in effect increasing the overall contrast of the image.

Note: When shadows are clipped, the pixels are black, with no detail. When highlights are clipped, the pixels are white, with no detail.

The middle Input slider adjusts the gamma in the image. It moves the midtone (level 128) and changes the intensity values of the middle range of gray tones without dramatically altering the highlights and shadows.

1 Do one of the following:

- Click the Levels icon  or a Levels preset in the Adjustments panel, or choose Levels from the panel menu.
- Choose Layer > New Adjustment Layer > Levels. Click OK in the New Layer dialog box.
- Choose Image > Adjustments > Levels.

Note: Choosing Image > Adjustments > Levels makes direct adjustments to the image layer and discards image information.

2 (Optional) To adjust tones for a specific color channel, choose an option from the Channel menu.

3 (Optional) To edit a combination of color channels at the same time, Shift-select the channels in the Channels panel before choosing the Levels command. The Channel menu then displays the abbreviations for the target channels—for example, CM for cyan and magenta. The menu also contains the individual channels for the selected combination. Edit spot channels and alpha channels individually.

Note: This method does not work in a Levels adjustment layer.

4 To adjust the shadows and highlights manually, drag the black and white Input Levels sliders to the edge of the first group of pixels at either end of the histogram.

For example, if you move the black point slider to the right at level 5, Photoshop maps all the pixels at level 5 and lower to level 0. Similarly, if you move the white point slider to the left at level 243, Photoshop maps all pixels at level 243 and higher to level 255. The mapping affects the darkest and lightest pixels in each channel. The corresponding pixels in the other channels are adjusted proportionately to avoid altering the color balance.

Note: You can also enter values directly into the first and third Input Levels text boxes.



Adjusting black and white points with Levels Input sliders

5 (Optional) To identify areas in the image that are being clipped (completely black or completely white), do one of the following:

- Hold down Alt (Windows) or Option (Mac OS) as you drag the black point and white point sliders.
- Choose Show Clipping For Black/White Points from the panel menu.

6 To adjust midtones, use the middle Input slider to make a gamma adjustment.

Moving the middle Input slider to the left makes the overall image lighter. This slider adjustment maps a lower (darker) level up to the midpoint level between the Output sliders. If the Output sliders are in their default position (0 and 255), the midpoint is level 128. In this example, the shadows expand to fill the tonal range from 0 to 128, and the highlights are compressed. Moving the middle Input slider to the right has the opposite effect, making the image darker.

Note: You can also enter a gamma adjustment value directly in the middle Input Levels box.

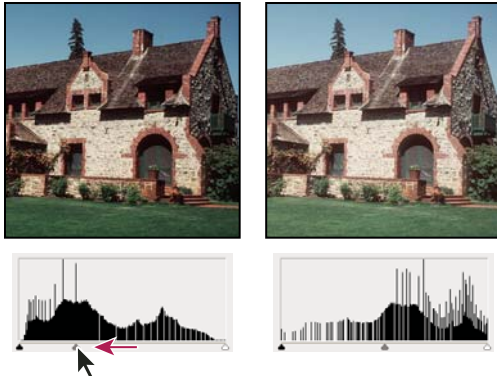

Moving the middle slider adjusts the image gamma

You can view the adjusted histogram in the Histogram panel.

Adjust color using Levels

1 Do one of the following to access the Levels adjustment:

- In the Adjustments panel, click the Levels icon  or a Levels preset, or choose Levels from the panel menu.
- Choose Layer > New Adjustment Layer > Levels. Click OK in the New Layer dialog box.

Note: You can also choose Image > Adjustments > Levels. But keep in mind that this method makes direct adjustments to the image layer and discards image information. Settings are adjusted in the Levels dialog box.

2 In the Adjustments panel, do one of the following to neutralize a color cast:

- Click the Set Gray Point Eyedropper tool . Then click in a part of the image that is neutral gray.
- Click Auto to apply the default automatic levels adjustment. To experiment with other automatic adjustment options, choose Auto Options from the Adjustments panel menu, then change Algorithms in the Auto Color Corrections Options dialog box.

In general, assign equal color component values to achieve a neutral gray. For example, assign equal red, green, and blue values to produce a neutral gray in an RGB image.

Curves overview

You can use Curves or Levels to adjust the entire tonal range of an image. The Curves adjustment lets you adjust points throughout the tonal range of an image (from shadows to highlights). Levels have only three adjustments (white point, black point, gamma). You can also use Curves to make precise adjustments to individual color channels in an image. You can save Curves adjustment settings as presets. See “[Save adjustment settings](#)” on page 159 and “[Reapply adjustment settings](#)” on page 159.

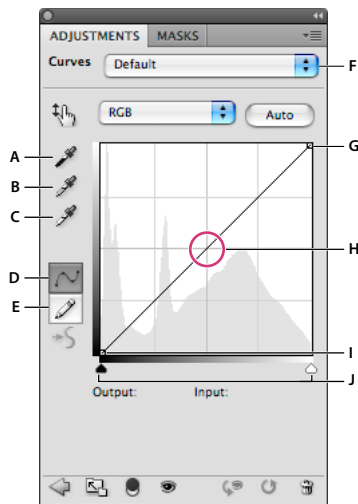

Curves dialog box

A. Sample in image to set black point. B. Sample in image to set gray point. C. Sample in image to set white point. D. Edit points to modify the curve. E. Draw to modify the curve. F. Curves type drop-down menu. G. Set black point. H. Set gray point. I. Set white point. J. Show clipping.

In the Curves adjustment, the tonal range is represented as a straight diagonal baseline, because the input levels (the original intensity values of the pixels) and output levels (new color values) are identical.

Note: After you've made an adjustment to the tonal range in the Curves dialog box, Photoshop continues to display the baseline as a reference. To hide the baseline, turn off Show Baseline in the Curve Grid Options.

The horizontal axis of the graph represents the input levels; the vertical axis represents the output levels.

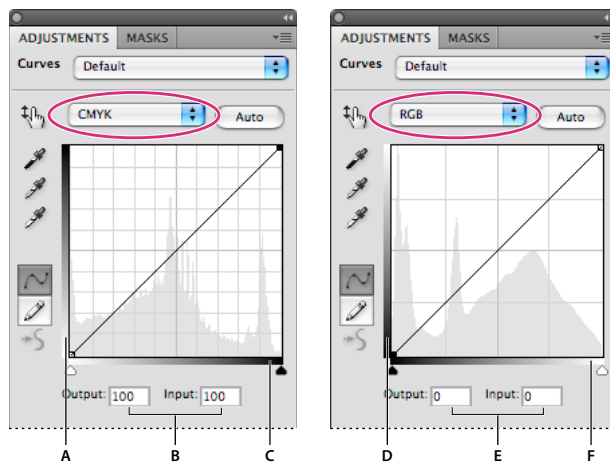

Default Curves dialog boxes for CMYK and RGB images

A. Default orientation of CMYK tonal output bar B. CMYK Input and Output values in percentages C. Default orientation of CMYK tonal input bar D. Default orientation of RGB tonal output bar E. RGB Input and Output values in intensity levels F. Default orientation of RGB tonal input bar

Set Curve display options

You can control the curve grid display using the Curve display options.

1 Do one of the following:

- Click the Curves icon  or a Curves preset in the Adjustments panel, or choose Curves from the panel menu.

- Choose Layer > New Adjustment Layer > Curves. Click OK in the New Layer dialog box.
- Choose Image > Adjustments > Curves.

Note: Choosing Image > Adjustments > Curves applies the adjustment directly to the image layer and discards image information.

2 In the Adjustments panel, choose Curve Display Options from the panel menu.

Note: If you chose Image > Adjustments > Curves, expand the Curve Display Options in the Curves dialog box.

3 Choose any of the following:

- To reverse the display of intensity values and percentages, choose Show Amount Of Light (0-255) or Show Amount Of Pigment/Ink %. Curves displays the intensity values for RGB images in a range from 0 to 255, with black (0) at the lower-left corner. Percentages for CMYK images are displayed in a range from 0 to 100, with highlights (0%) at the lower-left corner. After the intensity values and percentages are reversed, 0 is at the lower-right corner for RGB images; 0% is at the lower-right corner for CMYK images.
- To display gridlines in 25% increments, select Simple Grid; to display in 10% increments, choose Detailed Grid.

 To change the gridline increment, Alt-click (Windows) or Option-click (Mac OS) the grid.

- To display color channel curves superimposed on the composite curve, choose Show Channel Overlays.
- To display a histogram overlay, choose Show Histogram. For more information on how to read a histogram, see “[About histograms](#)” on page 149.
- To display a baseline drawn on the grid at a 45-degree angle, choose Show Baseline.
- To display horizontal and vertical lines to help you align points as you drag relative to the histogram or grid, choose Show Intersection Line.

Adjust color and tonality with Curves

You can adjust the tonality and color of an image by changing the shape of the curve in the Curves adjustment. Moving the curve upward or downward lightens or darkens the image, depending on whether the dialog box is set to display levels or percentages. The steeper sections of the curve represent areas of higher contrast; flatter sections represent areas of lower contrast.

If the Curves adjustment is set to display levels rather than percentages, the highlights are represented in the upper-right corner of the graph. Moving a point in the top portion of the curve adjusts the highlights. Moving a point in the center of the curve adjusts the midtones, and moving a point in the bottom section of the curve adjusts the shadows. To darken highlights, move a point near the top of the curve downward. Moving a point either down or to the right maps the Input value to a lower Output value, and the image darkens. To lighten the shadows, move a point near the bottom of the curve upward. Moving a point either up or to the left maps a lower Input value to a higher Output value, and the image lightens.

Note: In general, only small curve adjustments are necessary to make tonal and color corrections to most images.

1 Do one of the following:

- Click the Curves icon  or a Curves preset in the Adjustments panel.
- Choose Layer > New Adjustment Layer > Curves. Click OK in the New Layer dialog box.

Note: You can also choose Image > Adjustments > Curves. But keep in mind that this method makes direct adjustments to the image layer and discards image information.

- 2 (Optional) To adjust the color balance of the image, choose the channel or channels that you want to adjust from the Channel menu.
- 3 (Optional) To edit a combination of color channels at the same time, Shift-click the channels in the Channels panel before choosing Curves. The Channel menu then displays the abbreviations for the target channels—for example, CM for cyan and magenta. It also contains the individual channels for the selected combination. This method does not work in a Curves adjustment layer.

Note: select *Channel Overlays* in *Curve Display Options* to see the color channel curves superimposed on the composite curve.

4 Add a point along the curve by doing one of the following:

- Click directly on the curve.
- Select the On-image adjustment tool , then click the area in the image that you want to adjust. Drag the pointer up or down to lighten or darken the values for all similar tones in the photo.

 To identify areas in the image that are being clipped (black or white), select *Show Clipping* in the *Curves* dialog box or *Show Clipping For Black/White Points* from the *Adjustments* panel menu.

You can add up to 14 control points to the curve. To remove a control point, drag it off the graph, select it and press Delete, or Ctrl-click (Windows) or Command-click (Mac OS) it. You cannot delete the endpoints of the curve.

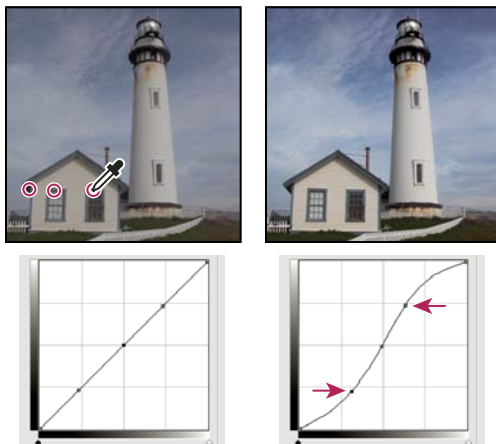

With the On-image adjustment tool selected, click three areas of an image to add points to the curve. Increased image contrast resulting from lightening the highlights and darkening displayed by an S-curve.

 To determine the lightest and darkest areas in an RGB image, drag across the image with the On-image adjustment tool. The *Curves* dialog box displays the intensity values of the area under the pointer, and the corresponding location on the curve. Dragging the pointer across a CMYK image shows the percentages in the *Color* panel, if it's set to display CMYK values.

5 Do one of the following to adjust the shape of the curve:

- Click a point, and drag the curve until the tone and color look correct. Shift-click to select multiple points and move them at once.
- Select the On-image adjustment tool . As you move the mouse pointer over the image it changes to an eyedropper, and an indicator on the curve shows the tonal value of the underlying pixels. Click on the image at the desired tonal value and drag vertically up or down to adjust the curve.
- Click a point on the curve, and enter values in the Input and Output text boxes.

- Select the pencil at the left of the curve grid, and drag to draw a new curve. You can hold down Shift to constrain the curve to a straight line, and click to define endpoints. When you are finished, click the Smooth icon  to smooth the curve (in the Curves Adjustments panel) or click Smooth (in the Curves dialog box).

Points on the curve remain anchored until you move them. As a result, you can make an adjustment in one tonal area while other areas remain unaffected.

Apply an Auto correction

- ❖ Click Auto in the Curves Adjustments panel or in the Curves dialog box.

Auto applies an automatic color correction using the current default setting. To change the default setting, use options in the Auto Color Correction Options dialog box. You can apply an Auto Color, Auto Contrast, or Auto Tone correction to an image. For more information on these options, see “[Set Auto adjustment options](#)” on page 187.

Set black and white points using the black point and white point sliders

Use the Black and White sliders to quickly set black and white points. For example, if you move the black point slider to the right at input 5, Photoshop maps all the pixels at input 5 and lower to level 0. Similarly, if you move the white point slider to the left at level 243, Photoshop maps all pixels at level 243 and higher to level 255. The mapping affects the darkest and lightest pixels in each channel. The corresponding pixels in the other channels are adjusted proportionately to avoid altering the color balance.

- 1 Drag the black and white point sliders to any point along the axis. As you drag, note that the input value changes.
- 2 To preview clipping as you adjust black and white points, do one of the following:
 - Hold down Alt (Windows) or Option (Mac OS) as you drag the sliders.
 - Choose Show Clipping For Black/White Points from the Adjustments panel menu, or Show Clipping in the Curves dialog box.

Set black and white points using the eyedropper tools

- 1 Double-click the Set Black Point Eyedropper tool. In the Adobe Color Picker, select a value where R, G, and B values are identical. To set the value to black, set R, G, and B values to 0.
- 2 With the eyedropper, click on an area in the image that represents the black point, or the area with lowest tonal values.
- 3 Double-click the Set White Point Eyedropper tool and select a color with identical R, G, and B values.
- 4 Click in an image area with the lightest tonal values to set the white point.

Keyboard shortcuts: Curves adjustment

You can use these keyboard shortcuts in the Curves adjustment:

- To set a point on the curve in the current channel specified in the Curves adjustment, Ctrl-click (Windows) or Command-click (Mac OS) in the image.
- To set a point on the curve for the selected color in each color component channel (but not in the composite channel), Shift+Ctrl-click (Windows) or Shift+Command-click (Mac OS) in the image.
- To select multiple points, Shift-click points on the curve. Selected points are filled with black.
- To deselect all points on the curve, click in the grid, or press Ctrl-D (Windows) or Command-D (Mac OS).
- To move selected points on the curve, press the arrow keys.

Color correct using the eyedroppers

You can use the eyedroppers in the Levels or Curves adjustment to correct a color cast such as an unwanted tint from an excess of color (red, green, blue, or cyan, magenta, yellow). It's easier to color-balance an image by first identifying an area that you want to be neutral and then removing the color cast from that area. Depending on the image, you can use one or all three of the eyedroppers. The eyedroppers work best on an image with easily identified neutrals.

Note: The Set Gray Point Eyedropper tool  is used primarily for color correction and is unavailable when you work with grayscale images.

For the best results, don't use the eyedroppers in images that require a large adjustment to map a pixel to the maximum highlight or minimum shadow values.

Important: Using the eyedroppers undoes any previous adjustment you made in Levels or Curves. If you plan to use the eyedroppers, it's best to use them first and then fine-tune your adjustments with the Levels sliders or Curves points.

- 1 Identify an area in the image that you want to be neutral gray. For example, a paved road.

 Use a color sampler to mark a neutral area so that you can click it with an eyedropper later.

- 2 Click the Levels or Curves icon in the Adjustments panel, or choose Layer > New Adjustment Layer, and then choose Levels or Curves.

Note: You can also choose Image > Adjustments, and then choose Level or Curves. You would complete the following steps in either the Level or Curves dialog box. But keep in mind that this method makes direct adjustments to the image layer and discards image information.

- 3 In the Adjustments panel, double-click the Set Gray Point tool . In the Adobe Color Picker, verify that the currently selected color has identical R, G, and B values (for example, 128,128,128).
- 4 With the Set Gray Point Eyedropper, click the neutral area that you identified in Step 1. This should reset midtones and remove the color cast from the image.
- 5 If necessary, make final adjustments in the Adjustments panel.

If you specified new target colors for an eyedropper, Photoshop asks whether you want to save the new target colors as defaults.

Adjust hue and saturation

Hue/Saturation lets you adjust the hue, saturation, and lightness of a specific range of colors in an image or simultaneously adjust all the colors in an image. This adjustment is especially good for fine-tuning colors in a CMYK image so that they are in the gamut of an output device.

You can save Hue/Saturation settings in the Adjustments panel and load them for reuse in other images. For more information, see “[Save adjustment settings](#)” on page 159 and “[Reapply adjustment settings](#)” on page 159.

Apply Hue/Saturation adjustment

- 1 Do one of the following:
 - Click the Hue/Saturation icon  or a Hue/Saturation preset in the Adjustments panel.
 - Choose Layer > New Adjustment Layer > Hue/Saturation. Click OK in the New Layer dialog box. The two color bars in the dialog box represent the colors in their order on the color wheel. The upper color bar shows the color before the adjustment; the lower bar shows how the adjustment affects all of the hues at full saturation.

Note: You can also choose Image > Adjustments > Hue/Saturation. But keep in mind that this method makes direct adjustments to the image layer and discards image information.

2 In the Adjustments panel, choose which colors to adjust using the Edit pop-up menu:

- Choose Master to adjust all colors at once.
- Choose one of the other preset color ranges listed for the color you want to adjust. To modify the color range, see “Adjust hue and saturation” on page 168.

3 For Hue, enter a value or drag the slider until you are satisfied with the colors.

The values displayed in the box reflect the number of degrees of rotation around the wheel from the original color of the pixel. A positive value indicates clockwise rotation; a negative value, counterclockwise rotation. Values can range from -180 to +180.

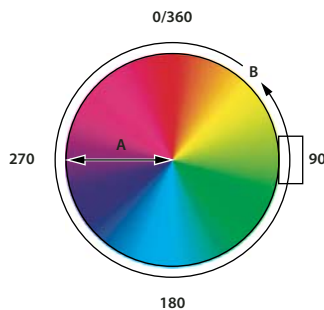

Color wheel
 A. Saturation B. Hue

💡 You can also select the On-image adjustment tool  in the Adjustments panel and then Ctrl-click (Windows) or Command-click (Mac OS) on a color in the image. Drag left or right in the image to modify the hue value.

4 For Saturation, enter a value or drag the slider to the right to increase the saturation or to the left to decrease it.

The color shifts away from or toward the center of the color wheel. Values can range from -100 (percentage of desaturation, duller colors) to +100 (percentage of saturation increase).

💡 You can also, select the On-image adjustment tool  in the Adjustments panel and click on a color in the image. Drag left or right in the image to decrease or increase saturation of the color range that includes the pixel you clicked.

5 For Lightness, enter a value or drag the slider to the right to increase the lightness (add white to a color) or to the left to decrease it (add black to a color). Values can range from -100 (percentage of black) to +100 (percentage of white).

Note: Click the Reset button  to undo a Hue/Saturation setting in the Adjustments panel.

Specify the range of colors adjusted in the Hue/Saturation adjustment



1 Do one of the following:

- Click the Hue/Saturation icon  in the Adjustments panel.
- Choose Layer > New Adjustment Layer > Hue/Saturation. Click OK in the New Layer dialog box.

Note: You can also choose Image > Adjustments > Hue/Saturation. But keep in mind that this method makes direct adjustments to the image layer and discards image information.

2 In the Adjustments panel, choose a color from the menu just above the sliders.

Four color wheel values (in degrees) appear in the Adjustments panel. They correspond to the adjustment sliders that appear between the color bars. The two inner vertical sliders define the color range. The two outer triangle sliders show where the adjustments on a color range “fall off” (*fall-off* is a feathering or tapering of the adjustments instead of a sharply defined on/off application of the adjustments).

- 3 Use either the eyedropper tools or the adjustment sliders to modify the range of colors.
 - Click or drag in the image with the Eyedropper tool  to select a color range. To expand the range, click or drag in the image with the Add To Sample Eyedropper tool . To reduce the range of color, click or drag in the image with the Subtract From Sample Eyedropper tool . While an eyedropper tool is selected, you can also press Shift to add to the range, or Alt (Windows) or Option (Mac OS) to subtract from it.
 - Drag one of the white triangle sliders to adjust the amount of color fall-off (feathering of adjustment) without affecting the range.
 - Drag the area between the triangle and the vertical bar to adjust the range without affecting the amount of fall-off.
 - Drag the center area to move the entire adjustment slider (which includes the triangles and vertical bars) to select a different color area.
 - Drag one of the vertical white bars to adjust the range of the color component. Moving a vertical bar from the center of the adjustment slider and closer to a triangle increases the color range and decreases the fall-off. Moving a vertical bar closer to the center of the adjustment slider and away from a triangle decreases the color range and increases the fall-off.
 - Ctrl-drag (Windows) or Command-drag (Mac OS) the color bar so that a different color is in the center of the bar.

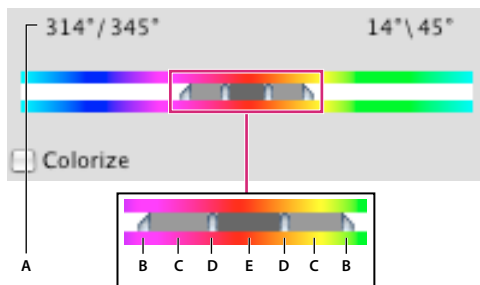

Hue/Saturation adjustment slider

A. Hue slider values B. Adjusts fall-off without affecting range C. Adjusts range without affecting fall-off D. Adjusts range of color and fall-off E. Moves entire slider

If you modify the adjustment slider so that it falls into a different color range, the name in the Edit menu changes to reflect this change. For example, if you choose Yellow and alter its range so that it falls in the red part of the color bar, the name changes to Red 2. You can convert up to six of the individual color ranges to varieties of the same color range (for example, Red through Red 6).

Note: By default, the range of color selected when you choose a color component is 30° wide, with 30° of fall-off on either side. Setting the fall-off too low can produce banding in the image.

Colorize a grayscale image or create a monotone effect

- 1 If you are colorizing a grayscale image, choose Image > Mode > RGB Color to convert the image to RGB.
- 2 Do one of the following to access the Hue/Saturation adjustment:
 - Click the Hue/Saturation icon  in the Adjustments panel.
 - Choose Layer > New Adjustment Layer > Hue/Saturation. Click OK in the New Layer dialog box.

Note: You can also choose Image > Adjustments > Hue/Saturation. But keep in mind that this method makes direct adjustments to the image layer and discards image information.

- 3 Select the Colorize option. If the foreground color is black or white, the image is converted to a red hue (0°). If the foreground color is not black or white, the image is converted to the hue of the current foreground color. The lightness value of each pixel does not change.

- 4 (Optional) Use the Hue slider to select a new color. Use the Saturation and Lightness sliders to adjust the saturation and lightness of the pixels.

Adjust color saturation using Vibrance

Vibrance adjusts the saturation so that clipping is minimized as colors approach full saturation. This adjustment increases the saturation of less-saturated colors more than the colors that are already saturated. Vibrance also prevents skintones from becoming over saturated.

1 Do one of the following:

- In the Adjustments panel, click the Vibrance icon .
- Choose Layer > New Adjustment Layer > Vibrance. In the New Layer dialog box, type a name for the Vibrance adjustment layer and click OK.

Note: You can also choose Image > Adjustments > Vibrance. But keep in mind that this method makes direct adjustments to the image layer and discards image information.

2 Do one of the following to adjust color saturation: Drag the Vibrance slider to increase or decrease color saturation without clipping when colors become more saturated.

- To apply more adjustment to less saturated colors and prevent colors clipping as they reach total saturation, move the Vibrance slider to the right.
- To apply the same amount of saturation adjustment to all colors regardless of their current saturation, move the Saturation slider. In some situations, this may produce less banding than the Saturation slider in the Hue/Saturation Adjustments panel or Hue/Saturation dialog box.
- To decrease saturation, move either the Vibrance or the Saturation slider to the left.

Convert a color image to black and white

The Black & White adjustment lets you convert a color image to grayscale while maintaining full control over how individual colors are converted. You can also tint the grayscale by applying a color tone to the image, for example to create a sepia effect. Black & White functions like the Channel Mixer, which also converts color images to monochrome while allowing you to adjust color channel input.

For a video on converting color images to black & white, see www.adobe.com/go/vid0017.

1 Do one of the following:

- Click the Black & White icon  or a Black & White preset in the Adjustments panel.
- Choose Layer > New Adjustment Layer > Black & White. In the New Layer dialog box, type a name for the adjustment layer and then click OK.

Photoshop applies a default grayscale conversion based on the color mix in the image.

Note: You can also choose Image > Adjustments > Black & White. But keep in mind that this method makes direct adjustments to the image layer and discards image information.

2 In the Adjustments panel, manually adjust the conversion using the color sliders, apply an Auto conversion, or select a previously saved custom mix.

Preset Select a predefined grayscale mix or a previously saved mix. To save a mix, choose Save Black & White Preset from the panel menu.

Auto Sets a grayscale mix based on the color values of the images, maximizing the distribution of gray values. The Auto mix often produces excellent results, or can be used as the starting point for tweaking gray values using the color sliders.

Color Sliders Adjust the gray tones of specific colors in an image. Drag a slider left to darken or right to lighten the gray tones of an image's original color.

- To adjust a particular color component, select the On-image adjustment tool  and then click in the image. Drag left or right to modify the color slider for the predominant color at that location, making it darker or brighter in the image.

***Note:** If you are using the Black & White dialog box instead of the Adjustments panel, click and hold on an image area to activate the color slider for the predominant color at that location, then drag horizontally to shift the slider.*

- Click the Reset button  to reset all color sliders to the default grayscale conversion.

Preview Deselect to view the image in its original color mode.

- 3 To apply a color tone to the grayscale, select the Tint option and adjust the Hue and Saturation sliders as needed. The Hue slider changes the tint color, the Saturation slider makes the color more or less concentrated. Click the color swatch to open the Color Picker and further fine-tune the tint color.

See also

“[Mix color channels](#)” on page 181

Improve shadow and highlight detail

The Shadow/Highlight command is suitable for correcting photos with silhouetted images due to strong backlighting or correcting subjects that have been slightly washed out because they were too close to the camera flash. The adjustment is also useful for brightening areas of shadow in an otherwise well-lit image. The Shadow/Highlight command does not simply lighten or darken an image; it lightens or darkens based on the surrounding pixels (local neighborhood) in the shadows or highlights. For this reason, there are separate controls of the shadows and the highlights. The defaults are set to fix images with backlighting problems.

The Shadow/Highlight command also has a Midtone Contrast slider, Black Clip option, and White Clip option for adjusting the overall contrast of the image, and a Color Correction slider for adjusting saturation.



Original image, and Shadow/Highlight Correction applied

Adjust image shadows and highlights

- 1 Choose Image > Adjustments > Shadow/Highlight.

Make sure that the Preview option is selected in the dialog box if you want the image to be updated as you make adjustments.

- 2 Adjust the amount of lighting correction by moving the Amount slider or entering a value in the Shadows or Highlights percentage box. Larger values provide either greater lightening of shadows or greater darkening of highlights. You can adjust both Shadows and Highlights in an image.
- 3 For finer control, select Show More Options to make the additional adjustments.

Note: To increase shadow detail in an otherwise well-exposed image, try values in the 0-25% range for Shadows Amount and Shadows Tonal Width.

- 4 (Optional) Click the Save As Defaults button to save your current settings and make them the default settings for the Shadow/Highlights command. To restore the original default settings, hold down the Shift key while clicking the Save As Defaults button.

Note: You can reuse Shadow/Highlight settings by clicking the Save button to save the current settings to a file and later using the Load button to reload them. For more information on saving and loading settings, see “[Save adjustment settings](#)” on page 159.

- 5 Click OK.

Shadow/Highlight command options

Amount Controls (separately for the highlight and shadow values in the image) how much of a correction to make.

Note: Extreme Amount values may lead to a crossover, where what started as a highlight becomes darker than something that started as a shadow; this can make the adjusted images look ‘unnatural’.

Tonal Width Controls the range of tones in the shadows or highlights that are modified. Smaller values restrict the adjustments to the darker regions for shadow correction and the lighter regions for highlight correction. Larger values increase the range of tones that are adjusted further into the midtones. For example, at 100% the shadow tonal width slider affects the shadows the most, the midtones are partially affected, but the brightest highlights are not affected. Tonal width varies from image to image. Too large a value may introduce halos around dark or light edges. The default settings attempt to reduce these artifacts. Halos may also occur when the Shadow or Highlight Amount values are too large.

 **Tonal Width** is set to 50% by default. If you find that you are trying to lighten a dark subject but the midtones or lighter regions are changing too much, try reducing Shadow Tone Width toward zero so that only the darkest regions are lightened. If, however, you want to brighten the midtones as well as the shadows, increase Shadows Tonal Width toward 100%.

Radius Controls the size of the local neighborhood around each pixel. Neighboring pixels are used to determine whether a pixel is in the shadows or highlights. Moving the slider to the left specifies a smaller area, and moving it to the right specifies a larger area. The optimum local neighborhood size depends on the image. It’s best to experiment with the adjustment. If the radius is too large, the adjustment tends to brighten (or darken) the whole image rather than brightening the subject only. It’s best to set the radius to roughly the size of the subjects of interest in the image. Experiment with different Radius settings to obtain the best balance between subject contrast and differential brightening (or darkening) of the subject compared to the background.

Brightness Adjusts the brightness in a grayscale image. This adjustment is available only for grayscale images. Moving the Brightness slider to the left darkens a grayscale image, and moving the slider to the right lightens a grayscale image.

Midtone Contrast Adjusts the contrast in the midtones. Move the slider to the left to reduce the contrast and to the right to increase the contrast. You can also enter a value in the Midtone Contrast box. A negative value reduces contrast, and a positive value increases contrast. Increasing midtone contrast produces greater contrast in the midtones while tending to darken the shadows and lighten the highlights.

Black Clip And White Clip Specifies how greatly the shadows and highlights are clipped to the new extreme shadow (level 0) and highlight (level 255) colors in the image. Larger values produce an image with greater contrast. Be careful

not to make the clipping values too large, because doing so reduces detail in the shadows or highlights (the intensity values are clipped and rendered as pure black or pure white).

Add contrast to a photo

You can add contrast to an image in two ways, depending on the problem.

If the image needs overall contrast because it doesn't use the full tonal range, click the Levels icon  in the Adjustments panel. Then drag the Shadow and Highlight input sliders inward until they touch the ends of the histogram.

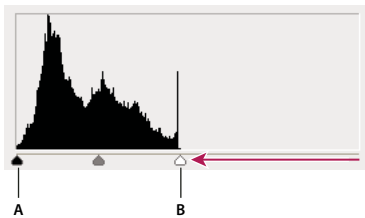

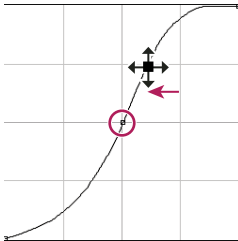

image layer don't extend to the ends of the graph, indicating that the image is not using the full tonal range.
 A. Shadow Input slider B. Highlight Input slider

If the image uses the full tonal range, but needs midtone contrast, Click the Curves icon  in the Adjustments panel. Drag the curve into an S shape.



Increasing the slope in the middle of the curve increases contrast in the midtones.

See also

[“About adjustment layers and fill layers”](#) on page 307

Adjust Exposure for HDR images

The Exposure adjustment is designed for making tonal adjustments to HDR images, but it works with 8-bit and 16-bit images. Exposure works by performing calculations in a linear color space (gamma 1.0) rather than the current color space.

1 Do one of the following:

- Click the Exposure icon  or an Exposure preset in the Adjustments panel.
- Choose Layer > New Adjustment Layer > Exposure.

Note: You can also choose Image > Adjustments > Exposure. But keep in mind that this method makes direct adjustments to the image layer and discards image information. Adjustment layers for 32-bit images are available in Photoshop Extended only.

2 In the Adjustments panel, set any of the following options:

Exposure Adjusts the highlight end of the tonal scale with minimal effect in the extreme shadows.

Offset Darkens the shadows and midtones with minimal effect on the highlights.

Gamma Adjusts the image gamma, using a simple power function. Negative values are mirrored around zero (that is, they remain negative but still get adjusted as if they are positive).

The eyedroppers adjust the luminance values of images (unlike the Levels eyedroppers that affect all color channels).

- The Set Black Point eyedropper sets the Offset, shifting the pixel you click to zero.
- The Set White Point eyedropper sets the Exposure, shifting the point you click to white (1.0 for HDR images).
- The Midtone eyedropper sets the Exposure, making the value you click middle gray.

See also

[“About high dynamic range images”](#) on page 71

Targeting images for press

Setting highlight and shadow target values

Assigning (targeting) highlight and shadow values of an image is necessary because most output devices (usually printing presses) cannot print detail in the blackest shadow values (near level 0) or the whitest highlight values (near level 255). Specifying the minimum shadow level and maximum highlight level helps to bring the important shadow and highlight details within the gamut of the output device.

If you are printing an image on a desktop printer and your system is color-managed, don't set target values. The Photoshop color management system automatically makes adjustments to the image you see on the screen so that it prints properly on your profiled desktop printer.

Using Levels to preserve highlight and shadow details for printing



The Output Levels sliders let you set the shadow and highlight levels to compress the image into a range less than 0 to 255. Use this adjustment to preserve the shadow and highlight details when an image is being printed on a press whose characteristics you know. For example, suppose there are important image details in the highlights with a value of 245, and the printing press that you're using won't hold a dot smaller than 5%. You can pull the highlight slider to level 242 (which is a 5% dot on the press) to shift the highlight detail from 245 to 242. Now, the highlight detail can safely print on that press.

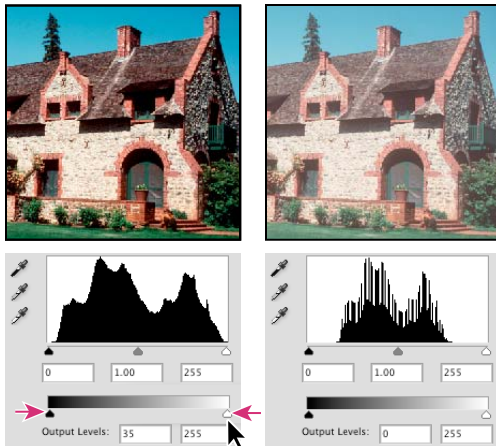

Generally, it is not a good idea to use the Output Levels sliders to target images with specular highlights. Your specular highlight will look gray rather than blow out to pure white. Use the highlight eyedropper for images with specular highlights.



Targeting shadows and highlights with Output Levels sliders

To set target values using the eyedroppers

- 1 Select the Eyedropper tool  in the toolbox. You can choose 3 by 3 Average from the Sample Size menu in the Eyedropper tool options. This ensures a representative sample of an area rather than the value of a single screen pixel.
- 2 Click the Levels  or Curves icon  in the Adjustments panel.



When you select Levels or Curves, the Eyedropper tool  is active outside the dialog box. You still have access to the scroll controls, the Hand tool, and the Zoom tool  through keyboard shortcuts.

- 3 Do one of the following to identify areas of highlights and shadows that you want to preserve in the image:
 - Move the pointer around the image, and look at the Info panel to find the lightest and darkest areas that you want preserved (not clipped to pure black or white). (See “View color values in an image” on page 153.)
 - Drag the pointer in the image, and look at Curves in the Adjustments panel box to find the lightest and darkest points you want to preserve. This method does not work if the Curves adjustment is set to the CMYK composite channel.

When identifying the lightest highlight details that you want targeted to a printable (lower) value, don’t include specular highlights. Specular highlights such as the highlight glint in jewelry or a spot of glare are meant to be the brightest points in an image. It’s desirable to clip specular highlight pixels (pure white, no detail) so that no ink is printed on the paper.

 You can also use the Threshold command to identify representative highlights and shadows before accessing Levels or Curves. (See “Create a two-valued black and white image” on page 190.)

- 4 To assign highlight values to the lightest area of the image, double-click the Set White Point Eyedropper tool  in the Levels or Curves adjustment to display the Color Picker. Enter the values you want to assign to the lightest area in the image, and click OK. Then click the highlight you identified in step 3.

 If you accidentally click the wrong highlight, click the Reset button  in the Adjustments panel.

Depending on the output device, you can achieve a good highlight in an average-key image using CMYK values of 5, 3, 3, and 0, respectively, when you are printing on white paper. An approximate RGB equivalent is 244, 244, 244, and an approximate grayscale equivalent is a 4% dot. You can approximate these target values quickly by entering 96 in the Brightness (B) box under the HSB area of the Color Picker.

💡 *With a low-key image, you may want to set the highlight to a lower value to avoid too much contrast. Experiment with Brightness values from 96 through 80.*

The pixel values are adjusted throughout the image proportionately to the new highlight values. Any pixels lighter than the area you clicked are clipped (adjusted to level 255, pure white). The Info panel shows the values both before and after the color adjustment.

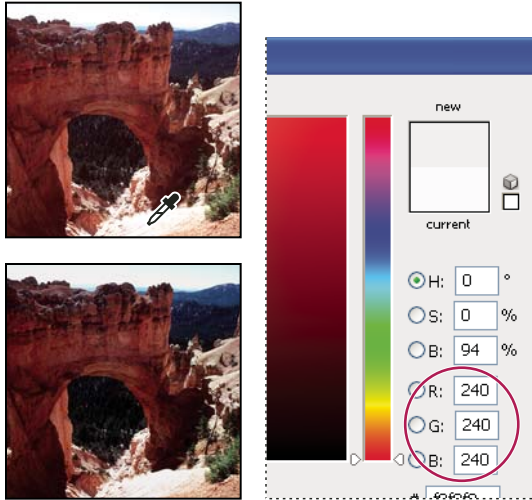

Setting the target value for the Set White Point Eyedropper tool and then clicking a highlight to assign it the target value

- 5 To assign shadow values to the darkest area of the image that you want preserved, double-click the Set Black Point Eyedropper tool  in the Adjustments panel to display the Color Picker. Enter the values you want to assign to the darkest area in the image, and click OK. Then click the shadow you identified in step 3.

When you're printing on white paper, you can usually achieve a good shadow in an average-key image using CMYK values of 65, 53, 51, and 95. An approximate RGB equivalent is 10, 10, 10, and an approximate grayscale equivalent is a 96% dot. You can approximate these values quickly by entering 4 in the Brightness (B) box under the HSB area of the Color Picker.

💡 *With a high-key image, you may want to set the shadow to a higher value to maintain detail in the highlights. Experiment with Brightness values from 4 through 20.*

Matching, replacing, and mixing colors

Match the color in different images

The Match Color command matches colors between multiple images, between multiple layers, or between multiple selections. It also lets you adjust the colors in an image by changing the luminance, changing the color range, and neutralizing a color cast. The Match Color command works only in RGB mode.

💡 *When you use the Match Color command, the pointer becomes the Eyedropper tool. Use the Eyedropper tool while adjusting the image to view the color pixel values in the Info panel. This panel gives you feedback about changes in color values as you use the Match Color command. See [“View color values in an image”](#) on page 153.*

The Match Color command matches the colors in one image (the source image) with colors in another image (the target image). Match Color is useful when you're trying to make the colors in different photos consistent, or when certain colors (such as skin tones) in one image must match the colors in another image.

In addition to matching the color between two images, the Match Color command can match the color between different layers in the same image.

Match the color between two images

1 (Optional) Make a selection in the source and target images.

If you don't make a selection, then the Match Color command matches the overall image statistics between images.

2 Make the image that you want to change active, and then choose Image > Adjustments > Match Color.

If you're applying the Match Color command to a specific layer in the target image, make sure that layer is active when you choose the Match Color command.

3 From the Source menu in the Image Statistics area of the Match Color dialog box, choose the source image whose colors you'll be matching in the target image. Choose None when you don't want to reference a different image to calculate the color adjustment. With None chosen, the target image and the source image are the same.

If necessary, use the Layer menu to choose the layer from the source image whose colors you want to match. You can also choose Merged from the Layer menu to match the colors from all the layers in the source image.

4 If you made a selection in the image, do one or more of the following:

- In the Destination Image area, select Ignore Selection When Applying Adjustment if you're applying the adjustment to the entire target image. This option ignores the selection in the target image and applies the adjustment to the entire target image.
 - In the Image Statistics area, select Use Selection In Source To Calculate Colors if you made a selection in the source image and want to use the colors in the selection to compute the adjustment. Deselect this option to ignore the selection in the source image, and use the colors from the entire source image to compute the adjustment.
 - In the Image Statistics area, select Use Selection In Target To Calculate Adjustment if you made a selection in the target image and want to use the colors in the selection to calculate the adjustment. Deselect this option to ignore the selection in the target image and compute the adjustment by using the colors of the entire target image.
- 5 To automatically remove a color cast in the target image, select the Neutralize option. Make sure that the Preview option is selected so that your image is updated as you make adjustments.
- 6 To increase or decrease the brightness in the target image, move the Luminance slider. Alternatively, enter a value in the Luminance box. The maximum value is 200, the minimum is 1, and the default is 100.
- 7 To adjust the color saturation in the target image, adjust the Color Intensity slider. Alternatively, enter a value in the Color Intensity box. The maximum value is 200, the minimum is 1 (which produces a grayscale image), and the default is 100.
- 8 To control the amount of adjustment applied to the image, move the Fade slider. Moving the slider to the right reduces the adjustment.
- 9 Click OK.

Match the color of two layers in the same image

1 (Optional) Make a selection in the layer you want to match. Use this method when matching a color region (for example, facial skin tones) in one layer with a region in another.

If you don't make a selection, then the Match Color matches the colors of the entire source layer.

2 Make sure that the layer you want to target (apply the color adjustment to) is active, and then choose Image > Adjustments > Match Color.

- 3 From the Source menu in the Image Statistics area of the Match Color dialog box, make sure that the image in the Source menu is the same as the target image.
- 4 Use the Layer menu to choose the layer whose colors you want to match. You can also choose Merged from the Layer menu to match the colors from all the layers.
- 5 If you made a selection in the image, do one or more of the following:
 - In the Destination Image area, select Ignore Selection When Applying Adjustment if you're applying the adjustment to the entire target layer. This option ignores the selection in the target layer and applies the adjustment to the entire target layer.
 - In the Image Statistics area, select Use Selection In Source To Calculate Colors if you made a selection in the source image and want to use the color in the selection to compute the adjustment. Deselect this option to ignore the selection in the source layer and use the colors in the entire source layer to compute the adjustment.
 - In the Image Statistics area, select Use Selection In Target To Calculate Adjustment if you want to use only the colors in the selected area of the target layer to compute the adjustment. Deselect this option to ignore the selection and use the colors of the entire target layer to compute the adjustment.
- 6 To automatically remove a color cast in the target layer, Select the Neutralize option. Make sure that the Preview option is selected so that your image is updated as you make adjustments.
- 7 To increase or decrease the brightness in the target layer, move the Luminance slider. Alternatively, enter a value in the Luminance box. The maximum value is 200, the minimum is 1, and the default is 100.
- 8 To adjust the range of color pixel values in the target layer, adjust the Color Intensity slider. Alternatively, enter a value in the Color Intensity box. The maximum value is 200, the minimum is 1 (which produces a grayscale image), and the default is 100.
- 9 To control the amount of adjustment applied to the image, adjust the Fade slider. Moving the slider to the right reduces the amount of adjustment.
- 10 Click OK.

Remove a color cast with Match Color

The Match Color command can adjust the brightness, color saturation, and color balance in an image. The advanced algorithms in the Match Color command give you better control over luminance and color components of the image. Because you are adjusting the color in a single image rather than matching the colors between two images, the image you're correcting is both the source and the target image.

- 1 Choose Image > Adjustments > Match Color.
- 2 In the Image Statistics area, make sure that None is chosen in the Source menu. The option specifies that the source and the target are the same image.
- 3 To automatically remove a color cast, select the Neutralize option. Make sure that the Preview option is selected so that your image is updated as you make adjustments.
- 4 To increase or decrease the brightness in the image, adjust the Luminance slider. Moving the Luminance slider to the left darkens the image, and moving the slider to the right brightens the image. The luminance control tries not to clip pixels (change them to pure black/no detail or pure white/no detail) in either the shadows or highlights. However, it may clip pixels because an image can have only either 8-bit or 16-bit values.
- 5 To increase or decrease the saturation of colors in the image, adjust the Color Intensity slider. Moving the Color Intensity slider to the left reduces the color saturation, and the image becomes monochromatic. Moving the Color Intensity to the right increases saturation and intensifies the colors.

- 6 To control the amount of adjustment applied to the image, adjust the Fade slider. Moving the slider to the right reduces the amount of adjustment.

Note: You can use the Match Color controls separately to apply a single correction to the image. For example, you can adjust only the Luminance slider to brighten/darken an image without affecting the color. Or you can use the controls in different combinations, depending on the color correction you're making.

- 7 Click OK.

Save and apply settings in the Match Color command

- In the Image Statistics area of the Match Color dialog box, click the Save Statistics button. Name and save the settings.
- In the Image Statistics area of the Match Color dialog box, click the Load Statistics button. Locate and load the saved settings file.



Replace the color of objects in an image

The Replace Color command lets you create a mask to select specific colors in an image and then replace those colors. You can set the hue, saturation, and lightness of the selected areas. Or you can use the Color Picker to select the replacement color. The mask created by the Replace Color command is temporary.

- 1 Choose Image > Adjustments > Replace Color.
- 2 (Optional) If you are selecting multiple color ranges in the image, select Localized Color Clusters to build a more accurate mask.
- 3 Select a display option:

Selection Displays the mask in the preview box. Masked areas are black, and unmasked areas are white. Partially masked areas (areas covered with a semitransparent mask) appear as varying levels of gray according to their opacity.

Image Displays the image in the preview box. This option is useful when you are working with a magnified image or have limited screen space.

- 4 To select the areas exposed by the mask, do one of the following:
 - Use the Eyedropper tool  to click in the image or in the preview box to select the areas exposed by the mask. Shift-click or use the Add To Sample Eyedropper tool  to add areas; Alt-click (Windows), Option-click (Mac OS), or use the Subtract From Sample Eyedropper tool  to remove areas.
 - Double-click the Selection swatch. Use the Color Picker to target the color you want replaced. As you select a color in the Color Picker, the mask in the preview box is updated.
- 5 Adjust the tolerance of the mask by dragging the Fuzziness slider or entering a value. This slider controls the degree to which related colors are included in the selection.
- 6 To change the color of the selected areas, do one of the following:
 - Drag the Hue, Saturation, and Lightness sliders (or enter values in the text boxes).
 - Double-click the Result swatch and use the Color Picker to select the replacement color.

You can also save the settings you make in the Replace Color dialog box for reuse in other images.

For a video on dodging and burning and using the Replace Color command, see www.adobe.com/go/lrvid4119_ps.

See also

[“Save adjustment settings”](#) on page 159

[“Reapply adjustment settings”](#) on page 159

Mix color channels

Using the Channel Mixer adjustment, you can create high-quality grayscale, sepia tone, or other tinted images. You can also make creative color adjustments to an image. To create high-quality grayscale images, choose the percentage for each color channel in the Channel Mixer adjustment. To convert a color image to grayscale and add tinting to the image, use the Black & White command (see [“Convert a color image to black and white”](#) on page 171).

The Channel Mixer adjustment options modify a targeted (output) color channel using a mix of the existing (source) color channels in the image. Color channels are grayscale images representing the tonal values of the color components in an image (RGB or CMYK). When you use the Channel Mixer, you are adding or subtracting grayscale data from a source channel to the targeted channel. You are not adding or subtracting colors to a specific color component as you do with the Selective Color adjustment.

Channel Mixer presets are available from the Preset menu in the Adjustments panel. Use the default Channel Mixer presets to create, save, and load custom presets.

See also

[“Save adjustment settings”](#) on page 159

[“Reapply adjustment settings”](#) on page 159

Mix color channels

- 1 In the Channels panel, select the composite color channel.
- 2 To access the Channel Mixer adjustment, do one of the following:
 - Click the Channel Mixer icon  or a Channel Mixer preset in the Adjustments panel.
 - Choose Layer > New Adjustment Layer > Channel Mixer. Click OK in the New Layer dialog box.

Note: You can also choose Image > Adjustments > Channel Mixer. But keep in mind that this method makes direct adjustments to the image layer and discards image information.

- 3 In the Adjustments panel, choose a channel from the Output Channel menu in which to blend one or more existing channels.

Choosing an output channel sets the source slider for that channel to 100% and all other channels to 0%. For example, choosing Red as the output channel sets the Source Channels sliders to 100% for Red, and to 0% for Green and Blue (in an RGB image).

- 4 To decrease the channel’s contribution to the output channel, drag a source channel slider to the left. To increase the channel’s contribution, drag a source channel slider to the right or enter a value between -200% and +200% in the box. Using a negative value inverts the source channel before adding it to the output channel.

Photoshop displays the total value of the source channels in the Total field. If the combined channel values are above 100%, Photoshop displays a warning icon next to the total.

- 5 Drag the slider or enter a value for the Constant option.

This option adjusts the grayscale value of the output channel. Negative values add more black, and positive values add more white. A -200% value makes the output channel black, and a +200% value makes the output channel white.

You can save Channel Mixer dialog box settings for reuse on other images. See “[Save adjustment settings](#)” on page 159 and “[Reapply adjustment settings](#)” on page 159.

Create monochrome images from RGB or CMYK images

- 1 In the Channels panel, select the composite color channel.
- 2 To access the Channel Mixer adjustment, do one of the following:
 - Click the Channel Mixer icon  in the Adjustments panel.
 - Select one of the default Channel Mixer presets in the Adjustments panel:

Black & White Infrared (RGB) Red=-70%, Green=200%, Blue=-30%

Black & White With Blue Filter (RGB) Red=0%, Green=0%, Blue=100%

Black & White With Green Filter (RGB) Red=0%, Green=100%, Blue=0%

Black & White With Orange Filter (RGB) Red=50%, Green=50%, Blue=0%

Black & White With Red Filter (RGB) Red=100%, Green=0%, Blue=0%

Black & White With Yellow Filter (RGB) Red=34%, Green=66%, Blue=0%

- Choose Layer > New Adjustment Layer > Channel Mixer. Click OK in the New Layer dialog box.

Note: You can also choose Image > Adjustments > Channel Mixer. But keep in mind that this method makes direct adjustments to the image layer and discards image information.

- 3 If you didn’t select a Channel Mixer preset, select Monochrome to set Gray as the output channel. Monochrome creates a color image that contains only gray values.
- 4 To control the amount of detail and contrast in the images before you convert them to grayscale, use the Source Channels sliders.

 Before adjusting the percentages of the source channels, view how each source channel affects the monochrome image. For example, in RGB, view the image with the Red channel set to +100% and the Green and Blue source channels set to 0%. Then, view the image with the Green source channel set to +100% and the other two channels set to 0%. Finally, view the image with Blue source channel set to +100% and the other channels set to 0%. For best results, try adjusting the percentages of the source channels so the combined values equal 100%.

Photoshop displays the total value of the source channels in the Total field. If the combined channel values are above 100%, Photoshop displays a warning icon next to the total.

- 5 (Optional) If you select and then deselect the Monochrome option, you can modify the blend of each channel separately, creating a hand-tinted appearance.



Hand-tinted effect created by selecting (left) and deselecting (right) the Monochrome option

- 6 (Optional) Drag the slider or enter a value for the Constant option.

This option adjusts the grayscale value of the output channel. Negative values add more black, and positive values add more white. A -200% value makes the output channel black; a +200% value makes the output channel white.

Make selective color adjustments

Selective color correction is a technique used by high-end scanners and separation programs to change the amount of process colors in each of the primary color components in an image. You can modify the amount of a process color in any primary color *selectively*—without affecting the other primary colors. For example, you can use selective color correction to dramatically decrease the cyan in the green component of an image while leaving the cyan in the blue component unaltered.

Even though Selective Color uses CMYK colors to correct an image, you can use it on RGB images.

- 1 Make sure that the composite channel is selected in the Channels panel. The Selective Color adjustment is available only when you're viewing the composite channel.
- 2 Do one of the following:
 - Click the Selective Color icon  or a Selective Color preset in the Adjustments panel.
 - Choose Layer > New Adjustment Layer > Selective Color. Click OK in the New Layer dialog box.

Note: You can also choose Image > Adjustments > Selective Color. But keep in mind that this method makes direct adjustments to the image layer and discards image information.

- 3 In the Adjustments panel, choose the color you want to adjust from the Colors menu.
- 4 Choose a method from the Adjustments panel menu:

Relative Changes the existing amount of cyan, magenta, yellow, or black by its percentage of the total. For example, if you start with a pixel that is 50% magenta and add 10%, 5% is added to the magenta (10% of 50% = 5%) for a total of 55% magenta. (This option cannot adjust pure specular white, which contains no color components.)

Absolute Adjusts the color in absolute values. For example, if you start with a pixel that is 50% magenta and add 10%, the magenta ink is set to a total of 60%.

Note: The adjustment is based on how close a color is to one of the options in the Colors menu. For example, 50% magenta is midway between white and pure magenta and receives a proportionate mix of corrections defined for the two colors.

- 5 Drag the sliders to increase or decrease the components in the selected color.

You can also save the settings you make for the Selective Color adjustment and reuse the settings on other images.

See also

[“Save adjustment settings”](#) on page 159

[“Reapply adjustment settings”](#) on page 159

Making quick image adjustments

Change the color balance using the Photo Filter command

The Photo Filter adjustment mimics the technique of placing a colored filter in front of the camera lens to adjust the color balance and color temperature of the light transmitted through the lens and exposing the film. Photo Filter also lets you choose a color preset to apply a hue adjustment to an image. If you want to apply a custom color adjustment, the Photo Filter adjustment lets you specify a color using the Adobe Color Picker.

- 1 Do one of the following:
 - Click the Photo Filter icon  in the Adjustments panel.

- Choose Layer > New Adjustment Layer > Photo Filter. Click OK in the New Layer dialog box.

Note: You can also choose Image > Adjustments > Photo Filter. But keep in mind that this method makes direct adjustments to the image layer and discards image information.

- 2 In the Adjustments panel, choose the filter color, either a custom filter or a preset. For a custom filter, select the Color option, click the color square, and use the Adobe Color Picker to specify a color for a custom color filter. For a preset filter, select the Filter option and choose one of the following presets from the Filter menu:

Warming Filter (85 and LBA) and Cooling Filter (80 and LBB) Color conversion filters that tune the white balance in an image. If an image was photographed with a lower color temperature of light (yellowish), the Cooling Filter (80) makes the image colors bluer to compensate for the lower color temperature of the ambient light. Conversely, if the photo was taken with a higher color temperature of light (bluish), the Warming Filter (85) makes the image colors warmer to compensate for the higher color temperature of the ambient light.

Warming Filter (81) and Cooling Filter (82) Use light-balancing filters for minor adjustments in the color quality of an image. The Warming Filter (81) makes the image warmer (more yellow), and the Cooling Filter (82) makes the image cooler (bluer).

Individual Colors Apply a hue adjustment to the image depending on the color preset you choose. Your choice of color depends on how you're using the Photo Filter adjustment. If your photo has a color cast, you can choose a complementary color to neutralize the color cast. You can also apply colors for special color effects or enhancements. For example, the Underwater color simulates the greenish blue color cast in underwater photos.

Make sure that Preview is selected to view the results of using a color filter. If you don't want the image darkened by adding the color filter, be sure that the Preserve Luminosity option is selected.

- 3 To adjust the amount of color applied to the image, use the Density slider or enter a percentage in the Density box. A higher density results in a stronger color adjustment.

Apply the Color Balance adjustment

The Color Balance command changes the overall mixture of colors in an image for generalized color correction.

- 1 Make sure that the composite channel is selected in the Channels panel. This command is available only when you're viewing the composite channel.
- 2 Do one of the following:
 - Click the Color Balance icon  in the Adjustments panel.
 - Choose Layer > New Adjustment Layer > Color Balance. Click OK in the New Layer dialog box.

Note: You can also choose Image > Adjustments > Color Balance. But keep in mind that this method makes direct adjustments to the image layer and discards image information.

- 3 In the Adjustments panel, select Shadows, Midtones, or Highlights to select the tonal range in which you want to focus the changes.
- 4 (Optional) Select Preserve Luminosity to prevent changing the luminosity values in the image while changing the color. This option maintains the tonal balance in the image.
- 5 Drag a slider toward a color that you want to increase in the image; drag a slider away from a color that you want to decrease in the image.

The values above the color bars show the color changes for the red, green, and blue channels. (For Lab images, the values are for the A and B channels.) Values can range from -100 to +100.

Apply the Brightness/Contrast adjustment

The Brightness/Contrast adjustment lets you make simple adjustments to the tonal range of an image. Moving the brightness slider to the right increases tonal values and expands image highlights, to the left decreases values and expands shadows. The contrast slider expands or shrinks the overall range of tonal values in the image.

In normal mode, Brightness/Contrast applies proportionate (nonlinear) adjustments to image layer, as with Levels and Curves adjustments. When Use Legacy is selected, Brightness/Contrast simply shifts all pixel values higher or lower when adjusting brightness. Since this can cause clipping or loss of image detail in highlight or shadow areas, using Brightness/Contrast in Legacy mode is not recommended for photographic images (but can be useful for editing masks or scientific imagery).

Note: Use Legacy is automatically selected when editing Brightness/Contrast adjustment layers created with previous versions of Photoshop.

1 Do one of the following:

- Click the Brightness/Contrast icon  in the Adjustments panel.
- Choose Layer > New Adjustment Layer > Brightness/Contrast. Click OK in the New Layer dialog box.

Note: You can also choose Image > Adjustments > Brightness/Contrast. But keep in mind that this method makes direct adjustments to the image layer and discards image information.

2 In the Adjustments panel, drag the sliders to adjust the brightness and contrast.

Dragging to the left decreases the level, and dragging to the right increases it. The number at the right of each slider reflects the brightness or contrast value. Values can range from -150 to +150 for Brightness, -50 to +100 for Contrast.

Adjust black and white points with the Auto option

The Auto option for Levels and Curves and the Auto Tone command automatically adjust the black point and white point in an image. This clips a portion of the shadows and highlights in each channel and maps the lightest and darkest pixels in each color channel to pure white (level 255) and pure black (level 0). The intermediate pixel values are redistributed proportionately. As a result, using the Auto option or Auto Tone increases the contrast in an image because the pixel values are expanded. Because the Auto option and Auto Tone adjust each color channel individually, it may remove color or introduce color casts.

The Auto option and Auto Tone give good results in certain images with an average distribution of pixel values that need a simple increase in contrast.

By default, the Auto option and the Auto Tone command clip the white and black pixels by 0.1%—that is, it ignores the first 0.1% of either extreme when identifying the lightest and darkest pixels in the image. The default settings for the Auto option can be changed in the Auto Color Correction Options dialog box.

1 Do one of the following:

- Click the Levels or Curves icon in the Adjustments panel.
- Choose Layer > New Adjustment Layer and choose either Levels or Curves. Click OK in the New Layer dialog box.

Note: You can choose Image > Auto Tone to apply the adjustment directly to the image layer. Keep in mind that this method discards image information and is automatic. You cannot adjust any of the options in the following steps.

2 In the Adjustments panel, Alt-click (Windows) or Option-click (Mac OS) the Auto button.

3 Under Algorithms in the Auto Color Correction Options dialog box, select Enhance Per Channel Contrast.

4 Adjust the amount of shadow and highlight values that are clipped, and adjust the target color for the midtones.

5 Click OK to apply the Auto option settings.

See also

[“Set Auto adjustment options”](#) on page 187

Apply the Auto Contrast adjustment

The Auto Contrast command adjusts image contrast automatically. Because Auto Contrast does not adjust channels individually, it does not introduce or remove color casts. It clips the shadow and highlight values in an image and then maps the remaining lightest and darkest pixels in the image to pure white (level 255) and pure black (level 0). This makes the highlights appear lighter and shadows appear darker.

By default, when identifying the lightest and darkest pixels in an image, Auto Contrast clips the white and black pixels by 0.5%—that is, it ignores the first 0.5% of either extreme. You can change this default using the Auto Color Correction Options found in the Levels and the Curves dialog boxes.

Auto Contrast can improve the appearance of many photographic or continuous-tone images. It does not improve flat-color images.

1 Do one of the following:

- Click the Levels or Curves icon in the Adjustments panel.
- Choose Layer > New Adjustment Layer and choose either Levels or Curves. Click OK in the New Layer dialog box.

Note: You can also choose Image > Auto Contrast to apply the adjustment directly to the image layer. Keep in mind that this method discards image information and its application is automatic. You cannot adjust any of the options in the following steps.

2 In the Adjustments panel, Alt-click (Windows) or Option-click (Mac OS) the Auto button.

3 Under Algorithms in the Auto Color Correction Options dialog box, select the Enhance Monochromatic Contrast option.

4 Specify the shadows and highlights that are clipped, and adjust the target color for the midtones.

5 Click OK to apply Auto Contrast.

See also

[“Set Auto adjustment options”](#) on page 187

Remove a color cast using Auto Color

Auto Color adjusts the contrast and color of an image by searching the image to identify shadows, midtones, and highlights. By default, Auto Color neutralizes the midtones using a target color of RGB 128 gray and clips the shadows and highlight pixels by 0.5%. You can change these defaults in the Auto Color Correction Options dialog box.

1 Do one of the following:

- Click the Levels or Curves icon in the Adjustments panel.
- Choose Layer > New Adjustment Layer and choose either Levels or Curves. Click OK in the New Layer dialog box.

Note: You can also choose Image > Auto Color to apply the adjustment directly to the image layer. Keep in mind that this method discards image information and is automatic. You cannot adjust any of the options in the following steps.

2 In the Adjustments panel, Alt-click (Windows) or Option-click (Mac OS) the Auto button.

3 Under Algorithms in the Auto Color Correction Options dialog box, select the Find Dark & Light colors option.

4 Select the Snap Neutral Midtones option.

- 5 Specify the shadows and highlights that are clipped, and adjust the target color for the midtones.
- 6 Click OK to apply Auto Color.

See also

“Adjust color using Levels” on page 163

“Set Auto adjustment options” on page 187

Set Auto adjustment options

The Auto Color Correction options control the automatic tone and color corrections available in both Levels and Curves. It also controls the settings for the Auto Tone, Auto Contrast, and Auto Color commands. The Auto Color Correction options let you specify shadow and highlight clipping percentages, and assign color values to shadows, midtones, and highlights.

You can apply the settings during a single use of the Levels or Curves adjustment, or you can save the settings as default values when applying Auto Tone, Auto Contrast, Auto Color, and the Auto option for Levels and Curves.

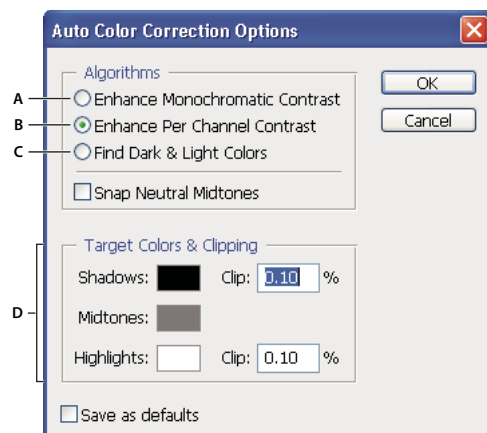

Auto Color Correction Options dialog box

A. Auto Contrast option B. Auto Levels option C. Auto Color option D. Set target colors, black point, and white point

- 1 Click the Levels or Curves icon in the Adjustments panel.
- 2 Alt-click (Windows) or Option-click (Mac OS) the Auto button in the Adjustments panel.
- 3 Specify the algorithm you want Photoshop to use to adjust the overall tonal range of an image:

Enhance Monochromatic Contrast Clips all channels identically. This preserves the overall color relationship while making highlights appear lighter and shadows appear darker. The Auto Contrast command uses this algorithm.

Enhance Per Channel Contrast Maximizes the tonal range in each channel to produce a more dramatic correction. Because each channel is adjusted individually, Enhance Per Channel Contrast may remove or introduce color casts. The Auto Tone command uses this algorithm.

Find Dark & Light Colors Finds the average lightest and darkest pixels in an image and uses them to maximize contrast while minimizing clipping. The Auto Color command uses this algorithm.

- 4 Select Snap Neutral Midtones if you want Photoshop to find an average nearly-neutral color in an image and then adjust the gamma (midtone) values to make the color neutral. The Auto Color command uses this algorithm.
- 5 To specify how much to clip black and white pixels, enter percentages in the Clip text boxes. A value between 0.0% and 1% is recommended.

By default, Photoshop clips the black and white pixels by 0.1%—that is, it ignores the first 0.1% of either extreme when identifying the lightest and darkest pixels in the image. Because of the better output quality of modern scanners and digital cameras, these default clipping percentages might be too high.

6 To assign (target) color values to the darkest, neutral, and lightest areas of an image, click a color swatch.

7 Do one of the following:

- To use the settings in the current Levels or Curves adjustment, click OK. If you then click the Auto button, Photoshop reapplies the same settings to the image.
- To save the settings as the default, select Save as Defaults, and then click OK. The next time you access Levels or Curves in the Adjustments panel, you can apply the same setting by clicking the Auto button. The Auto Tone, Auto Contrast, and Auto Color commands also use the default clipping percentages.

Note: When you save the Auto Color Correction options as defaults for Auto Color, Auto Tone, and Auto Contrast, it does not matter what algorithm you select in step 2. The three auto-correction commands use only those values that you set for the target colors and clipping. The only exception is that the Auto Color command also uses the Snap Neutral Midtones option.

Apply the Variations command

The Variations command lets you adjust the color balance, contrast, and saturation of an image by showing you thumbnails of alternatives.

This command is most useful for average-key images that don't require precise color adjustments. It does not work on indexed-color images or 16-bit-per-channel images.

1 Choose Image > Adjustments > Variations.

The two thumbnails at the top of the dialog box show the original selection (Original) and the selection with its currently selected adjustments (Current Pick). When you first open the dialog box, these two images are the same. As you make adjustments, the Current Pick image changes to reflect your choices.

2 Select the Show Clipping option if you want to display a preview of areas in the image that are clipped—converted to pure white or pure black—by the adjustment. Clipping can result in undesirable color shifts, as distinct colors in the original image are mapped to the same color. Clipping does not occur when you adjust midtones.

3 Select what to adjust in the image:

Shadows, Midtones, or Highlights Adjusts the dark, middle, or light areas.

Saturation Changes the degree of hue in the image. If you exceed the maximum saturation for a color, it may be clipped.

4 Drag the Fine/Coarse slider to determine the amount of each adjustment. Moving the slider one tick mark doubles the adjustment amount.

5 Adjust the color and brightness:

- To add a color to the image, click the appropriate color thumbnail.
- To subtract a color, click the thumbnail for its opposite color. For example, to subtract cyan, click the More Red thumbnail. See “[Understanding color](#)” on page 103.
- To adjust brightness, click a thumbnail on the right side of the dialog box.

The effects of clicking the thumbnails are cumulative. For example, clicking the More Red thumbnail twice applies the adjustment twice. Each time you click a thumbnail, the other thumbnails change. The three Current Pick thumbnails always reflect the current choices.

You can also save the settings you make in the Variations dialog box for reuse on other images. For more information on saving and loading settings, see “Save adjustment settings” on page 159 and “Reapply adjustment settings” on page 159.

Using the Equalize command

The Equalize command redistributes the brightness values of the pixels in an image so that they more evenly represent the entire range of brightness levels. Equalize remaps pixel values in the composite image so that the brightest value represents white, the darkest value represents black, and intermediate values are evenly distributed throughout the grayscale.

You can use the Equalize command when a scanned image appears darker than the original and you want to balance the values to produce a lighter image. Using Equalize together with the Histogram panel lets you see before-and-after brightness comparisons.

- 1 (Optional) Select an area of the image to equalize.
- 2 Choose Image > Adjustments > Equalize.
- 3 If you selected an area of the image, select what to equalize in the dialog box, and click OK:

Equalize Selected Area Only Evenly distributes only the pixels in the selection.

Equalize Entire Image Based On Selected Area Evenly distributes all image layers based on those in the selection.

Applying special color effects to images

Desaturate colors

The Desaturate command converts a color image to grayscale values, but leaves the image in the same color mode. For example, it assigns equal red, green, and blue values to each pixel in an RGB image. The lightness value of each pixel does not change.

This command has the same effect as setting Saturation to -100 in the Hue/Saturation adjustment.

Note: If you are working with a multilayer image, Desaturate converts the selected layer only.

- ❖ Choose Image > Adjustments > Desaturate.

Invert colors

The Invert adjustment inverts the colors in an image. You can use Invert as part of the process of making an edge mask to apply sharpening and other adjustments to selected areas of an image.

Note: Because color print film contains an orange mask in its base, the Invert adjustment cannot make accurate positive images from scanned color negatives. Be sure to use the proper settings for color negatives when scanning film.

When you invert an image, the brightness value of each pixel in the channels is converted to the inverse value on the 256-step color-values scale. For example, a pixel in a positive image with a value of 255 is changed to 0, and a pixel with a value of 5 is changed to 250.

Do one of the following:

- Click the Invert icon  in the Adjustments panel.
- Choose Layer > New Adjustment Layer > Invert. Click OK in the New Layer dialog box.

Note: You can also choose **Image > Adjustments > Invert**. But keep in mind that this method makes direct adjustments to the image layer and discards image information.

Create a two-valued black and white image

The Threshold adjustment converts grayscale or color images to high-contrast, black-and-white images. You can specify a certain level as a threshold. All pixels lighter than the threshold are converted to white; all pixels darker are converted to black.

1 Do one of the following:

- Click the Threshold icon  in the Adjustments panel.
- Choose **Layer > New Adjustment Layer > Threshold**. Click OK in the New Layer dialog box.

The Adjustments panel displays a histogram of the luminance levels of the pixels in the current selection.

Note: You can also choose **Image > Adjustments > Threshold**. But keep in mind that this method makes direct adjustments to the image layer and discards image information.

2 In the Adjustments panel, drag the slider below the histogram until the threshold level you want appears. As you drag, the image changes to reflect the new threshold setting.

Posterize an image

The Posterize adjustment lets you specify the number of tonal levels (or brightness values) for each channel in an image and then maps pixels to the closest matching level. For example, choosing two tonal levels in an RGB image gives six colors: two for red, two for green, and two for blue.

This adjustment is useful for creating special effects, such as large, flat areas in a photograph. Its effects are most evident when you reduce the number of gray levels in a grayscale image, but it also produces interesting effects in color images.

 *If you want a specific number of colors in your image, convert the image to grayscale and specify the number of levels you want. Then convert the image back to the previous color mode, and replace the various gray tones with the colors you want.*

1 Do one of the following:

- Click the Posterize icon  in the Adjustments panel.
- Choose **Layer > New Adjustment Layer > Posterize**.

Note: You can also choose **Image > Adjustments > Posterize**. But keep in mind that this method makes direct adjustments to the image layer and discards image information.

2 In the Adjustments panel, enter the number of tonal levels you want.

Apply a gradient map to an image

The Gradient Map adjustment maps the equivalent grayscale range of an image to the colors of a specified gradient fill. If you specify a two-color gradient fill, for example, shadows in the image are mapped to one of the endpoint colors of the gradient fill, highlights are mapped to the other endpoint color, and midtones are mapped to the gradations in between.

1 Do one of the following:

- Click the Gradient Map icon  in the Adjustments panel.

- Choose Layer > New Adjustment Layer > Gradient Map. Click OK in the New Layer dialog box.

Note: You can also choose Image > Adjustments > Gradient Map. But keep in mind that this method applies the adjustment directly to the image layer and discards image information.

2 In the Adjustments panel, specify the gradient fill you want to use:

- To choose from a list of gradient fills, click the triangle to the right of the gradient fill. Click to select the desired gradient fill, and then click in a blank area of the Adjustments panel to dismiss the list. For information on customizing the gradient fill list, see “[Work with the Preset Manager](#)” on page 41.
- To edit the gradient fill currently displayed in the Adjustment panel, click the gradient fill. Then modify the existing gradient fill or create a gradient fill using the Gradient Editor. (See “[Create a smooth gradient](#)” on page 352.)

By default, the shadows, midtones, and highlights of the image are mapped respectively to the starting (left) color, midpoint, and ending (right) color of the gradient fill.

3 Select either, none, or both of the Gradient options:

Dither Adds random noise to smooth the appearance of the gradient fill and reduces banding effects.

Reverse Switches the direction of the gradient fill, reversing the gradient map.

Chapter 8: Retouching and transforming

The retouch and transform features in Adobe® Photoshop® CS4 let you alter your images to accomplish a variety of tasks—to improve a composition, correct distortions or flaws, creatively manipulate picture elements, add or remove items, sharpen or blur, or merge multiple images into a panorama. The Vanishing Point feature lets you retouch and paint according to the perspective of an image. The Adobe® Photoshop® CS4 Extended version of Vanishing Point also lets you make measurements of items in an image and export the measurements along with geometric information and textures for use in 3D applications.

Adjusting crop, rotation, and canvas

Crop images

Cropping is the process of removing portions of an image to create focus or strengthen the composition. You can crop an image using the Crop tool  and the Crop command. You can also trim pixels using the Crop And Straighten and the Trim commands.





Using the Crop tool

See also

“[Resampling](#)” on page 59

Crop an image using the Crop tool

- 1 Select the Crop tool .
- 2 (Optional) Set resample options in the options bar.
 - To crop the image without resampling (default), make sure that the Resolution text box in the options bar is empty. You can click the Clear button to quickly clear all text boxes.
 - To resample the image during cropping, enter values for the height, width, and resolution in the options bar. The Crop tool won’t resample the image unless the width and/or height, and resolution are provided. If you’ve entered height and width dimensions and want the values quickly exchanged, click the Swaps Height And Width icon .



 You can click the triangle next to the Crop tool icon in the options bar to open the Tool Preset Picker and select a resampling preset. As with all Photoshop tools, you can create your own Crop tool preset. See also “[Create and use tool presets](#)” on page 25.

- To resample an image based on the dimensions and resolution of another image, open the other image, select the Crop tool, and click Front Image in the options bar. Then make the image you want to crop active.

Resampling while cropping uses the default interpolation method set in the General preferences.

- 3 Drag over the part of the image you want to keep to create a marquee. The marquee doesn't have to be precise—you can adjust it later.
- 4 If necessary, adjust the cropping marquee:
 - To move the marquee to another position, place the pointer inside the bounding box and drag.
 - To scale the marquee, drag a handle. To constrain the proportions, hold down Shift as you drag a corner handle.
 - To rotate the marquee, position the pointer outside the bounding box (the pointer turns into a curved arrow), and drag. To move the center point around which the marquee rotates, drag the circle at the center of the bounding box. The marquee can't be rotated in Bitmap mode.
- 5 Set options to hide or shield the cropped portions:
 - Specify whether you want to use a cropping shield to shade the area of the image that will be deleted or hidden. When Shield is selected, you can specify a color and opacity for the cropping shield. When Shield is deselected, the area outside the cropping marquee is revealed.
 - Specify whether you want to hide or delete the cropped area. Select Hide to preserve the cropped area in the image file. You can make the hidden area visible by moving the image with the Move tool . Select Delete to discard the cropped area.

The Hide option is not available for images that contain only a background layer. If you want to crop a background by hiding, convert the background to a regular layer first.

- 6 Do one of the following:
 - To complete the crop, press Enter (Windows) or Return (Mac OS), click the Commit button  in the options bar, or double-click inside the cropping marquee.
 - To cancel the cropping operation, press Esc or click the Cancel button  in the options bar.

Crop an image using the Crop command

- 1 Use a selection tool to select the part of the image you want to keep.
- 2 Choose Image > Crop.

Crop an image using the Trim command

The Trim command crops an image by removing unwanted image data in different ways than the Crop command. You can crop an image by trimming surrounding transparent pixels, or background pixels of the color you specify.

- 1 Choose Image > Trim.
- 2 In the Trim dialog box, select an option:
 - Transparent Pixels to trim away transparency at the edges of the image, leaving the smallest image containing nontransparent pixels.
 - Top Left Pixel Color to remove an area the color of the upper-left pixel from the image.
 - Bottom Right Pixel Color to remove an area the color of the lower right pixel from the image.
- 3 Select one or more areas of the image to trim away: Top, Bottom, Left, or Right.

Transform perspective while cropping

The Crop tool has an option that lets you transform the perspective in an image. This is very useful when working with images that contain *keystone distortion*. Keystone distortion occurs when an object is photographed from an angle rather than from a straight-on view. For example, if you take a picture of a tall building from ground level, the edges of the building appear closer to each other at the top than they do at the bottom.



Steps to transform perspective



A. Draw initial cropping marquee B. Adjust cropping marquee to match the object's edges C. Extend the cropping bounds D. Final image

- 1 Select the Crop tool  and set the crop mode.
- 2 Drag the cropping marquee around an object that was rectangular in the original scene (although it doesn't appear rectangular in the image). You'll use the edges of this object to define the perspective in the image. The marquee doesn't have to be precise—you'll adjust it later.

Important: You must select an object that was rectangular in the original scene or Photoshop might not produce the perspective transformation you expected.

- 3 Select Perspective in the options bar, and set the other options as desired.
- 4 Move the corner handles of the cropping marquee to match the object's edges. This defines the perspective in the image, so it is important to precisely match the object's edges.
- 5 Drag the side handles to extend the cropping bounds while preserving the perspective.

Do not move the center point of the cropping marquee. The center point needs to be in its original position in order to perform perspective correction.

- 6 Do one of the following:
 - Press Enter (Windows) or Return (Mac OS), click the Commit button  in the options bar, or double-click inside the cropping marquee.
 - To cancel the cropping operation, press Esc or click the Cancel button  in the options bar.

Crop and Straighten photos

You can place several photos on your scanner and scan them in one pass, which creates a single image file. The Crop and Straighten Photos command is an automated feature that can create separate image files from the multiple-image scan.

For best results, you should keep 1/8 inch between the images in your scan, and the background (typically the scanner bed) should be a uniform color with little noise. The Crop and Straighten Photos command works best on images with clearly delineated outlines. If the Crop and Straighten Photos command cannot properly process the image file, use the Crop tool.

- 1 Open the scanned file that contains the images you want to separate.
- 2 Select the layer that contains the images.
- 3 (Optional) Draw a selection around the images you want to process.

This is useful if you don't want to process all the images in the scan file.

- 4 Choose File > Automate > Crop And Straighten Photos. The scanned images are processed, and then each image opens in its own window.

 *If the Crop And Straighten Photos command incorrectly splits one of your images, make a selection border around the image and some background, and then hold down Alt (Windows) or Option (Mac OS) as you choose the command. The modifier key indicates that only one image should be separated from the background.*

Rotate or flip an entire image

The Image Rotation commands let you rotate or flip an entire image. The commands do not work on individual layers or parts of layers, paths, or selection borders. If you want to rotate a selection or layer, use the Transform or Free Transform commands.

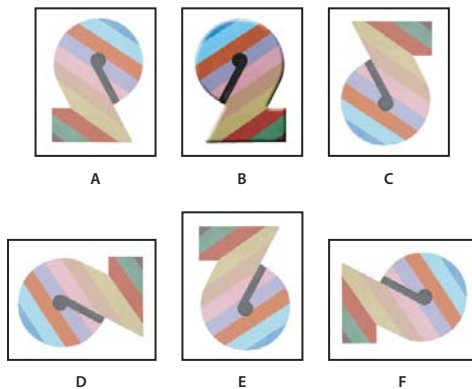

Rotating images

A. Flip Horizontal B. Original image C. Flip Vertical D. Rotate 90° CCW E. Rotate 180° F. Rotate 90° CW

❖ Choose Image > Image Rotation, and choose one of the following commands from the submenu:

180° Rotates the image by a half-turn.

90° CW Rotates the image clockwise by a quarter-turn.

90° CCW Rotates the image counterclockwise by a quarter-turn.

Arbitrary Rotates the image by the angle you specify. If you choose this option, enter an angle between -359.99 and 359.99 in the angle text box. (In Photoshop, you can select °CW or °CCW to rotate clockwise or counterclockwise.) Then click OK.

Note: Image Rotation is destructive editing and actually modifies the file information. If you want to non-destructively rotate the image for viewing, use the Rotation tool.

See also

“Flip or rotate precisely” on page 217

“Use the Rotate View tool” on page 27

Change the canvas size

The canvas size is the full editable area of an image. The Canvas Size command lets you increase or decrease an image’s canvas size. Increasing the canvas size adds space around an existing image. Decreasing an image’s canvas size crops into the image. If you increase the canvas size of an image with a transparent background, the added canvas is transparent. If the image doesn’t have a transparent background, there are several options for determining the color of the added canvas.

- 1 Choose Image > Canvas Size.
- 2 Do one of the following:
 - Enter the dimensions for the canvas in the Width and Height boxes. Choose the units of measurement you want from the pop-up menus next to the Width and Height boxes.
 - Select Relative, and enter the amount you want to add or subtract from the image’s current canvas size. Enter a positive number to add to the canvas, and enter a negative number to subtract from the canvas.
- 3 For Anchor, click a square to indicate where to position the existing image on the new canvas.
- 4 Choose an option from the Canvas Extension Color menu:
 - Foreground to fill the new canvas with the current foreground color
 - Background to fill the new canvas with the current background color
 - White, Black, or Gray to fill the new canvas with that color
 - Other to select a new canvas color using the Color Picker

Note: You can also click the white square to the right of the Canvas Extension Color menu to open the Color Picker.

The Canvas Extension Color menu isn’t available if an image doesn’t contain a background layer.

- 5 Click OK.

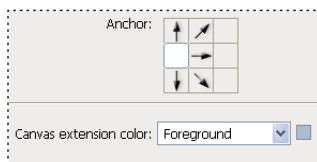

Original canvas, and canvas added to right side of image using the foreground color

Make a frame

You can make a photo frame by increasing the canvas size and filling it with a color.

You can also use one of the prerecorded actions to make a styled photo frame. It's best to do this on a copy of your photo.

- 1 Open the Actions panel. Choose Window > Actions.
- 2 Choose Frames from the Actions panel menu.
- 3 Choose one of the frame actions from the list.
- 4 Click the Play Selection button.

The action plays, creating the frame around your photo.

Retouching and repairing images

About the Clone Source panel

The Clone Source panel (Window > Clone Source) has options for the Clone Stamp tools or Healing Brush tools. You can set up to five different sample sources and quickly select the one you need without re-sampling each time you need to change to a different source. You can view an overlay of your sample source to make it easier to clone the source in a specific location. You can also scale or rotate the sample source to better match the size and orientation of the cloning destination.

(Photoshop Extended) For timeline-based animations, the Clone Source panel also has options for specifying the frame relationship between the sample source video/animation frame and the target video/animation frame. See also “Cloning content in video and animation frames (Photoshop Extended)” on page 541

For a video on repairing images, see www.adobe.com/go/vid0011.

See also

[Repairing images video](#)

Retouch with the Clone Stamp tool

The Clone Stamp tool  paints one part of an image over another part of the same image or over another part of any open document that has the same color mode. You can also paint part of one layer over another layer. The Clone Stamp tool is useful for duplicating objects or removing a defect in an image.

(Photoshop Extended) You can also use the Clone Stamp tool to paint content on video or animation frames. See also “Cloning content in video and animation frames (Photoshop Extended)” on page 541.

To use the Clone Stamp tool, you set a sampling point on the area you want to copy (clone) the pixels from and paint over another area. To paint with the most current sampling point whenever you stop and resume painting, select the Aligned option. Deselect the Aligned option to paint starting from the initial sampling point no matter how many times you stop and resume painting.

You can use any brush tip with the Clone Stamp tool, which gives you precise control over the size of the clone area. You can also use opacity and flow settings to control how paint will be applied to the cloned area.



Altering an image with the Clone Stamp tool

- 1 Select the Clone Stamp tool .
- 2 Choose a brush tip and set brush options for the blending mode, opacity, and flow in the options bar.
- 3 To specify how you want to align the sampled pixels and how to sample data from the layers in your document, set any of the following in the options bar:

Aligned Samples pixels continuously, without losing the current sampling point, even if you release the mouse button. Deselect Aligned to continue to use the sampled pixels from the initial sampling point each time you stop and resume painting.

Sample Samples data from the layers you specify. To sample from the active layer and visible layers below it, choose Current And Below. To sample only from the active layer, choose Current Layer. To sample from all visible layers, choose All Layers. To sample from all visible layers except adjustment layers, choose All Layers and click the Ignore Adjustment Layers icon to the right of the Sample pop-up menu.

- 4 Set the sampling point by positioning the pointer in any open image and Alt-clicking (Windows) or Option-clicking (Mac OS).
- 5 (Optional) In the Clone Source panel, click a clone source button  and set an additional sampling point.

You can set up to five different sampling sources. The Clone Source panel saves the sampled sources until you close the document.

- 6 (Optional) To select the sampled source you want, click a clone source button in the Clone Source panel.
- 7 (Optional) Do any of the following in the Clone Source panel:
 - To scale or rotate the source that you're cloning, enter a value for W (width), H (height), or the rotation in degrees . (Negative width and height values flip the source.)
 - To show an overlay of the source that you're cloning, select Show Overlay and specify the overlay options.

Note: Overlay can be clipped to the brush size when the Clipped option is enabled.

- 8 Drag over the area of the image you want to correct.

See also

[“List of blending modes”](#) on page 347

[“Retouching tools gallery”](#) on page 20

Set sample sources for cloning and healing



Using the Clone Stamp or Healing Brush tool, you can sample sources in the current document or any open document in Photoshop.

(Photoshop Extended) When cloning video or animation, you can set sampling points in the current frame you're painting or sample sources in a different frame, even if the frame is in a different video layer or in a different open document.

You can set up to five different sampling sources at a time in the Clone Source panel. The Clone Source panel saves the sampling sources until you close the document.

- 1 (Photoshop Extended only) To clone video or animation frames, open the Animation panel (if you're not cloning video or animation frames, skip to step 2). Select the timeline animation option and move the current-time indicator to the frame with the source you want to sample.
 - 2 To set the sampling point, select the Clone Stamp tool and Alt-click (Windows) or Option-click (Mac OS) in any open document window.
 - 3 (Optional) To set another sampling point, click a different Clone Source button  in the Clone Source panel.
- You can change the sampling source for a Clone Source button by setting a different sampling point.

Scale or rotate the sample source

- 1 Select the Clone Stamp or Healing Brush tool and set one or more source samples.
- 2 In the Clone Source panel, select a clone source and then do any of the following:
 - To scale the sample source, enter a percentage value for W (width) or H (height) or scrub W or H. The default is to constrain proportions. To adjust the dimensions independently or restore the constrain option, click the Maintain Aspect Ratio button .
 - To rotate the sample source, enter a degree value or scrub the Rotate The Clone Source icon .
 - To reset the sample source to its original size and orientation, click the Reset Transform button .

Adjust the sample source overlay options

Adjust the sample source overlay options to see the overlay and underlying images better when painting with the Clone Stamp and Healing Brush tools.

 To temporarily display the overlay while painting with the Clone Stamp tool, press Alt+Shift (Windows) or Option+Shift (Mac OS). The brush changes temporarily to the Move Source Overlay tool. Drag to move the overlay to another location.

- ❖ In the Clone Source panel, select Show Overlay and do any of the following:
 - To hide the overlay while you apply the paint strokes, select Auto Hide.
 - To clip overlay to the brush size, enable the Clipped option.
 - To set the opacity of the overlay, enter a percentage value in the Opacity text box.
 - To set the appearance of the overlay, choose either the Normal, Darken, Lighten, or Difference blending mode from the pop-up menu at the bottom of the Clone Source panel.
 - To invert the colors in the overlay, select Invert.

 To help align identical areas in the source overlay and underlying image, set Opacity to 50%, select Invert, and deselect Clipped. Matching image areas will appear solid gray when aligned.

Specify the clone source offset

When using the Clone Stamp tool or Healing Brush tool, you can paint with the sampled source anywhere in the target image. The overlay options will help you visualize where you want to paint. However, if you need to paint in a very specific location relative to the sampling point, you can specify the x and y pixel offset.

- ❖ In the Clone Source panel, select the source you want to use and enter the x and y pixel values for the Offset option.

Retouch with the Healing Brush tool

The Healing Brush tool lets you correct imperfections, causing them to disappear into the surrounding image. Like the cloning tools, you use the Healing Brush tool to paint with sampled pixels from an image or pattern. However, the Healing Brush tool also matches the texture, lighting, transparency, and shading of the sampled pixels to the pixels being healed. As a result, the repaired pixels blend seamlessly into the rest of the image.

(Photoshop Extended) The Healing Brush tool can be applied to video or animation frames.



Sampled pixels and healed image

- 1 Select the Healing Brush tool .
- 2 Click the brush sample in the options bar and set brush options in the pop-up panel:

Note: If you're using a pressure-sensitive digitizing tablet, choose an option from the Size menu to vary the size of the healing brush over the course of a stroke. Choose Pen Pressure to base the variation on the pen pressure. Choose Stylus Wheel to base the variation on the position of the pen thumbwheel. Choose Off if you don't want to vary the size.

Mode Specifies the blending mode. Choose Replace to preserve noise, film grain, and texture at the edges of the brush stroke when using a soft-edge brush.

Source Specifies the source to use for repairing pixels. Sampled to use pixels from the current image, or Pattern to use pixels from a pattern. If you chose Pattern, select a pattern from the Pattern pop-up panel.

Aligned Samples pixels continuously, without losing the current sampling point, even if you release the mouse button. Deselect Aligned to continue to use the sampled pixels from the initial sampling point each time you stop and resume painting.

Sample Samples data from the layers you specify. To sample from the active layer and visible layers below it, choose Current And Below. To sample only from the active layer, choose Current Layer. To sample from all visible layers, choose All Layers. To sample from all visible layers except adjustment layers, choose All Layers and click the Ignore Adjustment Layers icon to the right of the Sample pop-up menu.

- 3 Set the sampling point by positioning the pointer over an area of the image and Alt-clicking (Windows) or Option-clicking (Mac OS).

Note: If you are sampling from one image and applying to another, both images must be in the same color mode unless one of the images is in Grayscale mode.

- 4 (Optional) In the Clone Source panel, click a clone source button  and set an additional sampling point.

You can set up to 5 different sampling sources. The Clone Source panel remembers the sampled sources until you close the document you're editing.

- 5 (Optional) In the Clone Source panel, click a clone source button to select the sampled source you want.
- 6 (Optional) Do any of the following in the Clone Source panel:
 - To scale or rotate the source that you're cloning, enter a value for W (width), H (height), or the rotation in degrees .
 - To show an overlay of the source that you're cloning, select Show Overlay and specify the overlay options.
- 7 Drag in the image.

The sampled pixels are melded with the existing pixels each time you release the mouse button.

 *If there is a strong contrast at the edges of the area you want to heal, make a selection before you use the Healing Brush tool. The selection should be bigger than the area you want to heal but should precisely follow the boundary of contrasting pixels. When you paint with the Healing Brush tool, the selection prevents colors from bleeding in from the outside.*

See also

[“List of blending modes”](#) on page 347

[“About patterns”](#) on page 357

Retouch with the Spot Healing Brush tool

The Spot Healing Brush tool quickly removes blemishes and other imperfections in your photos. The Spot Healing Brush works similarly to the Healing Brush: it paints with sampled pixels from an image or pattern and matches the texture, lighting, transparency, and shading of the sampled pixels to the pixels being healed. Unlike the Healing Brush, the Spot Healing Brush doesn't require you to specify a sample spot. The Spot Healing Brush automatically samples from around the retouched area.

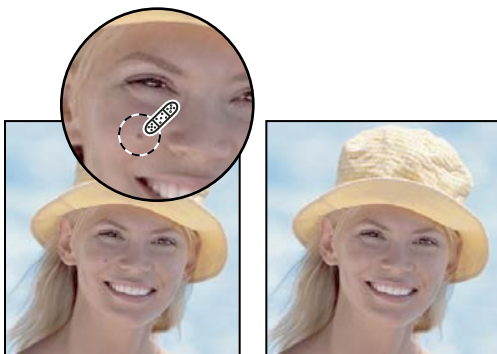

Using the Spot Healing Brush to remove a blemish

 *If you need to retouch a large area or need more control over the source sampling, you can use the Healing Brush instead of the Spot Healing Brush.*

- 1 Select the Spot Healing Brush tool  from the toolbox. If necessary, click either the Healing Brush tool, Patch tool, or Red Eye tool to show the hidden tools and make your selection.
- 2 Choose a brush size in the options bar. A brush that is slightly larger than the area you want to fix works best so that you can cover the entire area with one click.

3 (Optional) Choose a blending mode from the Mode menu in the options bar. Choose Replace to preserve noise, film grain, and texture at the edges of the brush stroke when using a soft-edge brush.

4 Choose a Type option in the options bar:

Proximity Match Uses the pixels around the edge of the selection to find an image area to use as a patch for the selected area. If this option doesn't provide a satisfactory fix, undo the fix and try the Create Texture option.

Create Texture Uses all the pixels in the selection to create a texture with which to fix the area. If the texture doesn't work, try dragging through the area a second time.

5 Select Sample All Layers in the options bar to sample data from all visible layers. Deselect Sample All Layers to sample only from the active layer.

6 Click the area you want to fix, or click and drag to smooth over imperfections in a larger area.

See also

[“List of blending modes”](#) on page 347

[“Retouching tools gallery”](#) on page 20

Patch an area

The Patch tool lets you repair a selected area with pixels from another area or a pattern. Like the Healing Brush tool, the Patch tool matches the texture, lighting, and shading of the sampled pixels to the source pixels. You can also use the Patch tool to clone isolated areas of an image. The Patch tool works with 8-bits or 16-bits-per-channel images.

 *When repairing with pixels from the image, select a small area to produce the best result.*

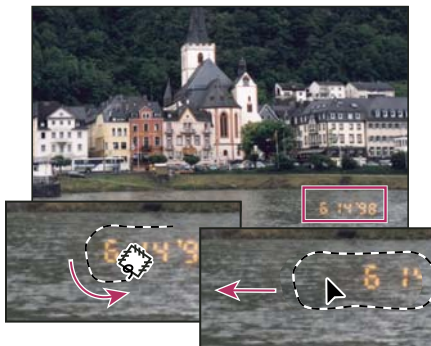

Using the Patch tool to replace pixels

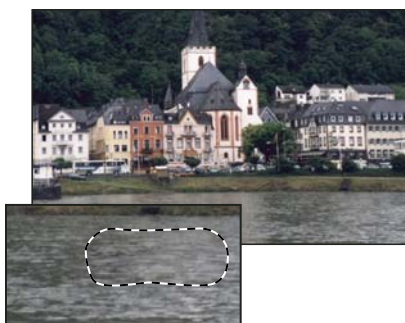

Patched image

Repair an area using sampled pixels



- 1 Select the Patch tool .
 - 2 Do one of the following:
 - Drag in the image to select the area you want to repair, and select Source in the options bar.
 - Drag in the image to select the area from which you want to sample, and select Destination in the options bar.
- Note: You can also make a selection prior to selecting the Patch tool.*
- 3 To adjust the selection, do one of the following:
 - Shift-drag in the image to add to the existing selection.
 - Alt-drag (Windows) or Option-drag (Mac OS) in the image to subtract from the existing selection.
 - Alt+Shift-drag (Windows) or Option+Shift-drag (Mac OS) in the image to select an area intersected by the existing selection.
 - 4 Position the pointer inside the selection, and do one of the following:
 - If Source is selected in the options bar, drag the selection border to the area from which you want to sample. When you release the mouse button, the originally selected area is patched with the sampled pixels.
 - If Destination is selected in the options bar, drag the selection border to the area you want to patch. When you release the mouse button, the newly selected area is patched with the sampled pixels.

Repair an area using a pattern

- 1 Select the Patch tool .
 - 2 Drag in the image to select the area you want to repair.
- Note: You can also make a selection prior to selecting the Patch tool.*
- 3 To adjust the selection, do one of the following:
 - Shift-drag in the image to add to the existing selection.
 - Alt-drag (Windows) or Option-drag (Mac OS) in the image to subtract from the existing selection.
 - Alt-Shift-drag (Windows) or Option-Shift-drag (Mac OS) in the image to select an area intersected by the existing selection.
 - 4 Select a pattern from the Pattern panel in the options bar, and click Use Pattern.

Remove red eye

The Red Eye tool removes red eye in flash photos of people or animals, and white or green reflections in flash photos of animals.

- 1 Select the Red Eye tool . (The Red Eye tool is in the same group as the Spot Healing Brush tool . Click the triangle in the lower right portion of a tool to display additional tools.)
- 2 Click in the red eye. If you are not satisfied with the result, undo the correction, set one or more of the following options in the options bar, and click the red eye again:

Pupil Size Increases or decreases the area affected by the Red Eye tool.

Darken Amount Sets the darkness of the correction.

 *Red eye is caused by a reflection of the camera flash in the subject's retina. You'll see it more often when taking pictures in a darkened room because the subject's iris is wide open. To avoid red eye, use the camera's red eye reduction feature. Or, better yet, use a separate flash unit that you can mount on the camera farther away from the camera's lens.*

Replace color in image areas

The Color Replacement tool simplifies replacing specific colors in your image. You can paint over a targeted color with a corrective color. The Color Replacement tool doesn't work in images in Bitmap, Indexed, or Multichannel color modes.

- 1 Select the Color Replacement tool .
- 2 Choose a brush tip in the options bar. Generally, you should keep the blending mode set to Color.
- 3 For the Sampling option, choose one of the following:

Continuous Samples colors continuously as you drag.

Once Replaces the targeted color only in areas containing the color that you first click

Background Swatch Replaces only areas containing the current background color.

- 4 For the Limits option, select one of the following:

Discontiguous Replaces the sampled color wherever it occurs under the pointer.

Contiguous Replaces colors that are contiguous with the color immediately under the pointer

Find Edges Replaces connected areas containing the sampled color while better preserving the sharpness of shape edges.

- 5 For tolerance, enter a percentage value (ranging from 0 to 255) or drag the slider. Choose a low percentage to replace colors very similar to the pixel you click, or raise the percentage to replace a broader range of colors.
- 6 To define a smooth edge in the corrected areas, select Anti-aliased.
- 7 Choose a foreground color to replace the unwanted color.
- 8 Click the color you want to replace in the image.
- 9 Drag in the image to replace the targeted color.

See also

[“List of blending modes”](#) on page 347

Smudge image areas

The Smudge tool simulates the effect you see when you drag a finger through wet paint. The tool picks up color where the stroke begins and pushes it in the direction you drag.

- 1 Select the Smudge tool .
- 2 Choose a brush tip and options for the blending mode in the options bar.
- 3 Select Sample All Layers in the options bar to smudge using color data from all visible layers. If this is deselected, the Smudge tool uses colors from only the active layer.
- 4 Select Finger Painting in the options bar to smudge using the foreground color at the beginning of each stroke. If this is deselected, the Smudge tool uses the color under the pointer at the beginning of each stroke.
- 5 Drag in the image to smudge the pixels.

 Press *Alt* (Windows) or *Option* (Mac OS) as you drag with the Smudge tool to use the Finger Painting option.

See also

[“List of blending modes”](#) on page 347

Blur image areas

The Blur tool softens hard edges or reduces detail in an image. The more you paint over an area with the tool, the blurrier it becomes.

- 1 Select the Blur tool .
- 2 Do the following in the options bar:
 - Choose a brush tip and set options for the blending mode and strength in the options bar.
 - Select Sample All Layers in the options bar to blur using data from all visible layers. If this is deselected, the tool uses data from only the active layer.
- 3 Drag over the part of the image you want to blur.

See also

[“Blur filters”](#) on page 389

[“List of blending modes”](#) on page 347

Sharpen image areas

The Sharpen tool increases contrast along edges to increase apparent sharpness. The more you paint over an area with the tool, the sharpen effect increases.

- 1 Select the Sharpen tool .
- 2 Do the following in the options bar:
 - Choose a brush tip and set options for the blending mode and strength in the options bar.
 - Select Sample All Layers in the options bar to sharpen using data from all visible layers. If this is deselected, the tool uses data from only the active layer.
- 3 Drag over the part of the image you want to sharpen.



See also

[“Sharpen filters”](#) on page 394

[“List of blending modes”](#) on page 347

Dodge or burn areas

Used to lighten or darken areas of the image, the Dodge tool and the Burn tool are based on a traditional photographer’s technique for regulating exposure on specific areas of a print. Photographers hold back light to lighten an area on the print (*dodging*) or increase the exposure to darken areas on a print (*burning*). The more you paint over an area with the Dodge or Burn tool, the lighter or darker it becomes.

- 1 Select the Dodge tool  or the Burn tool .

- 2 Choose a brush tip and set brush options in the options bar.
- 3 In the options bar, select one of the following from the Range menu:
 - Midtones** Changes the middle range of grays
 - Shadows** Changes the dark areas
 - Highlights** Changes the light areas
- 4 Specify the exposure for the Dodge tool or the Burn tool.
- 5 Click the airbrush button  to use the brush as an airbrush. Alternatively, select the Airbrush option in the Brushes panel.
- 6 Select the Protect Tones option to minimize clipping in the shadows and highlights. This option also tries to keep colors from shifting hue.
- 7 Drag over the part of the image you want to lighten or darken.

For a video on dodging and burning and using the Replace Color command, see www.adobe.com/go/lrvid4119_ps.

See also

“[Select a preset brush](#)” on page 333

Adjust color saturation in image areas

The Sponge tool subtly changes the color saturation of an area. When an image is in Grayscale mode, the tool increases or decreases contrast by moving gray levels away from or toward the middle gray.

- 1 Select the Sponge tool .
- 2 Choose a brush tip and set brush options in the options bar.
- 3 In the options bar, choose the way you want to change the color from the Mode menu:
 - Saturate** Intensifies the color’s saturation
 - Desaturate** Dilutes the color’s saturation
- 4 Specify the flow for the Sponge tool.
- 5 Select the Vibrance option to minimize clipping for fully saturated or desaturated colors.
- 6 Drag over the part of the image you want to modify.

See also

“[Select a preset brush](#)” on page 333

Correcting image distortion and noise

About lens distortion

Barrel distortion is a lens defect that causes straight lines to bow out toward the edges of the image. *Pincushion distortion* is the opposite effect, where straight lines bend inward.



Examples of barrel distortion (left) and pincushion distortion (right)

Vignetting is a defect where the edges, especially the corners, of an image are darker than the center. *Chromatic aberration* appears as a color fringe along the edges of objects caused by the lens focusing on different colors of light in different planes.

Some lenses exhibit these defects depending on the focal length or the f-stop used. You can set the Lens Correction filter to use settings based on the camera, lens, and focal length used to make the image.

Correct lens distortion and adjust perspective

The Lens Correction filter fixes common lens flaws such as barrel and pincushion distortion, vignetting, and chromatic aberration. The filter works with 8-bits and 16-bits-per-channel images only.

You can also use the filter to rotate an image or fix image perspective caused by vertical or horizontal camera tilt. The filter's image grid makes these adjustments easier and more accurate than using the Transform command.

Correct image perspective and lens flaws

- 1 Choose Filter > Distort > Lens Correction.
- 2 Set the grid and image zoom. As you work you may want to adjust the grid lines to help you judge the amount of correction to make. See Adjust the Lens Correction preview and grid, below.
- 3 (Optional) Choose a preset list of settings from the Settings menu. Lens Default uses settings that you previously saved for the camera, lens, focal length, and f-stop combination used to make the image. Previous Conversion uses the settings used in your last lens correction. Any group of custom settings you saved are listed at the bottom of the menu. See Set camera and lens defaults, below.
- 4 Set any of the following options to correct your image.

Remove Distortion Corrects lens barrel or pincushion distortion. Move the slider to straighten horizontal and vertical lines that bend either away from or toward the center of the image. You can also use the Remove Distortion tool  to make this correction. Drag toward the center of the image to correct for barrel distortion and toward the edge of the image to correct for pincushion distortion. Adjust the Edge option to specify how you want to handle any resulting blank image edges.

Chromatic Aberration Corrects color fringing. Zoom in on the image preview to get a closer view of the fringing as you make the correction.

Fix Red/Cyan Fringe Compensates for red/cyan color fringing by adjusting the size of the red channel relative to the green channel.

Fix Blue/Yellow Fringe Compensates for blue/yellow color fringing by adjusting the size of the blue channel relative to the green channel.

Vignette Corrects images that have darkened edges caused by lens faults or improper lens shading.

Amount Sets the amount of lightening or darkening along the edges of an image.

Midpoint Specifies the width of area affected by the Amount slider. Specify a lower number to affect more of the image. Specify a higher number to restrict the effect to the edges of the image.

Vertical Perspective Corrects image perspective caused by tilting the camera up or down. Makes vertical lines in an image parallel.

Horizontal Perspective Corrects image perspective, making horizontal lines parallel.

Angle Rotates the image to correct for camera tilt or to make adjustments after correcting perspective. You can also use the Straighten tool  to make this correction. Drag along a line in the image that you want to make vertical or horizontal.

Edge Specifies how to handle the blank areas that result from pincushion, rotation, or perspective corrections. You can fill blank areas with transparency or a color (background color), or you can extend the edge pixels of the image.

Scale Adjusts the image scale up or down. The image pixel dimensions aren't changed. The main use is to remove blank areas of the image caused by pincushion, rotation, or perspective corrections. Scaling up effectively results in cropping the image and interpolating up to the original pixel dimensions.

Adjust the Lens Correction preview and grid

- To change the image preview magnification, use the Zoom tool or the zoom controls in the lower left side of the preview image.
- To move the image in the preview window, select the Hand tool and drag in the image preview.
- To use the grid, select Show Grid at the bottom of the dialog box. Use the Size control to adjust the grid spacing and the Color control to change the color of the grid. You can move the grid to line it up with your image using the Move Grid tool .

Set camera and lens defaults

You can save the settings in the Lens Correction dialog box to reuse with other images made with the same camera, lens, and focal length. Photoshop saves settings for distortion, vignetting, and chromatic aberration. Perspective correction settings are not saved. You can save and reuse settings in two ways:

- Manually save and load settings. Set options in the dialog box, and then choose Save Settings from the Settings menu . To use the saved settings, choose them from the Settings menu. You can also load saved settings that don't appear in the menu using the Load Settings command in the Settings menu.
- Set a lens default. If your image has EXIF metadata for the camera, lens, focal length, and f-stop, you can save the current settings as a lens default. To save the settings, click the Set Lens Default button. When you correct an image that matches the camera, lens, focal length, and f-stop, the Lens Default option becomes available in the Settings menu. This option is not available if your image doesn't have EXIF metadata.

Reduce image noise and JPEG artifacts

Image noise appears as random extraneous pixels that aren't part of the image detail. Noise can be caused by photographing with a high ISO setting on a digital camera, underexposure, or shooting in a dark area with a long shutter speed. Low-end consumer cameras usually exhibit more image noise than high-end cameras. Scanned images may have image noise caused by the scanning sensor. Often, the film's grain pattern appears in the scanned image.

Image noise can appear in two forms: luminance (grayscale) noise, which makes an image look grainy or patchy, and color noise, which is usually visible as colored artifacts in the image.

Luminance noise may be more pronounced in one channel of the image, usually the blue channel. You can adjust the noise for each channel separately in Advanced mode. Before opening the filter, examine each channel in your image separately to see if noise is prevalent in one channel. You preserve more image detail by correcting one channel rather than making an overall correction to all channels.

- 1 Choose Filter > Noise > Reduce Noise.
- 2 Zoom in on the preview image to get a better view of image noise.
- 3 Set options:

Strength Controls the amount of luminance noise reduction applied to all image channels.

Preserve Details Preserves edges and image details such as hair or texture objects. A value of 100 preserves the most image detail, but reduces luminance noise the least. Balance the Strength and Preserve Details controls to fine-tune noise reduction.

Reduce Color Noise Removes random color pixels. A higher value reduces more color noise.

Sharpen Details Sharpens the image. Removing noise reduces image sharpness. Use the sharpening control in the dialog box or use one of the other Photoshop sharpening filters later to restore sharpness.

Remove JPEG Artifacts Removes blocky image artifacts and halos caused by saving an image using a low JPEG quality setting.

- 4 If luminance noise is more prevalent in one or two color channels, click the Advanced button and then choose the color channel from the Channel menu. Use the Strength and Preserve Details controls to reduce noise in that channel.

Adjusting image sharpness and blur

Sharpen images

Sharpening enhances the definition of edges in an image. Whether your images come from a digital camera or a scanner, most images can benefit from sharpening. The degree of sharpening needed varies depending on the quality of the digital camera or scanner. Keep in mind that sharpening cannot correct a severely blurred image.

Notes and tips about sharpening:

- Sharpen your image on a separate layer so that you can resharpen it later if you need to output it to a different medium.
- If you sharpen your image on a separate layer, set the layer's blending mode to Luminance to avoid color shifts along edges.
- Sharpening increases image contrast. If you find that highlights or shadows are clipped after you sharpen, use the layer blending controls (if you sharpen a separate layer) to prevent sharpening in highlights and shadows. See [“Specify a tonal range for blending layers”](#) on page 298.
- If you need to reduce image noise, do so before sharpening so that you don't intensify the noise.
- Sharpen your image multiple times in small amounts. Sharpen the first time to correct blur caused by capturing your image (scanning it or taking it with your digital camera). After you've color corrected and sized your image, sharpen it again (or a copy of it) to add the appropriate amount of sharpening for your output medium.
- If possible, judge your sharpening by outputting it to the final medium. The amount of sharpening needed varies among output media.

For greatest control use the Unsharp Mask (USM) filter or the Smart Sharpen filter to sharpen your images. Although Photoshop also has the Sharpen, Sharpen Edges, and Sharpen More filter options, these filters are automatic and do not provide controls and options.

You can sharpen your entire image or just a portion defined by a selection or mask. Because the Unsharp Mask and Smart Sharpen filters can be applied to only one layer at a time, you might need to merge layers or flatten your file to sharpen all image layers in a multilayered file.

***Note:** Don't be misled by the name Unsharp Mask, which comes from a darkroom technique used in traditional film-based photography. The filter sharpens images rather than the opposite.*

Sharpen using Smart Sharpen

The Smart Sharpen filter has sharpening controls not available with the Unsharp Mask filter. You can set the sharpening algorithm or control the amount of sharpening that occurs in shadow and highlight areas.

- 1 Zoom the document window to 100% to get an accurate view of the sharpening.
- 2 Choose Filter > Sharpen > Smart Sharpen.
- 3 Set the controls in the Sharpen tabs:

Amount Sets the amount of sharpening. A higher value increases the contrast between edge pixels, giving the appearance of greater sharpness.

Radius Determines the number of pixels surrounding the edge pixels affected by the sharpening. The greater the radius value, the wider the edge effects and the more obvious the sharpening.

Remove Sets the sharpening algorithm used to sharpen the image. Gaussian Blur is the method used by the Unsharp Mask filter. Lens Blur detects the edges and detail in an image, and provides finer sharpening of detail and reduced sharpening halos. Motion Blur attempts to reduce the effects of blur due to camera or subject movement. Set the Angle control if you choose Motion Blur.

Angle Sets the direction of motion for the Motion Blur option of the Remove control.

More Accurate Processes the file more slowly for a more accurate removal of blurring.

- 4 Adjust sharpening of dark and light areas using in the Shadow and Highlight tabs. (Click the Advanced button to display the tabs). If the dark or light sharpening halos appear too strong you can reduce them with these controls, which are only available for 8-bits and 16-bits-per-channel images:

Fade Amount Adjusts the amount of sharpening in the highlights or shadows.

Tonal Width Controls the range of tones in the shadows or highlights that are modified. Move the slider to the left or right to decrease or increase the Tonal Width value. Smaller values restrict the adjustments to only the darker regions for shadow correction and only the lighter regions for highlight correction.

Radius Controls the size of the area around each pixel that is used to determine whether a pixel is in the shadows or highlights. Moving the slider to the left specifies a smaller area, and moving it to the right specifies a larger area.

- 5 Click OK.

Sharpen using Unsharp Mask

The Unsharp Mask sharpens an image by increasing contrast along the edges in an image. The Unsharp Mask does not detect edges in an image. Instead, it locates pixels that differ in value from surrounding pixels by the threshold you specify. It then increases the contrast of neighboring pixels by the amount you specify. So, for neighboring pixels the lighter pixels get lighter and the darker pixels get darker.

In addition, you specify the radius of the region to which each pixel is compared. The greater the radius, the larger the edge effects.

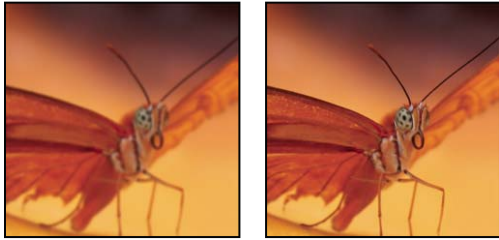

Original image, and Unsharp Mask applied

The degree of sharpening applied to an image is often a matter of personal choice. However, oversharpening an image produces a halo effect around the edges.



Oversharpening an image produces a halo effect around the edges.

The effects of the Unsharp Mask filter are more pronounced on-screen than in high-resolution output. If your final destination is print, experiment to determine what settings work best for your image.

- 1 (Optional) If your image is multilayered, select the layer containing the image you want to sharpen. You can apply Unsharp Mask to only one layer at a time, even if layers are linked or grouped. You can merge the layers before applying the Unsharp Mask filter.
- 2 Choose Filter > Sharpen > Unsharp Mask. Make sure the Preview option is selected.

 Click the image in the preview window and hold down the mouse to see how the image looks without the sharpening. Drag in the preview window to see different parts of the image, and click + or - to zoom in or out.

Although there is a preview window in the Unsharp Mask dialog box, it's best to move the dialog box so you can preview the effects of the filter in the document window.

- 3 Drag the Radius slider or enter a value to determine the number of pixels surrounding the edge pixels that affect the sharpening. The greater the radius value, the wider the edge effects. And the wider the edge effects, the more obvious the sharpening.

The Radius value varies according to the subject matter, the size of the final reproduction, and the output method. For high-resolution images, a Radius value between 1 and 2 is usually recommended. A lower value sharpens only the edge pixels, whereas a higher value sharpens a wider band of pixels. This effect is much less noticeable in print than on-screen, because a 2-pixel radius represents a smaller area in a high-resolution printed image.

- 4 Drag the Amount slider or enter a value to determine how much to increase the contrast of pixels. For high-resolution printed images, an amount between 150% and 200% is usually recommended.

- 5 Drag the Threshold slider or enter a value to determine how different the sharpened pixels must be from the surrounding area before they are considered edge pixels and sharpened by the filter. For instance, a threshold of 4 affects all pixels that have tonal values that differ by a value or 4 or more, on a scale of 0 to 255. So, if adjacent pixels have tonal values of 128 and 129, they are not affected. To avoid introducing noise or posterization (in images with flesh tones, for example), use an edge mask or try experimenting with Threshold values between 2 and 20. The default Threshold value (0) sharpens all pixels in the image.

 *If applying Unsharp Mask makes already bright colors appear overly saturated, choose Edit > Fade Unsharp Mask and choose Luminosity from the Mode menu.*

Sharpen selectively

You can sharpen parts of your image by using a mask or a selection. This is useful when you want to prevent sharpening in certain parts of your image. For example, you can use an edge mask with the Unsharp Mask filter on a portrait to sharpen the eyes, mouth, nose, and outline of the head, but not the texture of the skin.



Using an edge mask to apply the Unsharp Mask only to specific features in an image

Sharpen a selection

- 1 With the image layer selected in the Layers panel, draw a selection.
- 2 Choose Filter > Sharpen > Unsharp Mask. Adjust the options and click OK.

Only the selection is sharpened, leaving the rest of the image untouched.

Sharpen an image using an edge mask

- 1 Create a mask to apply sharpening selectively. There are many ways to create an edge mask. Use your favorite method, or try this one:
 - Open the Channels panel and select the channel that displays the grayscale image with the greatest contrast in the document window. Often, this is the green or the red channel.

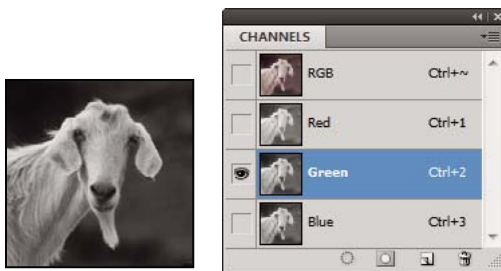

Selecting a channel with the greatest contrast

- Duplicate the selected channel.
- With the duplicate channel selected, choose Filter > Stylize > Find Edges.

- Choose Image > Adjustments > Invert to invert the image.

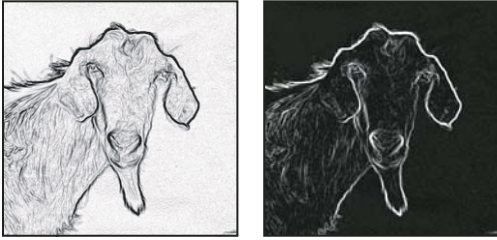

Find Edges filter applied and image inverted

- With the inverted image still selected, choose Filter > Other > Maximum. Set the radius to a low number and click OK to thicken the edges and randomize the pixels.
- Choose Filter > Noise > Median. Set the radius to a low number and click OK. This averages the neighboring pixels.
- Choose Image > Adjustment > Levels and set the black point high to get rid of random pixels. If necessary, you can also paint with black to retouch the final edge mask.



Setting the black point high in Levels to eliminate random pixels in the edge mask

- Choose Filter > Blur > Gaussian Blur to feather the edges.

Important: *The Maximum, the Median, and the Gaussian Blur filters soften the edge mask so that the sharpening effects blend better in the final image. Although all three filters are used in this procedure, you can experiment using only one or two.*

- 2 In the Channels panel, Ctrl-click (Windows) or Command-click (Mac OS) the duplicate channel to make the edge mask a selection.
- 3 In the Layers panel, select the image layer. Make sure the selection is still visible on the image.
- 4 Choose Select > Inverse.
- 5 With the selection active on the image layer, choose Filter > Sharpen > Unsharp Mask. Set the desired options and click OK.

To view your results, select the RGB channel in the Channels panel and deselect the selection in the image.

 *You can create an action to conveniently apply all the steps in the procedure.*

Add lens blur

Adds blur to an image to give the effect of a narrower depth of field so that some objects in the image stay in focus and others areas are blurred. You can use a simple selection to determine which areas are blurred, or you can provide a separate alpha channel *depth map* to describe exactly how you want the blur added.

The Lens Blur filter uses the depth map to determine the position of pixels in an image. With a depth map selected, you can also use the crosshair cursor to set the starting point of a given blur. You can use alpha channels and layer masks to create depth maps; black areas in an alpha channel are treated as though they're at the front of the photo, and white areas are treated as if they're far in the distance.

 *To create a gradual blurring (none at the bottom to maximum at the top), create a new alpha channel and apply a gradient so that the channel is white at the top of the image and black at the bottom. Then select the Lens Blur filter and choose the alpha channel from the Source pop-up menu. To change the direction of the gradient, select the Invert check box.*

The way the blur appears depends on the iris shape you choose. Iris shapes are determined by the number of blades they contain. You can change blades of an iris by curving them (making them more circular) or rotating them. You can also reduce or magnify the preview by clicking the minus button or the plus button.

- 1 Choose Filter > Blur > Lens Blur.
- 2 For Preview, Choose Faster to generate quicker previews. Choose More Accurate to view the final version of the image. More Accurate previews take longer to generate.
- 3 For Depth Map, choose a source (if you have one) from the Source pop-up menu. Drag the Blur Focal Distance slider to set the depth at which pixels are in focus. For example, if you set focal distance to 100, pixels at 1 and at 255 are completely blurred, and pixels closer to 100 are blurred less. If you click in the preview image, the Blur Focal Distance slider changes to reflect the clicked location and brings the depth of the clicked location into focus.
- 4 To invert the selection or alpha channel you're using as the depth map source, select Invert.
- 5 Choose an iris from the Shape pop-up menu. If you wish, drag the Blade Curvature slider to smooth the edges of the iris, or drag the Rotation slider to rotate it. To add more blur, drag the Radius slider.
- 6 For Specular Highlight, drag the Threshold slider to select a brightness cutoff; all pixels brighter than the cutoff value are treated as specular highlights. To increase the brightness of the highlights, drag the Brightness slider.
- 7 To add noise to an image, choose Uniform or Gaussian. To add noise without affecting color, choose Monochromatic. Drag the Amount slider to increase or decrease noise.

 *Blurring removes film grain and noise from the original image. To make the image look realistic and unretouched, you can return some of the removed noise to the image.*

- 8 Click OK to apply the changes to your image.

Transforming objects

Apply transformations

Transforming scales, rotates, skews, stretches, or warps an image. You can apply transformations to a selection, an entire layer, multiple layers, or a layer mask. You can also apply transformations to a path, a vector shape, a vector mask, a selection border, or an alpha channel. Transforming affects image quality when you manipulate the pixels. To apply non-destructive transformations to raster images, use Smart Objects. (See “[About Smart Objects](#)” on page 310.) Transforming a vector shape or path is always non-destructive because you're only changing the mathematical calculations producing the object.

To make a transformation, first select an item to transform and then choose a transformation command. If necessary, adjust the reference point before manipulating the transformation. You can perform several manipulations in succession before applying the cumulative transformation. For example, you can choose Scale and drag a handle to scale, and then choose Distort and drag a handle to distort. Then press Enter or Return to apply both transformations.

Photoshop uses the interpolation method selected in the General area of the Preferences dialog box to calculate the color values of pixels that are added or deleted during transformations. This interpolation setting directly affects the speed and quality of the transformation. Bicubic interpolation, the default, is slowest but yields the best results.

Note: You can also warp and distort raster images using the *Liquify* filter.

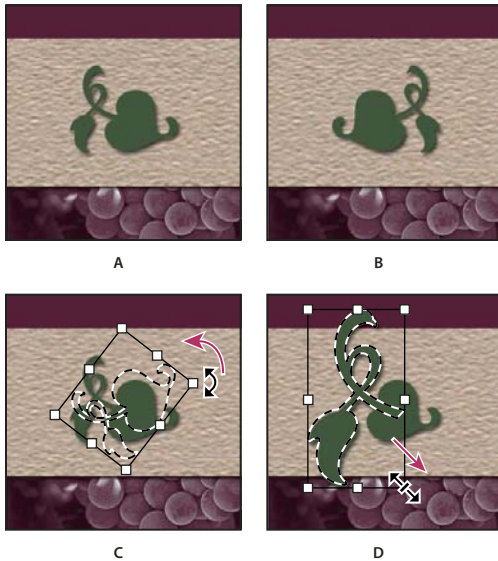

Transforming an image
 A. Original image B. Layer flipped C. Selection border rotated D. Part of object scaled

Transform submenu commands

Scale Enlarges or reduces an item relative to its *reference point*, the fixed point around which transformations are performed. You can scale horizontally, vertically, or both horizontally and vertically.

Rotate Turns an item around a reference point. By default, this point is at the center of the object; however, you can move it to another location.

Skew Slants an item vertically and horizontally.

Distort Stretches an item in all directions.

Perspective Applies one-point perspective to an item.

Warp Manipulates the shape of an item.

Rotate 180, Rotate 90 CW, Rotate 90 CCW Rotates the item by the specified number of degrees, either clockwise or counterclockwise.

Flip Flips the item vertically or horizontally.



Select an item to transform

❖ Do one of the following:

- To transform an entire layer, make the layer active, and make sure nothing is selected.

Important: You cannot transform the background layer. To transform it, first convert it to a regular layer.

- To transform part of a layer, select the layer in the Layers panel, and then select part of the image on that layer.

- To transform multiple layers, do either of the following in the Layers panel: link the layers together, or select multiple layers by Ctrl-clicking (Windows) or Command-clicking (Mac OS) more than one layer. In the Layers panel, you can also Shift-click to select contiguous layers.
- To transform a layer mask or a vector mask, unlink the mask and select the mask thumbnail in the Layers panel.
- To transform a path or vector shape, use the Path Selection tool  to select the entire path or the Direct Selection tool  to select part of the path. If you select one or more points on a path, only those path segments connected to the points are transformed.
- To transform a selection border, make or load a selection. Then choose Select > Transform Selection.
- To transform an alpha channel, select the channel in the Channels panel.



See also

“[Link and unlink layers](#)” on page 285

“[Select a path](#)” on page 373

Set or move the reference point for a transformation

All transformations are performed around a fixed point called the *reference point*. By default, this point is at the center of the item you are transforming. However, you can change the reference point or move the center point to a different location using the reference point locator in the options bar.

- 1 Choose a transformation command. A bounding box appears in the image.
- 2 Do one of the following:
 - In the options bar, click a square on the reference point locator . Each square represents a point on the bounding box. For example, to move the reference point to the upper-left corner of the bounding box, click the top left square on the reference point locator.
 - In the transform bounding box that appears in the image, drag the reference point . The reference point can be outside the item you want to transform.

Scale, rotate, skew, distort, apply perspective, or warp

- 1 Select what you want to transform.
- 2 Choose Edit > Transform > Scale, Rotate, Skew, Distort, Perspective, or Warp.

Note: *If you are transforming a shape or entire path, the Transform menu becomes the Transform Path menu. If you are transforming multiple path segments (but not the entire path), the Transform menu becomes the Transform Points menu.*

- 3 (Optional) In the options bar, click a square on the reference point locator .
- 4 Do one or more of the following:
 - If you chose Scale, drag a handle on the bounding box. Press Shift as you drag a corner handle to scale proportionately. When positioned over a handle, the pointer becomes a double arrow.
 - If you chose Rotate, move the pointer outside the bounding border (it becomes a curved, two-sided arrow), and then drag. Press Shift to constrain the rotation to 15° increments.
 - If you chose Skew, drag a side handle to slant the bounding box.
 - If you chose Distort, drag a corner handle to stretch the bounding box.
 - If you chose Perspective, drag a corner handle to apply perspective to the bounding box.



- If you chose Warp, choose a warp from the Warp Style pop-up menu in the options bar, or to perform a custom warp, drag the control points, a line, or an area within the mesh to change the shape of the bounding box and mesh.
- For all types of transformations, enter a value in the options bar. For example, to rotate an item, specify degrees in the rotation  text box.

5 (Optional) If desired, switch to a different type of transformation by selecting a command from the Edit > Transform submenu.

Important: When you transform a bitmap image (versus a shape or path), the image becomes slightly less sharp each time you commit a transformation; therefore, performing multiple commands before applying the cumulative transformation is preferable to applying each transformation separately.

6 (Optional) If you want to warp the image, click the Switch Between Free Transform And Warp Mode button  in the options bar.

7 When you finish, do one of the following:

- Press Enter (Windows) or Return (Mac OS), click the Commit button  in the options bar, or double-click inside the transformation marquee.
- To cancel the transformation, press Esc or click the Cancel button  in the options bar.

See also

“Warp an item” on page 219

Flip or rotate precisely

1 Select what you want to transform.

2 Choose Edit > Transform and choose one of the following commands from the submenu:

- Rotate 180° to rotate by a half-turn
- Rotate 90° CW to rotate clockwise by a quarter-turn
- Rotate 90° CCW to rotate counterclockwise by a quarter-turn
- Flip Horizontal to flip horizontally, along the vertical axis
- Flip Vertical to flip vertically, along the horizontal axis

Note: If you are transforming a shape or entire path, the Transform command becomes the Transform Path command. If you are transforming multiple path segments (but not the entire path), the Transform command becomes the Transform Points command.

Repeat a transformation

❖ Choose Edit > Transform > Again, Edit > Transform Path > Again, or Edit > Transform Points > Again.

Duplicate an item when transforming it

❖ Hold down Alt (Windows) or Option (Mac OS) when selecting the Transform command.



Transform freely

The Free Transform command lets you apply transformations (rotate, scale, skew, distort, and perspective) in one continuous operation. You can also apply a warp transformation. Instead of choosing different commands, you simply hold down a key on your keyboard to switch between transformation types.





Note: If you are transforming a shape or entire path, the Transform command becomes the Transform Path command. If you are transforming multiple path segments (but not the entire path), the Transform command becomes the Transform Points command.

1 Select what you want to transform.

2 Do one of the following:



- Choose Edit > Free Transform.
- If you are transforming a selection, pixel-based layer, or selection border, choose the Move tool . Then select Show Transform Controls in the options bar.
- If you are transforming a vector shape or path, select the Path Selection tool . Then select Show Transform Controls in the options bar.

3 Do one or more of the following:

- To scale by dragging, drag a handle. Press Shift as you drag a corner handle to scale proportionately.
- To scale numerically, enter percentages in the Width and Height text boxes in the options bar. Click the Link icon  to maintain the aspect ratio.
- To rotate by dragging, move the pointer outside the bounding border (it becomes a curved, two-sided arrow), and then drag. Press Shift to constrain the rotation to 15° increments.
- To rotate numerically, enter degrees in the rotation text box  in the options bar.
- To distort relative to the center point of the bounding border, press Alt (Windows) or Option (Mac OS), and drag a handle.
- To distort freely, press Ctrl (Windows) or Command (Mac OS), and drag a handle.
- To skew, press Ctrl+Shift (Windows) or Command+Shift (Mac OS), and drag a side handle. When positioned over a side handle, the pointer becomes a white arrowhead with a small double arrow.
- To skew numerically, enter degrees in the H (horizontal skew) and V (vertical skew) text boxes in the options bar.
- To apply perspective, press Ctrl+Alt+Shift (Windows) or Command+Option+Shift (Mac OS), and drag a corner handle. When positioned over a corner handle, the pointer becomes a gray arrowhead.
- To warp, click the Switch Between Free Transform And Warp Modes button  in the options bar. Drag control points to manipulate the shape of the item or choose a warp style from the Warp pop-up menu in the options bar. After choosing from the Warp pop-up menu, a square handle is available for adjusting the shape of the warp.
- To change the reference point, click a square on the reference point locator  in the options bar.
- To move an item, enter values for the new location of the reference in the X (horizontal position) and Y (vertical position) text boxes in the options bar. Click the Relative Positioning button  to specify the new position in relation to the current position.

 To undo the last handle adjustment, choose Edit > Undo.

4 Do one of the following:

- Press Enter (Windows) or Return (Mac OS), click the Commit button  in the options bar, or double-click inside the transformation marquee.
- To cancel the transformation, press Esc or click the Cancel button  in the options bar.

Important: When you transform a bitmap image (versus a shape or path), the image becomes slightly less sharp each time you commit a transformation; therefore, performing multiple commands before applying the cumulative transformation is preferable to applying each transformation separately.

Warp an item

The Warp command lets you drag control points to manipulate the shape of images, shapes, or paths, and so on. You can also warp using a shape in the Warp Style pop-up menu in the options bar. Shapes in the Warp Style pop-up menu are also malleable; drag their control points.

When using the control points to distort an item, choosing View > Extras shows or hides the warp mesh and control points.

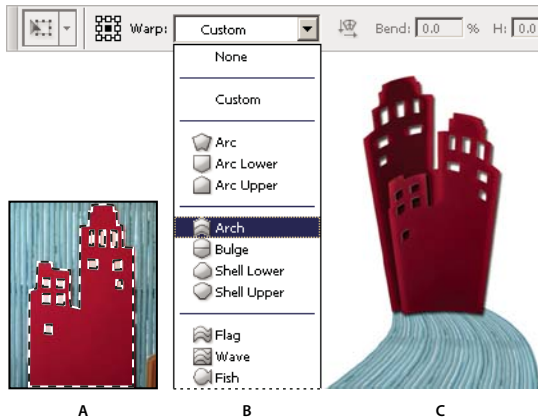

Using Warp

A. Selecting the shape to be warped **B.** Choosing a warp from the Warp Style pop-up menu in the options bar **C.** Result using several warp options

- 1 Select what you want to warp.
- 2 Do one of the following:
 - Choose Edit > Transform > Warp.
 - If you chose a different transform command or the Free Transform command, click the Switch Between Free Transform And Warp Modes button  in the options bar.
- 3 Do one or more of the following:
 - To warp using a specific shape, choose a warp style from the Warp pop-up menu in the options bar.

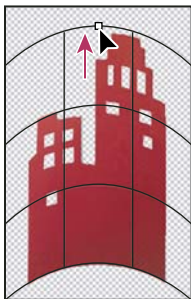



Dragging a control point to warp the mesh

- To manipulate the shape, drag the control points, a segment of the bounding box or mesh, or an area within the mesh. When adjusting a curve, use the control point handles. This is similar to adjusting the handles in the curved segment of a vector graphic.

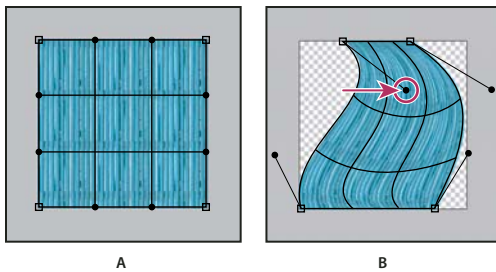

 *To undo the last handle adjustment, choose Edit > Undo.*



Manipulating the shape of a warp
A. Original warp mesh B. Adjusting the handles, mesh segments, and areas within the mesh

- To change the orientation of a warp style that you chose from the Warp menu, click the Change The Warp Orientation button  in the options bar.
- To change the reference point, click a square on the Reference point locator  in the options bar.
- To specify the amount of warp using numeric values, enter the values in the Bend (set bend), X (set horizontal distortion) and Y (set vertical distortion) text boxes in the options bar. You can't enter numeric values if you have chosen None or Custom from the Warp Style pop-up menu.

4 Do one of the following:

- Press Enter (Windows) or Return (Mac OS), or click the Commit button  in the options bar.
- To cancel the transformation, press Esc or click the Cancel button  in the options bar.

Important: When you warp a bitmap image (versus a shape or path), the image becomes slightly less sharp each time you commit a transformation; therefore, performing multiple commands before applying the cumulative transformation is preferable to applying each transformation separately.

Content-aware scaling

Resize images and protect content

Content-Aware Scale resizes an image without changing important visual content such as people, buildings, animals, and so forth. While normal scaling affects all pixels uniformly when resizing an image, content-aware scaling mostly affects pixels in areas that don't have important visual content. Content-Aware Scale lets you upscale or downscale images to improve a composition, fit a layout, or change the orientation. If you want to use some normal scaling when resizing your image, there is an option for specifying a ratio of content-aware scaling to normal scaling.

If you want to preserve specific areas when scaling an image, Content-Aware Scale lets you use an alpha channel to protect content during resizing.

Content-Aware Scaling works on layers and selections. Images can be in RGB, CMYK, Lab, and Grayscale color modes as well as all bit depths. Content-Aware Scaling doesn't work on adjustment layers, layer masks, individual channels, Smart Objects, 3D layers, Video layers, multiple layers simultaneously, or layer groups.





A. Original image B. Scaled narrower C. Scaled narrower, using content-aware scaling

For a video on using Auto-Align and Auto-Blend to create a panorama or increase depth of field, and using content-aware scaling, see www.adobe.com/go/lrvid4120_ps.

Preserve visual content when scaling images

- 1 (Optional) Choose Select > All if you're scaling a Background layer.
- 2 Choose Edit > Content-Aware Scale.
- 3 Specify any of the following in the options bar:

Reference Point Location  Click a square on the reference point locator  to specify the fixed point around which the image is scaled. By default this point is at the center of the image.

Use Relative Positioning For Reference Point  Click the button to specify the new position of the reference point in relation to its current position.



Reference Point Position Positions the reference point at the specific location. Enter X-axis and Y-axis pixel dimensions.

Scaling Percentage Specifies the image scaling as a percentage of the original size. Enter a percentage for the width (W) and height (H). If desired, click Maintain Aspect Ratio .

Amount Specifies the ratio of content-aware scaling to normal scaling. Specify a percentage for content-aware scaling by typing in the text box or clicking the arrow and moving the slider.

Protect Chooses an alpha channel that specifies an area to protect.

Protect Skin Tones  Attempts to preserve regions that contain skin-tones.

- 4 Drag a handle on the bounding box to scale the image. Press Shift as you drag a corner handle to scale proportionately. When positioned over a handle, the pointer becomes a double arrow.
- 5 Click either Cancel Transform  or Commit Transform .

Specify content to protect when scaling

- 1 Make a selection around the content you want to protect and then, in the Channels panel, click Save Selection As Channel .
- 2 (Optional) Choose Select > All if you're scaling a Background layer.
- 3 Choose Edit > Content-Aware Scale.
- 4 In the options bar, choose the alpha channel you created.

- 5 Drag a handle on the bounding border to scale the image.

Liquify filter

Liquify filter overview

The Liquify filter lets you push, pull, rotate, reflect, pucker, and bloat any area of an image. The distortions you create can be subtle or drastic, which makes the Liquify command a powerful tool for retouching images as well as creating artistic effects. The Liquify filter can be applied to 8-bits-per-channel or 16-bits per-channel images.



Distorting an image using the Liquify filter

Tools, options, and an image preview for the Liquify filter are available in the Liquify dialog box. To display the dialog box, choose Filter > Liquify.

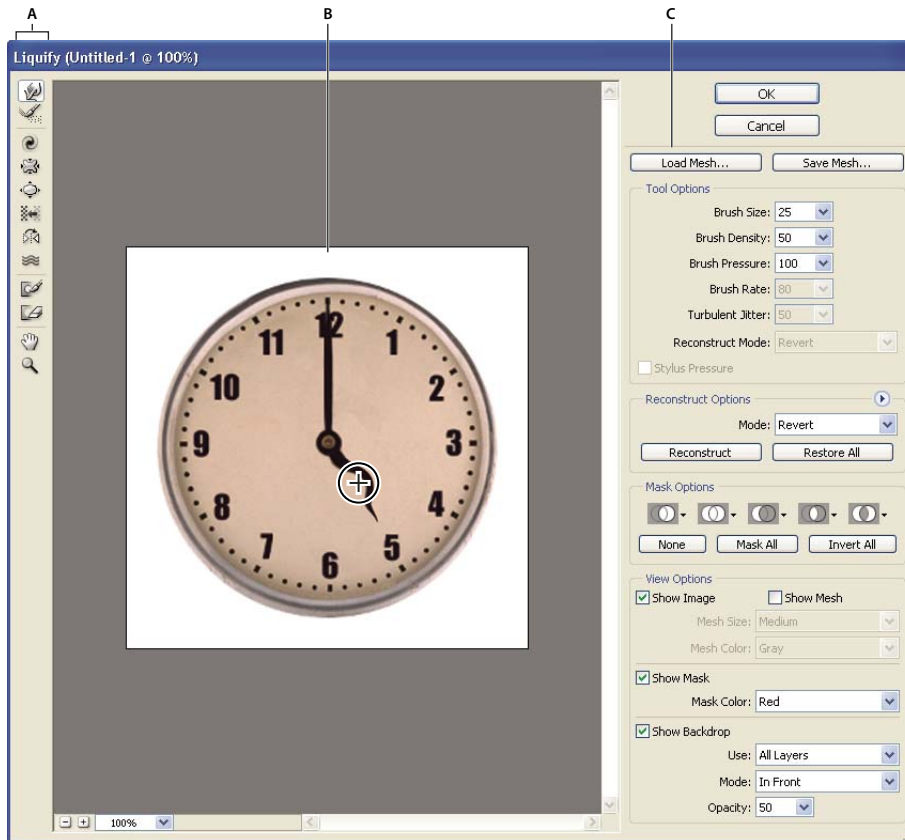

Liquify dialog box
A. Toolbox B. Preview image C. Options

Magnify or reduce the preview image

- ❖ Select the Zoom tool in the Liquify dialog box, and click or drag in the preview image to zoom in; hold down Alt (Windows) or Option (Mac OS), and click or drag in the preview image to zoom out. Alternatively, you can specify a magnification level in the Zoom text box at the bottom of the dialog box.

Navigate in the preview image

- ❖ Select the Hand tool in the Liquify dialog box, and drag in the preview image. Alternatively, hold down the spacebar with any tool selected, and drag in the preview image.

Distortion tools

Several tools in the Liquify dialog box distort the brush area when you hold down the mouse button or drag. The distortion is concentrated at the center of the brush area, and the effect intensifies as you hold down the mouse button or repeatedly drag over an area.

Forward Warp tool  Pushes pixels forward as you drag.

 *Shift-click with the Warp tool, the Push Left tool, or the Mirror tool to create the effect of dragging in a straight line from the previous point you clicked.*

Reconstruct tool Reverses the distortion you've already added, as you hold down the mouse button and drag.

Twirl Clockwise tool  Rotates pixels clockwise as you hold down the mouse button or drag. To twirl pixels counterclockwise, hold down Alt (Windows) or Option (Mac OS) as you hold down the mouse button or drag.

Pucker tool  Moves pixels toward the center of the brush area as you hold down the mouse button or drag.

Bloat tool  Moves pixels away from the center of the brush area as you hold down the mouse button or drag.

Push Left tool  Moves pixels to the left when you drag the tool straight up (pixels move to the right if you drag down). You can also drag clockwise around an object to increase its size, or drag counterclockwise to decrease its size. To push pixels right when you drag straight up (or to move pixels left when you drag down), hold down Alt (Windows) or Option (Mac OS) as you drag.

Mirror tool  Copies pixels to the brush area. Drag to mirror the area perpendicular to the direction of the stroke (to the left of the stroke). Alt-drag (Windows) or Option-drag (Mac OS) to mirror the area in the direction opposite to that of the stroke (for example, the area above a downward stroke). Usually, Alt-dragging or Option-dragging gives better results when you have frozen the area you want to reflect. Use overlapping strokes to create an effect similar to a reflection in water.

Turbulence tool  Smoothly scrambles pixels. It is useful for creating fire, clouds, waves, and similar effects.

Liquify tool options

In the tool options area of the dialog box, set the following options:

Brush Size Sets the width of the brush you'll use to distort the image.

Brush Pressure Sets the speed at which distortions are made when you drag a tool in the preview image. Using a low brush pressure makes changes occur more slowly, so it's easier to stop them at exactly the right moment.

Brush Rate Sets the speed at which distortions are applied when you keep a tool (such as the Twirl tool) stationary in the preview image. The higher the setting, the greater the speed at which distortions are applied.

Brush Density Controls how a brush feathers at the edge. An effect is strongest in the center of the brush and lighter at the edge.

Turbulent Jitter Control how tightly the Turbulence tool scrambles pixels.

Reconstruct Mode Used for the Reconstruct tool, the mode you choose determines how the tool reconstructs an area of the preview image.

Stylus Pressure Uses pressure readings from a stylus tablet. (This option is available only when you are working with a stylus tablet.) When selected, the brush pressure for the tools is the stylus pressure multiplied by the Brush Pressure value.

Distort an image

Note: If a type layer or a shape layer is selected, you must rasterize the layer before proceeding, making the type or shape editable by the Liquify filter. To distort type without rasterizing the type layer, use the Warp options for the Type tool.

- 1 Select the layer you want to distort. To change only part of the current layer, select that area.
- 2 Choose Filter > Liquify.
- 3 Freeze areas of the image that you don't want to alter.
- 4 Choose any of the liquify tools to distort the preview image. Drag in the preview image to distort the image.
- 5 After distorting the preview image, you can use the Reconstruct tool  or other controls to fully or partially reverse the changes or to change the image in new ways.

6 Do one of the following:

- Click OK to close the Liquify dialog box and apply the changes to the active layer.
- Click Cancel to close the Liquify dialog box without applying changes to the layer.
- Click Restore All to revert all distortions to the preview image, leaving all options in their current settings.
- Hold down Alt (Windows) or Option (Mac OS) and click Reset to revert all distortions to the preview image and reset all options to their defaults.

 You can use the *Edit > Fade* command to create additional effects.

See also

“[Blend and fade filter effects](#)” on page 387

Freeze and thaw areas

You can freeze areas that you don’t want to modify, thaw frozen areas, and invert frozen and thawed areas.

Freeze areas

By freezing areas of the preview image, you protect those areas from changes. Frozen areas are covered by a mask that you paint using the Freeze Mask tool . You can also use an existing mask, selection, or transparency to freeze areas. You can view the mask in the preview image to help you apply distortions.

You can use the icons’ pop-up menus in the Mask Options area of the Liquify dialog box to choose how the frozen, or masked, areas of the preview image work.

Using the Freeze Mask tool Select the Freeze Mask tool  and drag over the area you want to protect. Shift-click to freeze in a straight line between the current point and the previously clicked point.

Using a selection, mask, or transparency channel Choose Selection, Layer Mask, Transparency, or Quick Mask from the pop-up menu of any the five options in the Mask Options area of the dialog box.

Freezing all thawed areas Click the Mask All button in the Mask Options area of the dialog box.

Inverting thawed and frozen areas Click Invert All in the Mask Options area of the dialog box.

Showing or hiding frozen areas Select or deselect Show Mask in the View Options area of the dialog box.

Changing the color of frozen areas Choose a color from the Mask Color pop-up menu in the View Options area of the dialog box.

Mask options with the Liquify filter

When you have an existing selection or mask in an image, that information is retained when the Liquify dialog box opens. You can choose one of the following mask options:

Replace Selection  Shows the selection, mask, or transparency in the original image.

Add To Selection  Shows the mask in the original image, so that you can add to the selection using the Freeze Mask tool. Adds selected pixels in channel to the current frozen area.

Subtract From Selection  Subtracts pixels in channel from the current frozen area.

Intersect With Selection  Uses only pixels that are selected and currently frozen.

Invert Selection  Uses selected pixels to invert the current frozen area.

Thaw areas

❖ Do any of the following:

- Select the Thaw Mask tool , and drag over the area. Shift-click to thaw in a straight line between the current point and the previously clicked point.
- To thaw all frozen areas, click the None button in the Mask Options area of the dialog box.
- To invert frozen and thawed areas, click Invert All in the Mask Options area of the dialog box.

Reconstruct distortions

After you distort the preview image, you can use a variety of controls and reconstruction modes to reverse changes or redo the changes in new ways. Reconstructions can be applied two ways. You can apply a reconstruction to the entire image, smoothing out the distortion in unfrozen areas, or you can use the reconstruction tool to reconstruct specific areas. If you want to prevent reconstruction of distorted areas, you can use the Freeze Mask tool.

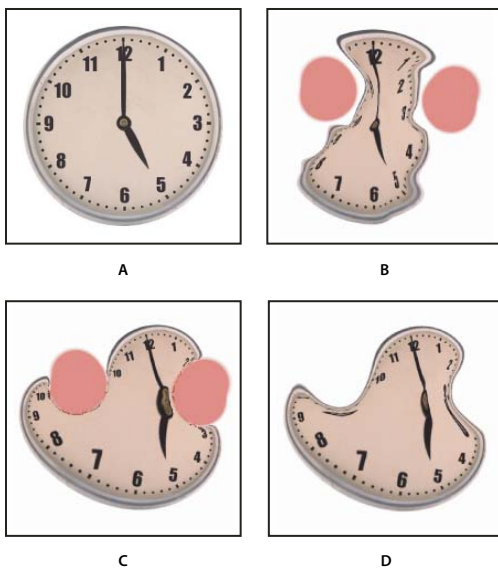

Reconstruction based on distortions in frozen areas.
A. Original image B. Distorted with frozen areas C. Reconstructed in Rigid mode (using button) D. Thawed, edges reconstructed in Smooth mode (using tool)

Reconstruct an entire image

- 1 Select a reconstruction mode from the Reconstruct Options area of the dialog box.
- 2 Press the Reconstruct button in the Reconstruction Options area to apply the effect once. You can apply the reconstruction more than once to create a less distorted appearance.

Remove all distortions

❖ Click the Restore All button in the Reconstruct Option area of the dialog box. This removes distortions even in frozen areas.

Reconstruct part of a distorted image

- 1 Freeze areas you want to keep distorted.
- 2 Select the Reconstruct tool . Choose one of these Reconstruct tool modes from the Tool Options area of the dialog box.

- 3 Hold down the mouse button or drag over the area. Pixels move more quickly at the brush center. Shift-click to reconstruct in a straight line between the current point and the previously clicked point.

Repeat distortions sampled from a starting point

- 1 After distorting the preview image, choose one of these reconstruction modes from the Mode menu in the Tool Options area of the dialog box.
- 2 Select the Reconstruct tool , and in the preview image, hold down the mouse button or drag from a starting point.

This creates a copy of the distortion sampled at the starting point, much as the Clone tool does when you use it to paint a copy of an area. If there is no distortion, the effect is the same as using Revert mode. You can set new starting points and use the Reconstruct tool repeatedly to create a variety of effects.

Reconstruction modes

You can choose one of the following reconstruction modes:

Rigid Maintains right angles in the pixel grid (as shown by the mesh) at the edges between frozen and unfrozen areas, sometimes producing near-discontinuities at the edges. This restores the unfrozen areas so that they approximate their original appearance. (To restore their original appearance, use Revert reconstruction mode.)

Stiff Acts like a weak magnetic field. At the edges between frozen and unfrozen areas, the unfrozen areas take on the distortions of the frozen areas. As the distance from frozen areas increases, the distortions lessen.

Smooth Propagates the distortions in frozen areas throughout unfrozen areas, with smoothly continuous distortions.

Loose Produces effects similar to Smooth, with even greater continuity between distortions in frozen and unfrozen areas.

Revert Scales back distortions uniformly without any kind of smoothing.

Reconstruct tool modes

The Reconstruct tool has three modes that use the distortion at the point where you first clicked the tool (start point) to reconstruct the area over which you use the tool. Every time you click, you set a new start point; so, if you want to extend an effect from one start point, don't release the mouse button until you finish using the Reconstruct tool.

Displace Reconstructs unfrozen areas to match the displacement at the start point for the reconstruction. You can use Displace to move all or part of the preview image to a different location. If you click and gradually spiral out from the start point, you displace or move a portion of the image to the area you brush over.

Amplitwist Reconstructs unfrozen areas to match the displacement, rotation, and overall scaling that exist at the start point.

Affine Reconstructs unfrozen areas to match all distortions that exist at the start point, including displacement, rotation, horizontal and vertical scaling, and skew.

Work with meshes

Using a mesh helps you see and keep track of distortions. You can choose the size and color of a mesh, and save the mesh from one image and apply it to other images.

- To add a mesh, select Show Mesh in the View Options area of the dialog box, and choose a mesh size and mesh color.

- To show a mesh, select Show Mesh. When Show Mesh is selected, you can show or hide the preview image. Select Show Image in the View Options area of the dialog box to show the preview image; deselect Show Image to view only the mesh.
- To save a distortion mesh, after distorting the preview image, click Save Mesh. Specify a name and location for the mesh file, and click Save.
- To apply a distortion mesh, click Load Mesh, select the mesh file you want to apply, and click Open. If the image and distortion mesh aren't the same size, the mesh is scaled to fit the image.

Work with backdrops

You can choose to show only the active layer in the preview image, or you can show additional layers in the preview image as a backdrop. Using the Mode options, you can position the backdrop in front of or behind the active layer to keep track of your changes, or to line up a distortion with another distortion made in a different layer.

Important: *Only the active layer is distorted, even if other layers are displayed.*

Showing the backdrop Select Show Backdrop, and then choose an option from the Use pop-up menu. If you use All Layers, changes to the current target layer are not reflected in the backdrop layer. Specify an overlay opacity to change the blending between the target layer and the backdrop. The mode determines how the backdrop and the target layer are combined for the preview. Choose an option from the Mode pop-up menu.

Hiding the backdrop Deselect Show Backdrop in the View Options area of the dialog box.

Vanishing Point

About Vanishing Point

Vanishing Point simplifies perspective-correct editing in images that contain perspective planes—for example, the sides of a building, walls, floors, or any rectangular object. In Vanishing Point, you specify the planes in an image, and then apply edits such as painting, cloning, copying or pasting, and transforming. All your edits honor the perspective of the plane you're working in. When you retouch, add, or remove content in an image, the results are more realistic because the edits are properly oriented and scaled to the perspective planes. After you finish working in Vanishing Point, you can continue editing the image in Photoshop. To preserve the perspective plane information in an image, save your document in PSD, TIFF, or JPEG format.



Making edits on the perspective planes in an image

Photoshop Extended users can also measure objects in an image, and export 3D information and measurements to DXF and 3DS formats for use in 3D applications.

For a video on using Vanishing Point, see www.adobe.com/go/vid0019.

See also

[Using Vanishing Point video](#)

Vanishing Point dialog box overview

The Vanishing Point dialog box (Filter > Vanishing Point) contains tools for defining the perspective planes, tools for editing the image, a measure tool (Photoshop Extended only), and an image preview. The Vanishing Point tools (Marquee, Stamp, Brush, and others) behave similarly to their counterparts in the main Photoshop toolbox. You can use the same keyboard shortcuts to set the tool options. Opening the Vanishing Point menu  displays additional tool settings and commands.

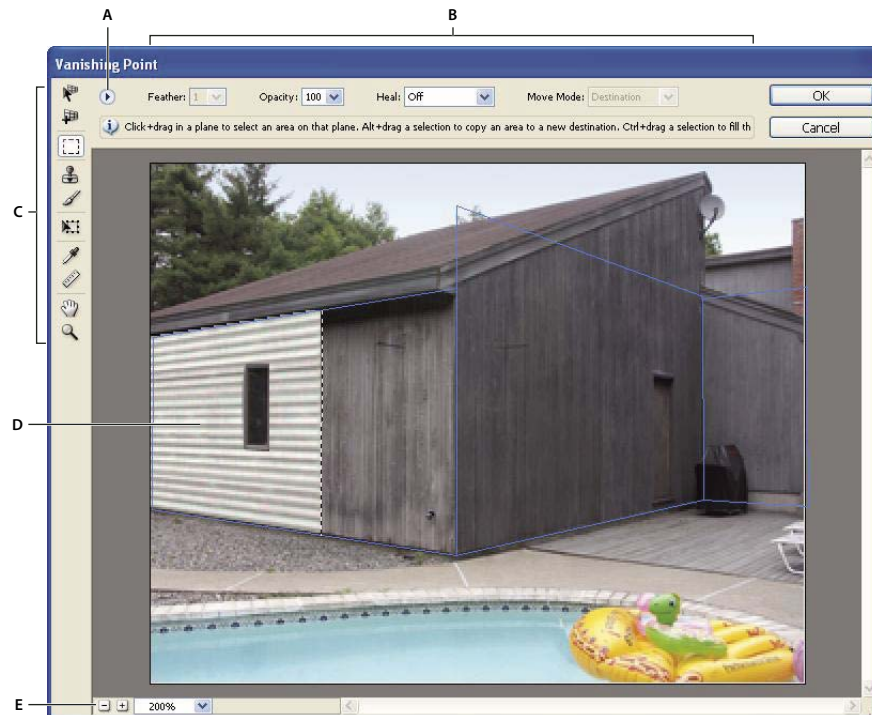

Vanishing Point dialog box
A. Vanishing Point menu B. Options C. Toolbox D. Preview of vanishing point session E. Zoom options

Vanishing Point tools

Vanishing Point tools behave like their counterparts in the main Photoshop toolbox. You can use the same keyboard shortcuts for setting tool options. Selecting a tool changes the available options in the Vanishing Point dialog box.

Edit Plane tool  Selects, edits, moves, and resizes planes.

Create Plane tool  Defines the four corner nodes of a plane, adjusts the size and shape of the plane, and tears off a new plane.

Marquee tool Makes square or rectangular selections, and also moves or clones selections.

 *Double-clicking the Marquee tool in a plane selects the entire plane.*

Stamp tool  Paints with a sample of the image. Unlike the Clone Stamp tool, the Stamp tool in Vanishing Point can't clone elements from another image. See also "[Paint with sampled pixels in Vanishing Point](#)" on page 240 and "[Retouch with the Clone Stamp tool](#)" on page 197.

Brush tool  Paints a selected color in a plane.

Transform tool  Scales, rotates, and moves a *floating selection* by moving the bounding box handles. Its behavior is similar to using the Free Transform command on a rectangle selection. See also "[Transform freely](#)" on page 217.

Eyedropper tool  Selects a color for painting when you click in the preview image.

Measure tool  Measures distances and angles of an item in a plane. See also “[Measure in Vanishing Point](#)” on page 240

Zoom tool  Magnifies or reduces the view of the image in the preview window.

Hand tool Moves the image in the preview window.

Magnify or reduce the preview image

- ❖ Do any of the following:
 - Select the Zoom tool  in the Vanishing Point dialog box, and click or drag in the preview image to zoom in; hold down Alt (Windows) or Option (Mac OS), and click or drag to zoom out.
 - Specify a magnification level in the Zoom text box at the bottom of the dialog box.
 - Click the Plus sign (+) or Minus sign (-) button to zoom in or out, respectively.
 - To temporarily zoom into the preview image, hold down the “x” key. This is especially helpful for placing the corner nodes when defining a plane, and for working on details.

Move the image in the preview window.

- ❖ Do any of the following:
 - Select the Hand tool in the Vanishing Point dialog box, and drag in the preview image.
 - Hold down the spacebar with any tool selected, and drag in the preview image.

Work in Vanishing Point

1. (Optional) Prepare your image for work in Vanishing Point.

Before choosing the Vanishing Point command, do any of the following:

- To place the results of your Vanishing Point work in a separate layer, first create a new layer before choosing the Vanishing Point command. Placing the Vanishing Point results in a separate layer preserves your original image and you can use the layer opacity control, styles, and blending modes.
- If you plan to clone the content in your image beyond the boundaries of the current image size, increase the canvas size to accommodate the additional content. See also “[Change the canvas size](#)” on page 196
- If you plan to paste an item from the Photoshop clipboard into Vanishing Point, copy the item before choosing the Vanishing Point command. The copied item can be from a different Photoshop document. If you’re copying type, select the entire text layer and then copy to the clipboard.
- To confine the Vanishing Point results to specific areas of your image, either make a selection or add a mask to your image before choosing the Vanishing Point command. See also “[Select with the marquee tools](#)” on page 248 and “[About masks and alpha channels](#)” on page 269.
- To copy something in perspective from one Photoshop document to another, first copy the item while in Vanishing Point in one document. When you paste the item in another document while in Vanishing Point, the item’s perspective is preserved.

2. Choose Filter > Vanishing Point.

3. Define the four corner nodes of the plane surface.

By default, the Create Plane tool  is selected. Click in the preview image to define the corner nodes. Try to use a rectangle object in the image as a guide when creating the plane.



Defining the four corner nodes with the Create Plane tool

To tear off additional planes, use the Create Plane tool and Ctrl-drag (Windows) or Command-drag (Mac OS) an edge node.

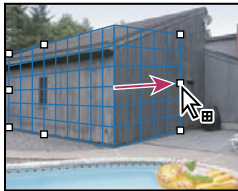

Ctrl-drag (Windows) or Command-drag (Mac OS) an edge node to tear off a plane.

For more information, see “[Define and adjust perspective planes in Vanishing Point](#)” on page 232.

4. Edit the image.

Do any of the following:

- Make a selection. Once drawn, a selection can be cloned, moved, rotated, scaled, filled, or transformed. For detailed information, see “[About selections in Vanishing Point](#)” on page 234.
- Paste an item from the clipboard. The pasted item becomes a *floating selection*, which conforms to the perspective of any plane that it’s moved into. For detailed information, see also “[Paste an item into Vanishing Point](#)” on page 238.
- Paint with color or sampled pixels. For detailed information, see “[Paint with a color in Vanishing Point](#)” on page 239 or “[Paint with sampled pixels in Vanishing Point](#)” on page 240.
- Scale, rotate, flip, flop, or move a floating selection. For detailed information, see “[About selections in Vanishing Point](#)” on page 234.
- Measure an item in a plane. Measurements can be rendered in Photoshop by choosing Render Measurements To Photoshop from the Vanishing Point menu. For detailed information, see “[Measure in Vanishing Point](#)” on page 240.

5. (Photoshop Extended only) Export 3D information and measurements to DXF or 3DS format.

Textures are also exported to 3DS format. For detailed information, see “[Export measurements, textures, and 3D information](#)” on page 242.

6. Click OK.

Grids can be rendered to Photoshop by choosing Render Grids To Photoshop from the Vanishing Point menu before you click OK. For detailed information, see “Render grids to Photoshop” on page 242.

See also

“Keys for using Vanishing Point” on page 657

About perspective planes and the grid

Before you can make edits in Vanishing Point, you define rectangular planes that line up with the perspective in an image. The accuracy of the plane determines whether any edits or adjustments are properly scaled and oriented in your image.

After you establish the four corner nodes, the perspective plane is active and displays a bounding box and a grid. You can scale, move, or reshape to fine-tune the perspective plane. You can also change the grid size so it lines up with elements in the image. Sometimes, lining up the bounding box and grid with a texture or pattern in your image helps you accurately match the image’s perspective. Adjusting the grid size can also make it easier for you to count items in the image.

Besides helping to line up the perspective planes with image elements, the grid is helpful for visualizing measurements when used with the Measure tool. An option is available to link the grid size to measurements you make with the Measure tool.

See also

“Measure in Vanishing Point” on page 240

Define and adjust perspective planes in Vanishing Point

- 1 In the Vanishing Point dialog box, select the Create Plane tool  and click in the preview image to add the four corner nodes.

Try to use a rectangular object or a plane area in the image as a guide when creating the perspective plane. To help with node placement, hold down the “x” key to zoom into the preview image. As you add corner nodes, you can delete the last node if it’s not correct by pressing the Backspace key (Windows) or Delete key (Mac OS). You can also reposition a node by dragging it.

- 2 Select the Edit Plane tool  and do one or more of the following:
 - To reshape the perspective plane, drag a corner node.
 - To adjust the grid, enter a value in the Grid Size text box or click the down arrow and move the slider. You can also adjust the grid size when the Create Plane tool is selected.
 - To move the plane, click inside the plane and drag.
 - To scale the plane, drag an edge node in a segment of the bounding box.

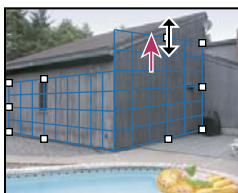

Dragging an edge node to increase the size of a plane to accommodate your edits

The bounding box and grid of a perspective plane is normally blue. If there's a problem with the placement of the corner nodes, the plane is invalid, and the bounding box and grid turn either red or yellow. When your plane is invalid, move the corner nodes until the bounding box and grid are blue.

 *If you have overlapping planes, Ctrl-click (Windows) or Command-click (Mac OS) to cycle through the overlapping planes.*

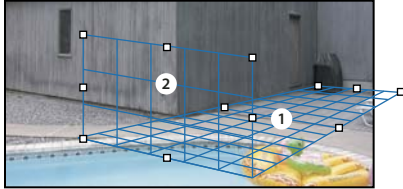

Overlapping planes

Create related perspective planes

After creating a plane in Vanishing Point, you can create (tear off) additional planes that share the same perspective. Once a second plane is torn off from the initial perspective plane, you can tear off additional planes from the second plane and so forth. You can tear off as many planes as you want. Although new planes tear off at 90° angles, you can adjust them to any angle. This is useful for making seamless edits between surfaces, matching the geometry of a complex scene. For example, corner cabinets in a kitchen can be part of a continuous surface. In addition to adjusting the angles of a related perspective plane, you can always resize the plane using the Edit Plane tool.

- 1 Select the Create Plane tool or Edit Plane tool and Ctrl-drag (Windows) or Command-drag (Mac OS) an edge node of an existing plane's bounding box (not a corner node).

The new plane is torn off at a 90° angle to the original plane.

Note: *If a newly created plane does not properly line up with the image, select the Edit Plane tool and move a corner node to adjust the plane. When you adjust one plane, all the connected planes are affected.*

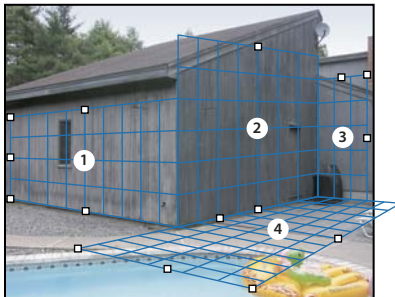

Tearing off multiple planes keeps the planes related to each other so your edits are scaled and oriented in the proper perspective.

- 2 (Optional) Do one of the following to change the angle of the newly torn off plane:
 - With either the Edit Plane tool or Create Plane tool selected, Alt-drag (Windows) or Option-drag (Mac OS) the center edge node on the side that's opposite from the axis of rotation.
 - Enter a value in the Angle text box.
 - Move the Angle slider.

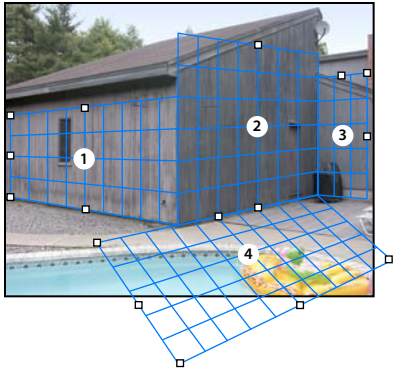

Changed plane angle.

Note: Once you create a new (child) plane from an existing (parent) plane, you can no longer adjust the angle of the parent plane.

Bounding box and grid alerts in Vanishing Point

The bounding box and grid change colors to indicate the plane's current condition. If your plane is invalid, move a corner node until the bounding box and grid are blue.

Blue Indicates a valid plane. Keep in mind that a valid plane doesn't guarantee results with the proper perspective. You must make sure that the bounding box and grid accurately line up with geometric elements or a plane area in the image.

Red Indicates an invalid plane. Vanishing Point cannot calculate the plane's aspect ratio. You won't be able to tear off a perpendicular plane from a red invalid plane. Although it's possible to make edits in a (red) invalid plane, the results will not be oriented properly.

Yellow Indicates an invalid plane. All the vanishing points of the plane cannot be resolved. Although it's possible to tear off a perpendicular plane or make edits in a yellow invalid plane, the results will not be oriented properly.



Show or hide the grid, active selections, and perspective plane boundaries

❖ Choose Show Edges from the Vanishing Point menu.

Note: Selections temporarily show when they are resized or repositioned even if Show Edges is turned off.

Adjust the spacing of the perspective plane grid

❖ Do any of the following:

- Select the Edit Plane  or the Create Plane  tool, and then enter a Grid Size value in the tool options area.
- (Photoshop Extended only) Select the Measure tool  and then select Link Measurements To Grid in the tool options area. Drag the Measure tool in a plane and enter a Length value in the tool options area.

About selections in Vanishing Point

Selections can be helpful when you're painting or retouching to correct flaws, add elements, or enhance an image. In Vanishing Point, making selections let you paint or fill specific areas in an image while honoring the perspective defined by the planes in the image. Selections can also be used to clone and move specific image content in perspective.

Using the Marquee tool in Vanishing Point, you draw a selection within a perspective plane. If you draw a selection that spans more than one plane, it wraps to conform to the perspective of each plane.

Once a selection is drawn, you can move it anywhere in the image and maintain the perspective established by the plane. If your image has multiple planes, the selection conforms to the perspective of the plane it's moved through.

Vanishing Point also lets you clone the image pixels in a selection as it is moved in an image. In Vanishing Point, a selection containing image pixels that you can move anywhere in the image is called a *floating selection*. Although not on a separate layer, the pixels in a floating selection seem to be a separate layer hovering above the main image. While active, a floating selection can be moved, rotated, or scaled.

Note: When you paste an item into Vanishing Point, the pasted pixels are in a floating selection.

Clicking outside a floating selection deselects it. Once deselected, a floating selection's content is pasted into the image, replacing the pixels that were below it. Cloning a copy of a floating selection also deselects the original.

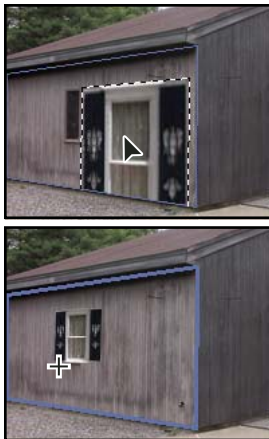

Pasted item in Vanishing Point.

Vanishing Point has another move option for selections. You can fill the selection with pixels from the area where the pointer is moved.

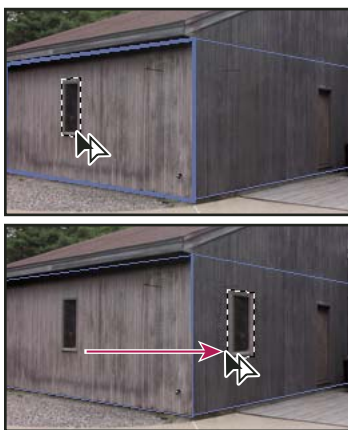

Copying a selection and moving a selection from one perspective plane to another

See also

[“Fill selections with another area of an image”](#) on page 237

[“Copy selections in Vanishing Point”](#) on page 238

[“Define and adjust perspective planes in Vanishing Point”](#) on page 232

Make selections in Vanishing Point

- 1 Select the Marquee tool.
- 2 (Optional) In the tool options area, enter values for any of the following settings before making the selection:

Feather Specifies how much to blur the edges of the selection.

Opacity Specify this value if you plan to use the selection to move image content. This option determines how much the moved pixels obscure or reveal the image underneath.

Heal menu Choose a blending mode if you plan to use a selection to move image content. This option determines how the moved pixels blend with the surrounding image:

- Choose Off so the selection doesn't blend with the colors, shadows, and textures of the surrounding pixels.
 - Choose Luminance to blend the selection with the lighting of the surrounding pixels.
 - Choose On to blend the selection with the color, lighting, and shading of surrounding pixels.
- 3 Drag the tool in a plane. You can make a selection that spans more than one plane. Hold the Shift key to constrain the selection to a square that's in perspective.

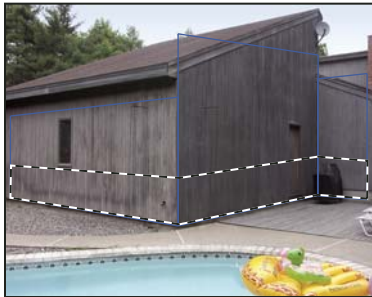

Selection spanning more than one plane

Note: To select an entire plane, double-click the Marquee tool in the plane.

Move selections in Vanishing Point

- 1 Make a selection in a perspective plane.
- 2 Choose one of the following from the Move Mode menu to determine the behavior when you move a selection:
 - To select the area you move the selection marquee to, choose Destination.
 - To fill the selection with the image pixels in the area where you drag the Selection tool pointer to (same as Ctrl-dragging or Command-dragging a selection), choose Source.
- 3 Drag the selection. Hold down the Shift key to constrain the move so it is aligned with the grid of the perspective plane.

Move, rotate and scale floating selections

- ❖ Do any of the following:
 - To move a floating selection, select the Marquee or Transform tool, click inside the selection and drag.
 - To rotate a floating selection, select the Transform tool and move the pointer near a node. When the pointer changes to a curved double arrow, drag to rotate the selection. You can also select the Flip option to flip the selection horizontally along the vertical axis of the plane or select the Flop option to flip the selection vertically along the horizontal axis of the plane.

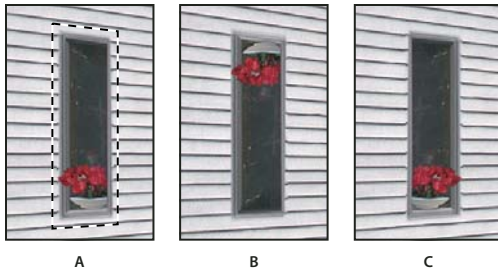

Transform tool options

A. Original selection B. Flop C. Flip

- To scale a floating selection, make sure that it is in a perspective plane. Select the Transform tool and move the pointer on top of a node. When the pointer changes to a straight double arrow drag to scale the selection. Press the Shift key to constrain the aspect ratio as you scale. Press Alt (Windows) or Option (Mac OS) to scale from the center.

Fill selections with another area of an image

- 1 Make a selection in a perspective plane.
- 2 (Optional) Move the selection where you want it. Make sure the Move Mode is set to Destination, when you move the selection.
- 3 Do one of the following:
 - Ctrl-drag (Windows) or Command-drag (Mac OS) the pointer from inside the selection to the image area that you want to fill the selection.
 - Choose Source from the Move Mode menu and drag the pointer from inside the selection to the image area that you want to fill the selection.

The filled selection becomes a floating selection that you can scale, rotate, move, or clone using the Transform tool, or move or clone using the Marquee tool.

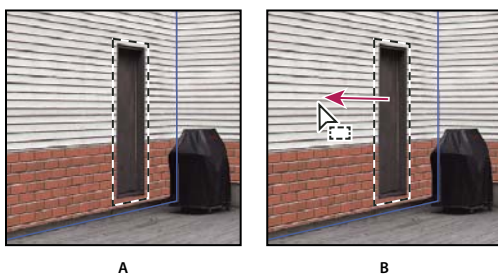

A

B

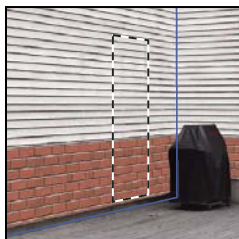

C

Ctrl-dragging (Windows) or Command-dragging (Mac OS) a selection

A. Original selection B. Moving the selection to the source image C. The source image fills the original selection

See also

“About selections in Vanishing Point” on page 234

Copy selections in Vanishing Point

- 1 Make a selection in a perspective plane.
- 2 Alt-drag (Windows) or Option-drag (Mac OS) the selection with the Marquee tool to create a copy of the selection and its image pixels.

The copy becomes a *floating selection*, which seems to hover above the main image. You can move a floating selection, or you can select the Transform tool to scale or rotate the floating selection.

- 3 Do one of the following:
 - Click outside the floating selection to deselect it. The selection’s content is pasted into the image, replacing the pixels that were below it.
 - Click in the floating selection with either the Marquee or Transform tool and Alt-drag (Windows) or Option-drag (Mac OS) to make another copy. Once copied, the original floating selection is deselected and replaces the pixels that were below it.

 Pressing Control+Shift+T (Windows) or Command+Shift+T (Mac OS) duplicates your last duplicating move. This is an easy way to clone content multiple times.

See also

“About selections in Vanishing Point” on page 234

Paste an item into Vanishing Point

You can paste an item from the clipboard in Vanishing Point. The copied item can be from the same document or a different one. Once pasted into Vanishing Point, the item becomes a floating selection that you can scale, rotate, move or clone. When the floating selection moves into a selected plane, it conforms to the plane’s perspective.

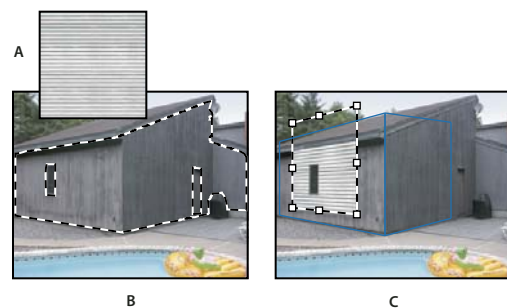

Pasting an item into Vanishing Point
A. Copied pattern from a separate document **B.** Image with selection (to confine results) created in Photoshop before opening Vanishing Point
C. Pasted pattern in Vanishing Point is moved into the plane and honors the selection

 For convenience, it’s recommended that you create perspective planes in a previous Vanishing Point session.

- 1 Copy an item to the clipboard. The copied item can be from the same or different document. Keep in mind that you can paste only a raster (not vector) item.

Note: If you’re copying type, select the entire text layer and then copy to the clipboard. You’ll be pasting a rasterized version of the type into Vanishing Point.

- 2 (Optional) Create a new layer.
- 3 Choose Filter > Vanishing Point.
- 4 If necessary, create one or more planes in the image.
- 5 Press Ctrl-V (Windows) or Command-V (Mac OS) to paste the item.

The pasted item is now a floating selection in the upper left corner of the preview image. By default, the Marquee tool is selected.

- 6 Use the Marquee tool to drag the pasted image to a plane.

The image conforms to the perspective of the plane.

Important: After pasting the image in Vanishing Point, do not click anywhere in the image with the Marquee tool except to drag the pasted image to a perspective plane. Clicking anywhere else deselects the floating selection and permanently pastes the pixels into the image.

Paint with a color in Vanishing Point

- 1 Select the Brush tool.
- 2 Specify a brush color by doing one of the following:
 - Select the Eyedropper tool and click a color in the preview image.
 - Click the Brush Color box to open the Color Picker to select a color.
- 3 In the tool options area, set the Diameter (brush size), Hardness (the amount of anti-aliasing on the brush), and Opacity (the degree that the painting obscures or reveals the image beneath it).
- 4 Choose a Healing mode:
 - To paint without blending with the color, lighting, and shading of the surrounding pixels, choose Off.
 - To paint and blend the strokes with the lighting of the surrounding pixels while retaining the selected color, choose Luminance.
 - To paint and blend with the colors, lighting, and shading of the surrounding pixels, choose On.
- 5 (Optional) Specify the paint application options:
 - To paint continuously, automatically conforming to the perspective from one plane to another, open the Vanishing Point menu and choose Allow Multi-Surface Operations. Turning this option off lets you paint in the perspective of one plane at a time. You need to stop and then start painting in a different plane to switch perspective.
 - To confine painting to the active plane only, open the Vanishing Point menu and choose Clip Operations To Surface Edges. Turning this option off lets you paint in perspective beyond the boundaries of the active plane.
- 6 Drag in the image to paint. When painting in a plane, the brush size and shape scales and orients properly to the plane's perspective. Shift-drag constrains the stroke to a straight line that conforms to the plane's perspective. You can also click a point with the Brush tool and then Shift-click another point to paint a straight line in perspective.



The Brush tool honors marquee selections and can be used to paint a hard line along the edge of the selection. For example, if you select an entire plane, you can paint a line along the perimeter of the plane.

Paint with sampled pixels in Vanishing Point

In Vanishing Point, the Stamp tool paints with sampled pixels. The cloned image is oriented to the perspective of the plane you're painting in. The Stamp tool is useful for such tasks as blending and retouching image areas, cloning portions of a surface to "paint out" an object, or cloning an image area to duplicate an object or extend a texture or pattern.

- 1 In Vanishing Point, select the Stamp tool .
- 2 In the tool options area, set the Diameter (brush size), Hardness (the amount of anti-aliasing on the brush), and Opacity (the degree that the painting obscures or reveals the image beneath it).
- 3 Choose a blending mode from the Heal menu:
 - To prevent the strokes from blending with the colors, shadows, and textures of the surrounding pixels, choose Off.
 - To blend the strokes with the lighting of the surrounding pixels, choose Luminance.
 - To blend the strokes with the color, lighting, and shading of surrounding pixels, choose On.
- 4 To determine the sampling behavior of the Stamp tool:
 - Select Aligned to sample pixels continuously, without losing the current sampling point even when you release the mouse button.
 - Deselect Aligned to continue using the sampled pixels from the initial sampling point each time you stop and resume painting.
- 5 (Optional) Specify the paint application options:
 - To paint continuously from one plane to another, open the Vanishing Point menu and choose Allow Multi-Surface Operations.
 - To confine painting to the active plane only, open the Vanishing Point menu and choose Clip Operations To Surface Edges.
- 6 Move the pointer into a plane and Alt-click (Windows) or Option-click (Mac OS) to set the sampling point.
- 7 Drag over the area of the image you want to paint. Hold the Shift key down to drag a straight line that conforms to the plane's perspective. You can also click a point with the Stamp tool and then Shift-click another point to paint a straight line in perspective.

Measure in Vanishing Point

(Photoshop Extended only) Users ranging from architects and interior decorators to forensic scientists and woodworkers often need to know the size of objects in an image. In Vanishing Point, the Measure tool lets you draw a measurement line over an object in a perspective plane that you know the size of. The Measure tool has an option for entering a length for the measurement. The measurement line displays two text boxes: one for the length and one showing the angle that the line was drawn relative to the perspective plane. Once the measurement and its length have been set, all subsequent measurements correctly scale to your initial measurement.

For a video on using Vanishing Point, see www.adobe.com/go/vid0019.

There's an option for linking the line's measurement length with the grid spacing of the perspective plane. For example, a measurement length of 5 causes the grid to display 5 spaces, when the link option is selected. This might be useful for visualizing sizes in the image or for counting objects in an image. When unlinked, the grid spacing can be adjusted independent of the measurement. This option is useful in such instances where you find that the grid spacing is too small and visually confusing when linked to the measurement.

The measurements you create can be rendered so they appear in the image after you close the Vanishing Point dialog box. You can also export your measurements and geometric information to formats that can be read by CAD applications.

See also

“[Keys for using Vanishing Point](#)” on page 657

Measure objects in an image

1 In Vanishing Point, select the Measure tool and then click and drag over an object in a plane.

It's best to make your initial measurement of an object that you know the size of.

Note: Once you start creating a measurement from within a plane, it's possible to continue drawing the measurement beyond the plane boundaries.

2 With a measurement selected, enter a Length value to set its measured length.

3 (Optional) Draw additional measurements.

The size of these measurements are scaled to the size of your initial measurement.

4 (Optional) Do one of the following:

- If you want the size of the grid to be independent of the Length value you assigned to the initial measurement, make sure Link Measurements To Grid is deselected. This is the default setting.
- If you want the size of the grid to adjust according to the Length value you assigned to the initial measurement, select Link Measurements To Grid.

Vanishing Point measurements in an image are preserved after closing the dialog box. They appear when you launch Vanishing Point again.

Automatically drawing a measurement in Vanishing Point

The Measure tool can automatically draw the length and width measurements of a surface that's defined by a perspective plane.

- ❖ Double-click the Measure tool in a perspective plane.

Move a measurement in Vanishing Point

In Vanishing Point, you can move a measurement line without changing its orientation (angle) or length.

1 Select the Measure tool.

2 Click anywhere along the length of an existing measurement and drag.

Change the length or orientation of a measurement

You can change the length or orientation (angle) of an existing measurement.

1 Select the Measure tool and move it over the end point of an existing measurement line.

2 Do any of the following:

- To change the orientation and length of a measurement, drag an end point.
- To change the length of a measurement and constrain its angle changes to 15 degree increments, Ctrl-drag (Windows) or Command-drag (Mac OS) an end point.

- To change the length of a measurement without changing its orientation, Alt-drag (Windows) or Option-drag (Mac OS) an end point.
- To change the orientation of a measurement without changing its length, Shift-drag an end point.

Delete a measurement in Vanishing Point

- ❖ Select a measurement and press Backspace (Windows only) or Delete.

Show or hide measurements in Vanishing Point

- ❖ Open the Vanishing Point menu and choose Show Measurements.

Render measurements in Photoshop

The Vanishing Point measurements are invisible when viewing an image in the Photoshop document window, even though the measurements are preserved in the image and appear whenever you launch Vanishing Point. Measurements can be rendered so when you finish working in Vanishing Point, they're visible in the Photoshop document window. The rendered measurements are raster not vector.

- ❖ Open the Vanishing Point menu and choose Render Measurements To Photoshop.

The Render Measurements To Photoshop command must be chosen for each Vanishing Point session.

 Create a new layer for your Vanishing Point results if you plan to render the measurements to Photoshop. This keeps the measurements on a separate layer from the main image.

Export measurements, textures, and 3D information

3D information (planes), textures, and measurements created in Vanishing Point can be exported to a format for use in CAD, modeling, animation, and special effects applications. Exporting to DXF creates a file with 3D information and any measurements. Exported 3DS files contain rendered textures in addition to the geometric information.

- 1 Open the Vanishing Point menu and choose either Export to DXF or Export To 3DS.
- 2 In the Export DXF or Export 3DS dialog box, select a location for the saved file and click Save.

Render grids to Photoshop

By default, the Vanishing Point grids are invisible when viewing an image in the Photoshop document window, even though the grids are preserved in the image and appear whenever you launch Vanishing Point. Grids can be rendered so when you finish working in Vanishing Point, they're visible in the Photoshop document window. The rendered grids are raster not vector.

- ❖ Open the Vanishing Point menu and choose Render Grids To Photoshop.

The Render Grids To Photoshop command must be chosen for each Vanishing Point session.

 Create a new layer for your Vanishing Point results if you plan to render the grids to Photoshop. This keeps the grids on a separate layer from the main image.

Create panoramic images

About Photomerge

The Photomerge™ command combines several photographs into one continuous image. For example, you can take five overlapping photographs of a city skyline, and then assemble them into a panorama. The Photomerge command can assemble photos that are tiled horizontally as well as vertically.



Source images (top), and completed Photomerge composition (bottom)

To create Photomerge compositions, choose File > Automate > Photomerge and then choose your source files and then specify layout and blending options. Your option choice depends on how you photographed the panorama. For example, if you've photographed images for a 360 degree panorama, the Spherical layout option is recommended. This option stitches the images and transforms them as if they were mapped to the inside of a sphere, which simulates the experience of viewing a 360 degree panorama.

For a video on using Photomerge, see www.adobe.com/go/vid0013.

For a video on editing and merging images from Lightroom, see www.adobe.com/go/lrvid4121_ps.

Take pictures for use with Photomerge

Your source photographs play a large role in panoramic compositions. To avoid problems, follow these guidelines when taking pictures for use with Photomerge:

Overlap images sufficiently Images should overlap by approximately 25% to 40%. If the overlap is less, Photomerge may not be able to automatically assemble the panorama. However, keep in mind that the images shouldn't overlap too much. If images overlap by 70% or more, Photomerge may not be able to blend the images. Try to keep the individual photos at least somewhat distinct from each other.

Use one focal length If you use a zoom lens, don't change the focal length (zoom in or out) while taking your pictures.

Keep the camera level Although Photomerge can process slight rotations between pictures, a tilt of more than a few degrees can result in errors when the panorama is assembled. Using a tripod with a rotating head helps maintain camera alignment and viewpoint.

Stay in the same position Try not to change your position as you take a series of photographs, so that the pictures are from the same viewpoint. Using the optical viewfinder with the camera held close to the eye helps keep the viewpoint consistent. Or try using a tripod to keep the camera in the same place.

Avoid using distortion lenses Fish-eye and other distortion lenses can interfere with Photomerge.

Note: Photoshop CS4 will support fish-eye correction when creating panoramas for images taken with fish-eye lenses. Use the Auto option in this case.

Maintain the same exposure Avoid using the flash in some pictures and not in others. The blending features in Photomerge helps smooth out different exposures, but extreme differences make alignment difficult. Some digital

cameras change exposure settings automatically as you take pictures, so you may need to check your camera settings to be sure that all the images have the same exposure.

Create a Photomerge composition

1 Do one of the following:

- Choose File > Automate > Photomerge.
- In Adobe® Bridge CS4, choose Tools > Photoshop > Photomerge from the Bridge menu bar. Skip to step 5.

Note: In Bridge, choosing the Photomerge command uses all images currently displayed in Bridge. If you only want specific images used, select them before choosing the Photomerge command.

2 Under Source Files in the Photomerge dialog box, choose one of the following from the Use menu:

Files Generates the Photomerge composition using individual files.

Folders Uses all the images stored in a folder to create the Photomerge composition.

3 Specify which images to use by doing one of the following:

- To select image files or a folder of images, click the Browse button and navigate to the files or folder.
- To use the images currently open in Photoshop, click Add Open Files.
- To remove images from the Source File list, select the file and click the Remove button.

4 Select a Layout option:

Auto Photoshop analyzes the source images and applies either a Perspective, Cylindrical, and Spherical layout, depending on which produces a better photomerge.

Perspective Creates a consistent composition by designating one of the source images (by default, the middle image) as the reference image. The other images are then transformed (repositioned, stretched or skewed as necessary) so that overlapping content across layers is matched.

Cylindrical Reduces the “bow-tie” distortion that can occur with the Perspective layout by displaying individual images as on an unfolded cylinder. Overlapping content across files is still matched. The reference image is placed at the center. Best suited for creating wide panoramas.

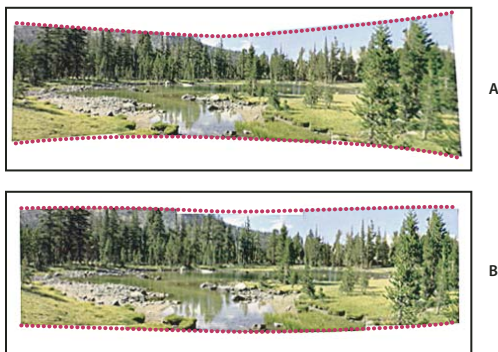

Applying Cylindrical Mapping
A. Original B. Cylindrical Mapping applied

Spherical Aligns and transforms the images as if they were for mapping the inside of a sphere. If you have taken a set of images that cover 360 degrees, use this for 360 degree panoramas. You might also use Spherical to produce nice panoramic results with other file sets.

Collage Aligns the layers and matches overlapping content and transforms (rotate or scale) any of the source layers.

Reposition Aligns the layers and matches overlapping content, but does not transform (stretch or skew) any of the source layers.

5 Select any of the following options:

Blend Images Together Finds the optimal borders between the images and create seams based on those borders, and to color match the images. With Blend Images Together turned off, a simple rectangular blend is performed. This may be preferable if you intend to retouch the blending masks by hand.

Vignette Removal Removes and performs exposure compensation in images that have darkened edges caused by lens flaws or improper lens shading.

Geometric Distortion Correction Compensates for barrel, pincushion, or fisheye distortion.

6 Click OK.

Photoshop creates one multi-layer image from the source images, adding layer masks as needed to create optimal blending where the images overlap. You can edit the layer masks or add adjustment layers to further fine tune the different areas of the panorama.

Create 360 degree panoramas

(Photoshop Extended only) You can use the 3D features to create a wrapping 360 degree panorama. First, you stitch together the images to create a panorama, and then use the Spherical Panorama command to wrap the panorama so it's continuous. You can use either the Auto-Align Layers workflow or Photomerge to stitch the panorama.

Photomerge has fewer steps. The Auto-Align Layers workflow provides more control because of the additional feedback around lens metadata and corrections as well as the ability to perform alignment and blending separately.

Be sure to photograph a “full circle” of images with sufficient overlap. Photographing with a pano head on a tripod helps produce better results when stitching the panorama.

For a video on using Auto-Align and Auto-Blend to create a panorama and increase depth of field, and using content-aware scaling, see www.adobe.com/go/lrvid4120_ps.

See also

“Create 3D shapes” on page 590

Create 360 degree panoramas using Auto-Align Layers

The following procedure only works with Adobe® Photoshop® CS4 Extended.

- 1 Choose File > Scripts > Load Files Into Stack.
- 2 In the Load Layers dialog box, choose Files or Folders from the Use menu, and then browse to locate the files you want to use. Click OK when done.

Do not include images that cover the top (zenith) or bottom (nadir) of the scene. You'll add these images later.

- 3 Select all the layers in the Layers panel and then choose Edit > Auto-Align Layers.
- 4 In the Auto-Align Layers dialog box, select either Auto or Spherical for the Projection.
- 5 (Optional) Select Vignette Removal or Geometric Distortion for the Lens Correction.

Photoshop uses the lens metadata to auto-detect if you photographed with a fisheye lens. In the case of fisheye lens detection, the Geometric Distortion Correction option is automatically selected.

6 Click OK.

7 Choose Edit > Auto-Blend Layers.

- 8 In the Auto-Blend Layers dialog box, select Panorama for the Blend Method, select the Seamless Tone and Colors option, and then click OK.

There might be transparent pixels on the edges of the panoramic image. These can prevent the final 360 panorama from wrapping correctly. You can either crop the pixels out or use the Offset filter to identify and remove the pixels.

- 9 Choose 3D > New Shape From Layer > Spherical Panorama.
- 10 (Optional) Manually add the top and bottom images into the sphere. You could also paint out any remaining transparent pixels in the 3D spherical panorama layer.

Create 360 degree panoramas using Photomerge

The following procedure only works with Adobe® Photoshop® CS4 Extended.

- 1 Choose File > Automate > Photomerge.
- 2 In the Photomerge dialog box, add the images you want to use.

Do not include images that cover the top (zenith) or bottom (nadir) of the scene. You'll add these images later.

- 3 Select Spherical for the Layout.

If you photographed with a fisheye lens, it's recommended that you select Auto for the Layout and also select the Geometric Distortion Correction option.

- 4 (Optional) Select Vignette Removal or Geometric Distortion for the Lens Correction.
- 5 Click OK.

There might be transparent pixels on the edges of the panoramic image. These can prevent the final 360 panorama from wrapping correctly. You can either crop the pixels out or use the Offset filter to identify and remove the pixels.

- 6 Choose 3D > New Shape From Layer > Spherical Panorama.
- 7 (Optional) Manually add the top and bottom images into the sphere. You could also paint out any remaining transparent pixels in the 3D spherical panorama layer.

Chapter 9: Selecting and masking

If you want to apply changes to parts of an image, you first need to select the pixels that make up those parts. You select pixels in Adobe Photoshop CS4 using the selection tools or by painting on a mask and loading the mask as a selection. To select and work with vector objects in Photoshop, you use the pen selection and shape tools. This chapter covers pixel selection tools and techniques.

Making selections

About selecting pixels

A *selection* isolates one or more parts of your image. By selecting specific areas, you can edit and apply effects and filters to portions of your image while leaving the unselected areas untouched.

Photoshop provides separate sets of tools to make selections of raster and vector data. For example, to select pixels, you can use the marquee tools or the lasso tools. You can use commands in the Select menu to select all pixels, to deselect, or to reselect.

To select vector data, you can use the pen or shape tools, which produce precise outlines called *paths*. You can convert paths to selections or convert selections to paths.

Selections can be copied, moved, and pasted, or saved and stored in an *alpha channel*. Alpha channels store selections as grayscale images called *masks*. A mask is like the inverse of a selection: it covers the unselected part of the image and protects it from any editing or manipulations you apply. You can convert a stored mask back into a selection by loading the alpha channel into an image.

Note: To select a specific color or a range of colors within an entire image or within a selected area, you can use the *Color Range* command.

See also

[“About masks and alpha channels”](#) on page 269

[“Create and edit alpha channel masks”](#) on page 273

[“Convert paths to selection borders”](#) on page 380

[“Selection tools gallery”](#) on page 20

Select, deselect, and reselect pixels

You can select all visible pixels on a layer or deselect any selected pixels.



If a tool is not working as expected, you may have a hidden selection. Use the Deselect command and try the tool again.

Select all pixels on a layer within the canvas boundaries

- 1 Select the layer in the Layers panel.
- 2 Choose Select > All.

Deselect selections

- ❖ Do one of the following:
 - Choose Select > Deselect.
 - If you are using the Rectangle Marquee tool, the Elliptical Marquee tool, or the Lasso tool, click anywhere in the image outside the selected area.

Reselect the most recent selection

- ❖ Choose Select > Reselect.



Select with the marquee tools

The marquee tools let you select rectangles, ellipses, and 1-pixel rows and columns.

- 1 Select a marquee tool:

Rectangular Marquee  Makes a rectangular selection (or a square, when used with the Shift key).

Elliptical Marquee  Makes an elliptical selection (or a circle, when used with the Shift key).

Single Row  **or Single Column**  **Marquee** Defines the border as a 1-pixel-wide row or column.

- 2 Specify one of the selection options in the options bar.

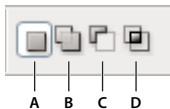

Selection options

A. New B. Add To C. Subtract From D. Intersect With

- 3 Specify a feathering setting in the options bar. Turn anti-aliasing on or off for the Elliptical Marquee tool. See “[Soften the edges of selections](#)” on page 259.

- 4 For the Rectangle Marquee tool or the Elliptical Marquee tool, choose a style in the options bar:

Normal Determines marquee proportions by dragging.

Fixed Ratio Sets a height-to-width ratio. Enter values (decimal values are valid) for the aspect ratio. For example, to draw a marquee twice as wide as it is high, enter 2 for the width and 1 for the height.

Fixed Size Specifies set values for the marquee’s height and width. Enter pixel values in whole numbers.

 *In addition to pixels (px) you can also use specific units such as inches (in) or centimeters (cm) in height and width values.*

- 5 For aligning your selection to guides, a grid, slices, or document bounds, do one of the following to snap your selection:
 - Choose View > Snap, or choose View > Snap To and choose a command from the submenu. The marquee selection can snap to a document boundary or to a variety of Photoshop Extras, controlled in the Snap To submenu.
- 6 Do one of the following to make a selection:
 - With the Rectangle Marquee tool or the Elliptical Marquee tool, drag over the area you want to select.
 - Hold down Shift as you drag to constrain the marquee to a square or circle (release the mouse button before you release Shift to keep the selection shape constrained).
 - To drag a marquee from its center, hold down Alt (Windows) or Option (Mac OS) after you begin dragging.

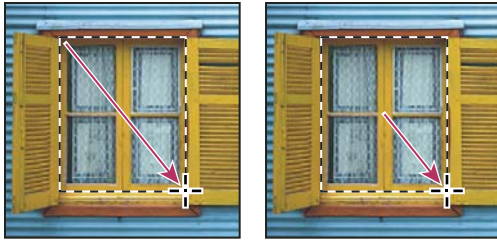

Dragging a marquee from the corner of an image (left), and from the center of an image (right) by pressing Alt/Option as you drag

- With the Single Row or Single Column Marquee tool, click near the area you want to select, and then drag the marquee to the exact location. If no marquee is visible, increase the magnification of your image view.

 *To reposition a rectangle or elliptical marquee, first drag to create the selection border, keeping the mouse button depressed. Then hold down the spacebar and continue to drag. Release the spacebar, but keep the mouse button depressed, if you need to continue adjusting the selection border.*

Select with the Lasso tool

The Lasso tool is useful for drawing freeform segments of a selection border.

- 1 Select the Lasso tool , and select options.
- 2 Drag to draw a freehand selection border.
- 3 Specify one of the selection options in the options bar.

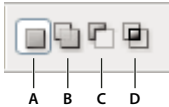

Selection options

A. New B. Add To C. Subtract From D. Intersect With

- 4 (Optional) Set feathering and anti-aliasing in the options bar. See “[Soften the edges of selections](#)” on page 259.
- 5 To draw a straight-edged selection border when no other pixels are selected, press Alt (Windows) or Option (Mac OS), and click where segments should begin and end. You can switch between drawing freehand and straight-edged segments.
- 6 To erase recently drawn segments, hold down the Delete key until you’ve erased the fastening points for the desired segment.
- 7 To close the selection border, release the mouse without holding down Alt (Windows) or Option (Mac OS).
- 8 (Optional) Click Refine Edge to further adjust the selection boundary or view the selection against different backgrounds or as a mask. See “[Refine selection edges](#)” on page 258.

Select with the Polygonal Lasso tool

The Polygonal Lasso tool is useful for drawing straight-edged segments of a selection border.

- 1 Select the Polygonal Lasso tool , and select options.
- 2 Specify one of the selection options in the options bar.

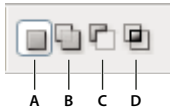



Selection options

A. New **B.** Add To **C.** Subtract From **D.** Intersect With

- 3 (Optional) Set feathering and anti-aliasing in the options bar. See “[Soften the edges of selections](#)” on page 259.
- 4 Click in the image to set the starting point.
- 5 Do one or more of the following:
 - To draw a straight segment, position the pointer where you want the first straight segment to end, and click. Continue clicking to set endpoints for subsequent segments.
 - To draw a straight line at a multiple of 45°, hold down Shift as you move to click the next segment.
 - To draw a freehand segment, hold down Alt (Windows) or Option (Mac OS), and drag. When you finish, release Alt or Option and the mouse button.
 - To erase recently drawn straight segments, press the Delete key.
- 6 Close the selection border:
 - Position the Polygonal Lasso tool pointer over the starting point (a closed circle appears next to the pointer), and click.
 - If the pointer is not over the starting point, double-click the Polygonal Lasso tool pointer, or Ctrl-click (Windows) or Command-click (Mac OS).
- 7 (Optional) Click Refine Edge to further adjust the selection boundary or view the selection against different backgrounds or as a mask. See “[Refine selection edges](#)” on page 258.

Select with the Magnetic Lasso tool

When you use the Magnetic Lasso tool , the border snaps to the edges of defined areas in the image. The Magnetic Lasso tool is not available for 32-bits-per-channel images.

 *The Magnetic Lasso tool is especially useful for quickly selecting objects with complex edges set against high-contrast backgrounds.*

- 1 Select the Magnetic Lasso tool.
- 2 Specify one of the selection options in the options bar.

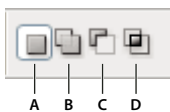

Selection options

A. New **B.** Add To **C.** Subtract From **D.** Intersect With

- 3 (Optional) Set feathering and anti-aliasing in the options bar. See “[Soften the edges of selections](#)” on page 259.
- 4 Set any of these options:

Width To specify a detection width, enter a pixel value for Width. The Magnetic Lasso tool detects edges only within the specified distance from the pointer.

 To change the lasso pointer so that it indicates the lasso width, press the Caps Lock key. You can change the pointer while the tool is selected but not in use. Press the right bracket (]) to increase the Magnetic Lasso edge width by 1 pixel; press the left bracket ([) to decrease the width by 1 pixel.

Contrast To specify the lasso's sensitivity to edges in the image, enter a value between 1% and 100% for Contrast. A higher value detects only edges that contrast sharply with their surroundings; a lower value detects lower-contrast edges.

Frequency To specify the rate at which the lasso sets fastening points, enter a value between 0 and 100 for Frequency. A higher value anchors the selection border in place more quickly.

 On an image with well-defined edges, try a higher width and higher edge contrast, and trace the border roughly. On an image with softer edges, try a lower width and lower edge contrast, and trace the border more precisely.

Stylus Pressure If you are working with a stylus tablet, select or deselect the Stylus Pressure option. When the option is selected, an increase in stylus pressure decreases the edge width.

- 5 Click in the image to set the first fastening point. Fastening points anchor the selection border in place.
- 6 To draw a freehand segment, either release or keep the mouse button depressed, and then move the pointer along the edge you want to trace.

The most recent segment of the selection border remains active. As you move the pointer, the active segment snaps to the strongest edge in the image, based on the detection width set in the options bar. Periodically, the Magnetic Lasso tool adds fastening points to the selection border to anchor previous segments.

- 7 If the border doesn't snap to the desired edge, click once to add a fastening point manually. Continue to trace the edge, and add fastening points as needed.

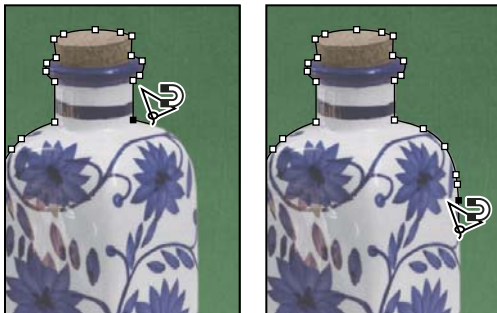



Fastening points anchor selection border to edges

- 8 To switch temporarily to the other lasso tools, do one of the following:
 - To activate the Lasso tool, hold down Alt (Windows) or Option (Mac OS), and drag with the mouse button depressed.
 - To activate the Polygonal Lasso tool, hold down Alt (Windows) or Option (Mac OS), and click.
- 9 To erase recently drawn segments and fastening points, press the Delete key until you've erased the fastening points for the desired segment.
- 10 Close the selection border:
 - To close the border with a freehand Magnetic segment, double-click, or press Enter or Return.
 - To close the border with a straight segment, hold down Alt (Windows) or Option (Mac OS), and double-click.
 - To close the border, drag back over the starting point and click.

11 (Optional) Click Refine Edge to further adjust the selection boundary or view the selection against different backgrounds or as a mask. See “[Refine selection edges](#)” on page 258.

Select with the Quick Selection tool

You can use the Quick Selection tool  to quickly “paint” a selection using an adjustable round brush tip. As you drag, the selection expands outward and automatically finds and follows defined edges in the image.

- 1 Select the Quick Selection tool .
- 2 In the options bar, click one of the selection options: New, Add To, or Subtract From.

New is the default option if nothing is selected. After making the initial selection, the option changes automatically to Add to.

- 3 To change the Quick Selection tool brush tip size, click the Brush menu in the options bar and type in a pixel size or move the Diameter slider. Use the Size pop-up menu options to make the brush tip size sensitive to pen pressure or a stylus wheel.

 When creating a selection, press the right bracket (]) to increase the Quick Selection tool brush tip size; press the left bracket ([) to decrease the brush tip size.

- 4 Choose Quick Selection options.

Sample All Layers Creates a selection based on all layers instead of just the currently selected layer.

Auto-Enhance Reduces roughness and blockiness in the selection boundary. Auto-Enhance automatically flows the selection further toward image edges and applies some of the edge refinement you can apply manually in the Refine Edge dialog with the Smooth, Contrast, and Radius options.

- 5 Paint inside the part of the image you want to select.

The selection grows as you paint. If updating is slow, continue to drag to allow time to complete work on the selection. As you paint near the edges of a shape, the selection area extends to follow the contours of the shape edge.

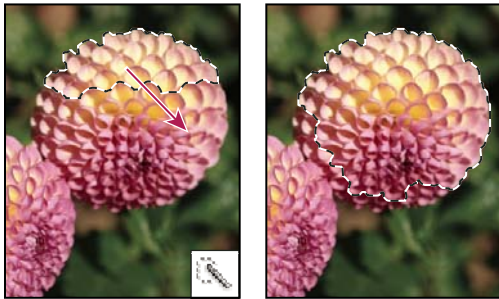

Painting with the Quick Selection tool to extend the selection

 If you stop dragging and then click or drag in a nearby area, the selection will grow to include the new area.

- To subtract from a selection, click the Subtract from option in the options bar, then drag over the existing selection.
- To temporarily switch between add and subtract modes, hold down the Alt (Windows) or Option (Mac) key.
- To change the tool cursor, choose Edit > Preferences > Cursors > Painting Cursors (Windows) or Photoshop > Preferences > Cursors > Painting Cursors (Mac OS). Normal Brush Tip displays the standard Quick Selection cursor with a plus or minus sign to show the selection mode.

- 6 (Optional) Click Refine Edge to further adjust the selection boundary or view the selection against different backgrounds or as a mask. See “[Refine selection edges](#)” on page 258.

Select with the Magic Wand tool

The Magic Wand tool lets you select a consistently colored area (for example, a red flower) without having to trace its outline. You specify the color range, or *tolerance*, for the Magic Wand tool’s selection, based on similarity to the pixel you click.

 You cannot use the Magic Wand tool on an image in Bitmap mode or on 32-bits-per-channel images.

- 1 Select the Magic Wand tool .
- 2 Specify one of the selection options in the options bar. The Magic Wand tool’s pointer changes depending on which option is selected.

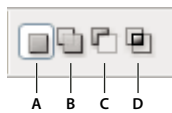

Selection options

A. New B. Add To C. Subtract From D. Intersect With

- 3 In the options bar, specify any of the following:

Tolerance Determines the similarity or difference of the pixels selected. Enter a value in pixels, ranging from 0 to 255. A low value selects the few colors very similar to the pixel you click. A higher value selects a broader range of colors.

Anti-aliased Creates a smoother-edged selection.

Contiguous Selects only adjacent areas using the same colors. Otherwise, all pixels in the entire image using the same colors are selected.

Sample All Layers Selects colors using data from all the visible layers. Otherwise, the Magic Wand tool selects colors from the active layer only.

- 4 In the image, click the color you want to select. If Contiguous is selected, all adjacent pixels within the tolerance range are selected. Otherwise, all pixels in the tolerance range are selected.
- 5 (Optional) Click Refine Edge to further adjust the selection boundary or view the selection against different backgrounds or as a mask. See “[Refine selection edges](#)” on page 258.

Select a color range

The Color Range command selects a specified color or color range within an existing selection or an entire image. If you want to replace a selection, be sure to deselect everything before applying this command. The Color Range command is not available for 32-bits-per-channel images.

To refine an existing selection, use the Color Range command repeatedly to select a subset of colors. For example, to select the green areas in a cyan selection, select Cyans in the Color Range dialog box, and click OK. Then reopen the Color Range dialog box, and select Greens. (The results are subtle because this technique selects parts of colors within a color mix.)

- 1 Choose Select > Color Range.

 You can also use Color Range to refine a layer mask. See “[Change mask opacity or refine edges](#)” on page 321.

2 Choose the Sampled Colors tool from the Select menu.

You can also choose a color or tonal range from the Select menu, but you won't be able to adjust the selection. The Out-Of-Gamut option works only on RGB and Lab images. (An out-of-gamut color is an RGB or Lab color that cannot be printed using process color printing.)

If you are selecting multiple color ranges in the image, select Localized Color Clusters to build a more accurate selection.

3 Select one of the display options:

Selection Previews the selection that will result from the colors you sample in the image. White areas are selected pixels, black areas are unselected, and gray areas are partially selected.

Image Previews the entire image. For example, you might want to sample from a part of the image that isn't on-screen.

 To toggle between the Image and Selection previews in the Color Range dialog box, press Ctrl (Windows) or Command (Mac OS).

4 Position the Eyedropper pointer over the image or preview area, and click to sample the colors you want included.

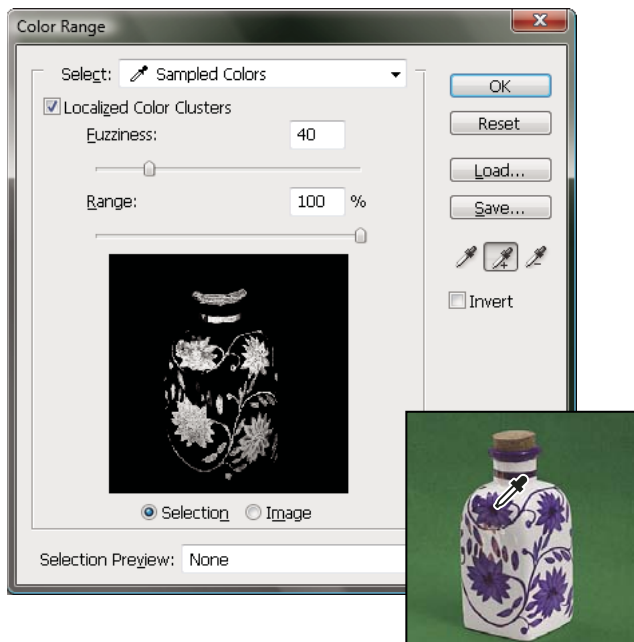

Sampling color

5 Adjust the range of colors selected using the Fuzziness slider or by entering a value. The Fuzziness setting controls how wide a range of colors is in the selection, and increases or decreases the amount of partially selected pixels (gray areas in the selection preview). Set a low Fuzziness value to restrict the color range, a higher value to increase the range.



Increasing fuzziness expands selection

If you selected Localized Color Clusters, use the Range slider to control how far or near a color must be from the sample points to be included in the selection. For example, your image contains a patch of yellow flowers in both the foreground and the background, but you want to select just the foreground flowers. Sample the colors in the foreground flowers and reduce the Range so that the similarly colored flowers in the background are not selected.

6 Adjust the selection:

- To add colors, select the plus eyedropper, and click in the preview area or image.
- To remove colors, select the minus eyedropper, and click in the preview area or image.

 *To activate the plus eyedropper temporarily, hold down Shift. Hold down Alt (Windows) or Option (Mac OS) to activate the minus eyedropper.*

7 To preview the selection in the image window, choose an option for Selection Preview.

8 To revert to the original selection, hold down Alt (Windows) or Option (Mac OS), and click Reset.

9 To save and load color range settings, use the Save and Load buttons in the Color Range dialog box to save and reuse the current settings.

Note: *If you see the message “No pixels are more than 50% selected,” the selection border will not be visible. You may have picked a color choice from the Select menu, such as Reds, when the image didn’t contain any red hues with high enough saturation.*

For a video on making selections, see www.adobe.com/go/vid0002.

Adjusting pixel selections

Move, hide, or invert a selection

You can move a selection border around an image, hide a selection border, and invert a selection so that the previously unselected part of the image is selected.



Note: *To move the selection itself, not the selection border, use the Move tool. See “Move a selection” on page 261.*

See also

“Apply transformations” on page 214

“Show or hide Extras” on page 40

Move a selection border

1 Using any selection tool, select New Selection  from the options bar, and position the pointer inside the selection border. The pointer changes  to indicate that you can move the selection.

- 2 Drag the border to enclose a different area of the image. You can drag a selection border partly beyond the canvas boundaries. When you drag it back, the original border reappears intact. You can also drag the selection border to another image window.

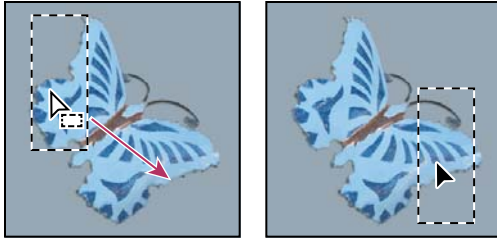

Original selection border (left), and selection border moved (right)

 You can apply geometric transformations to change the shape of a selection border.

Control the movement of a selection

- To constrain the direction to multiples of 45°, begin dragging, and then hold down Shift as you continue to drag.
- To move the selection in 1-pixel increments, use an arrow key.
- To move the selection in 10-pixel increments, hold down Shift, and use an arrow key.

Hide or show selection edges

Do one of the following:

- Choose View > Extras. This command shows or hides selection edges, grids, guides, target paths, slices, annotations, layer borders, count, and smart guide.
- Choose View > Show > Selection Edges. This toggles the view of the selection edges and affects the current selection only. The selection edges reappear when you make a different selection.

Select the unselected parts of an image

- ❖ Choose Select > Inverse.

 You can use this option to select an object placed against a solid-colored background. Select the background using the Magic Wand tool and then inverse the selection.

Adjust selections manually

You can use the selection tools to add to or subtract from existing pixel selections.

Before manually adding to or subtracting from a selection, you may want to set the feather and anti-aliasing values in the options bar to the same settings used in the original selection.

Add to a selection or select an additional area

- 1 Make a selection.
- 2 Using any selection tool, do one of the following:
 - Select the Add To Selection option  in the options bar, and drag to add to the selection.
 - Hold down Shift, and drag to add to the selection.

A plus sign appears next to the pointer when you're adding to a selection.

Subtract from a selection

- 1 Make a selection.
- 2 Using any selection tool, do one of the following:
 - Select the Subtract From Selection option  in the options bar, and drag to intersect with other selections.
 - Hold down Alt (Windows) or Option (Mac OS), and drag to subtract another selection.

A minus sign appears next to the pointer when you're subtracting from a selection.

Select only an area intersected by other selections

- 1 Make a selection.
- 2 Using any selection tool, do one of the following:
 - Select the Intersect With Selection option  in the options bar, and drag.
 - Hold down Alt+Shift (Windows) or Option+Shift (Mac OS) and drag over the portion of the original selection that you want to select.

An "x" appears next to the pointer when you're selecting an intersected area.

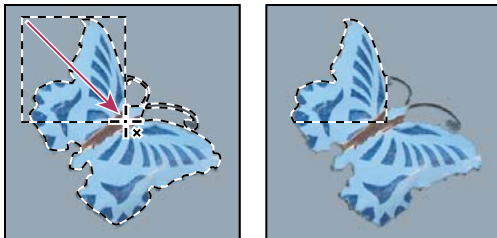

Intersected selections

Expand or contract a selection by a specific number of pixels

- 1 Use a selection tool to make a selection.
- 2 Choose Select > Modify > Expand or Contract.
- 3 For Expand By or Contract By, enter a pixel value between 1 and 100, and click OK.

The border is increased or decreased by the specified number of pixels. Any portion of the selection border running along the canvas's edge is unaffected.

Create a selection around a selection border

The Border command lets you select a width of pixels inside and outside an existing selection border. This can be useful when you need to select a border or band of pixels around an image area, rather than the area itself, for example to clean up a halo effect around a pasted object.

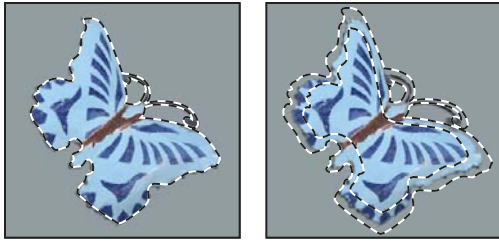

Original selection (left), and after Border command: 5 pixels (right)

- 1 Use a selection tool to make a selection.
- 2 Choose Select > Modify > Border.
- 3 Enter a value between 1 and 200 pixels for the border width of the new selection, and click OK.

The new selection frames the original selected area, and is centered on the original selection border. For example, a border width of 20 pixels creates a new, soft-edged selection that extends 10 pixels inside the original selection border and 10 pixels outside it.

Expand a selection to include areas with similar color

Do one of the following:

- Choose Select > Grow to include all adjacent pixels falling within the tolerance range specified in the Magic Wand options.
- Choose Select > Similar to include pixels throughout the image, not just adjacent ones, falling within the tolerance range.

To increase the selection in increments, choose either command more than once.

Note: You cannot use the Grow and Similar commands on Bitmap mode images or 32-bits-per-channel images.

Clean up stray pixels in a color-based selection

- 1 Choose Select > Modify > Smooth.
- 2 For Sample Radius, enter a pixel value between 1 and 100, and click OK.

For each pixel in the selection, Photoshop examines the pixels around it, to the distance you specify in the radius setting. If more than half of these surrounding pixels are selected, the pixel remains in the selection, and the unselected pixels around it are added to the selection. If less than half the surrounding pixels are selected, the pixel is removed from the selection. The overall effect is to reduce patchiness and smooth sharp corners and jagged lines in the selection.

Refine selection edges

The Refine Edge option improves the quality of a selection's edges and allows you to view the selection against different backgrounds for easy editing.

 You can also use Refine Edge options to refine a layer mask. See [“Change mask opacity or refine edges”](#) on page 321.

- 1 Create a selection with any selection tool.

2 Click Refine Edge in the selection tool options bar or choose Select > Refine Edge to set options for adjusting the selection:

Radius Determines the size of the region around the selection boundary in which edge refinement occurs. Increase the radius to create a more exact selection boundary in areas with soft transitions or fine detail, such as those in short hair or fur, or blurred boundaries.

Contrast Sharpens selection edges and removes fuzzy artifacts. Increasing contrast can remove excessive noise near selection edges caused by a high Radius setting.

Smooth Reduces irregular areas (“hills and valleys”) in the selection boundary to create a smoother outline. Enter a value or move the slider from 0 to 100.

Feather Creates a soft-edged transition between the selection and its surrounding pixels. Enter a value or move the slider to define the width of the feathered edge from 0 to 250 pixels.

Contract/Expand Shrinks or enlarges the selection boundary. Enter a value or move the slider to set the amount from 0 to 100% to expand, 0 to -100% to contract. Most useful for making subtle adjustments to soft-edged selections. Shrinking the selection can help remove unwanted background colors from selection edges.

 For images where the colors of the selected object are distinct from the background, try increasing the Radius, applying Contrast to sharpen edges, then adjusting the Contract/Expand slider. For grayscale images or images where the colors of the selected object and the background are very similar, try smoothing first, then the Feather option, then Contract/Expand.

3 Click a Selection View icon to change view modes. Click Description to view information about each mode.

- Select or deselect Preview to turn edge refinement previewing on or off.
- Click the Zoom tool to zoom in or out while adjusting the selection.
- Use the Hand tool to reposition the image.

 Double-click the Quick Mask preview mode icon to change mask color or opacity.

4 To save your selection adjustments, click OK.

Soften the edges of selections

You can smooth the hard edges of a selection by anti-aliasing and by feathering.

Anti-aliasing Smooths the jagged edges of a selection by softening the color transition between edge pixels and background pixels. Because only the edge pixels change, no detail is lost. Anti-aliasing is useful when cutting, copying, and pasting selections to create composite images.

Anti-aliasing is available for the Lasso tool, the Polygonal Lasso tool, the Magnetic Lasso tool, the Elliptical Marquee tool, and the Magic Wand tool. (Select a tool to display its options bar.)

Note: You must specify this option before using these tools. After a selection is made, you cannot add anti-aliasing.

Feathering Blurs edges by building a transition boundary between the selection and its surrounding pixels. This blurring can cause some loss of detail at the edge of the selection.

You can define feathering for the Marquee tools, the Lasso tool, the Polygonal Lasso tool, or the Magnetic Lasso tool as you use the tool, or you can add feathering to an existing selection.

Note: Feathering effects become apparent only after you move, cut, copy, or fill the selection.

Select pixels using anti-aliasing

- 1 Select the Lasso tool, the Polygonal Lasso tool, the Magnetic Lasso tool, the Elliptical Marquee tool, or the Magic Wand tool.
- 2 Select Anti-aliased in the options bar.

Define a feathered edge for a selection tool

- 1 Select any of the lasso or marquee tools.
- 2 Enter a Feather value in the options bar. This value defines the width of the feathered edge and can range from 0 to 250 pixels.

Define a feathered edge for an existing selection

- 1 Choose Select > Modify > Feather.
- 2 Enter a value for the Feather Radius, and click OK.

Note: A small selection made with a large feather radius may be so faint that its edges are invisible and thus not selectable. If you see the message “No pixels are more than 50% selected,” either decrease the feather radius or increase the size of the selection. Or click OK to accept the mask at its current setting and create a selection in which you cannot see the edges.

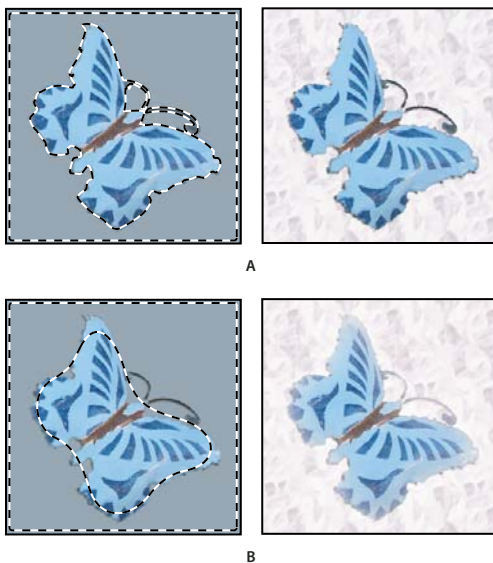

Selection without feathering and with feathering.

A. Selection with no feather, same selection filled with pattern B. Selection with feather, same selection filled with pattern

Remove fringe pixels from a selection

When you move or paste an anti-aliased selection, some of the pixels surrounding the selection border are included with the selection. This can result in a fringe or halo around the edges of the pasted selection. These Matting commands let you edit unwanted edge pixels:

- Defringe replaces the color of any fringe pixels with the color of pixels farther in from the edge of the selection that don't contain the background color.
- Remove Black Matte and Remove White Matte are useful when a selection is anti-aliased against a white or black background and you want to paste it onto a different background. For example, anti-aliased black text on a white background has gray pixels at the edges, which are visible against a colored background.

 You can also remove fringe areas by using the Advanced Blending sliders in the Layer Styles dialog box to remove, or make transparent, areas from the layer. In this case, you would make the black or white areas transparent. Alt-click (Windows) or Option-click (Mac OS) the sliders to separate them; separating the sliders allows you to remove fringe pixels and retain a smooth edge.

Decrease fringe on a selection

- 1 Choose Layer > Matting > Defringe.
- 2 Enter a value in the Width box to specify the area in which to search for replacement pixels. In most cases, a distance of 1 or 2 pixels is enough.
- 3 Click OK.

Remove a matte from a selection

- ❖ Choose Layer > Matting > Remove Black Matte or Layer > Matting > Remove White Matte.

Moving and copying selected pixels

Move a selection

- 1 Select the Move tool .
- 2 Move the pointer inside the selection border, and drag the selection to a new position. If you have selected multiple areas, all move as you drag.

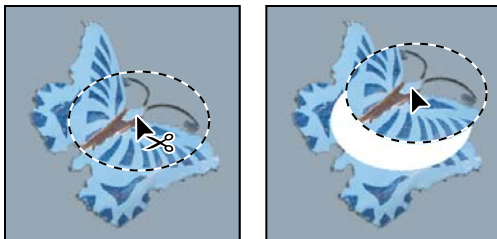

Original selection (left), and after the selection is moved with the Move tool (right)

Copy selections

You can use the Move tool to copy selections as you drag them within or between images, or you can copy and move selections using the Copy, Copy Merged, Cut, and Paste commands. Dragging with the Move tool saves memory because the clipboard is not used as it is with the Copy, Copy Merged, Cut, and Paste commands.

Copy Copies the selected area on the active layer.

Copy Merged Makes a merged copy of all the visible layers in the selected area.

Paste Pastes a cut or copied selection into another part of the image or into another image as a new layer. If you have a selection, the Paste command places the copied selection over the current selection. Without an active selection, Paste places the copied selection in the middle of the view area.

Paste Into Pastes a cut or copied selection inside another selection in the same image or a different image. The source selection is pasted onto a new layer, and the destination selection border is converted into a layer mask.

When a selection or layer is pasted between images with different resolutions, the pasted data retains its pixel dimensions. This can make the pasted portion appear out of proportion to the new image. Use the Image Size

command to make the source and destination images the same resolution before copying and pasting, or use the Free Transform command to resize the pasted content.

Depending on your color management settings and the color profile associated with the file (or imported data), you may be prompted to specify how to handle color information in the file (or imported data).

See also

“[About layer and vector masks](#)” on page 319

“[Set up color management](#)” on page 130

Copy a selection

- 1 Select the area you want to copy.
- 2 Choose Edit > Copy, or Edit > Copy Merged.

Copy a selection while dragging

- 1 Select the Move tool , or hold down Ctrl (Windows) or Command (Mac OS) to activate the Move tool.
- 2 Hold down Alt (Windows) or Option (Mac OS), and drag the selection you want to copy and move.

When copying between images, drag the selection from the active image window into the destination image window. If nothing is selected, the entire active layer is copied. As you drag the selection over another image window, a border highlights the window if you can drop the selection into it.

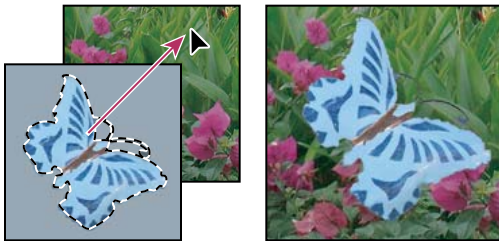

Dragging a selection into another image

Create multiple copies of a selection within an image

- 1 Select the Move tool , or hold down Ctrl (Windows) or Command (Mac OS) to activate the Move tool.
- 2 Copy the selection:
 - Hold down Alt (Windows) or Option (Mac OS), and drag the selection.
 - To copy the selection and offset the duplicate by 1 pixel, hold down Alt or Option, and press an arrow key.
 - To copy the selection and offset the duplicate by 10 pixels, press Alt+Shift (Windows) or Option+Shift (Mac OS), and press an arrow key.

As long as you hold down Alt or Option, each press of an arrow key creates a copy of the selection and offsets it by the specified distance from the last duplicate. In this case, the copy is made on the same layer.

Paste one selection into another

- 1 Cut or copy the part of the image you want to paste.
- 2 Select the part of the image into which you want to paste the selection. The source selection and the destination selection can be in the same image or in two different Photoshop images.

3 Choose Edit > Paste Into. The contents of the source selection appear within the destination selection.

The Paste Into operation adds a layer and layer mask to the image. In the Layers panel, the new layer contains a layer thumbnail for the pasted selection next to a layer mask thumbnail. The layer mask is based on the selection you pasted into: the selection is unmasked (white), the rest of the layer is masked (black). The layer and layer mask are unlinked—that is, you can move each one independently.

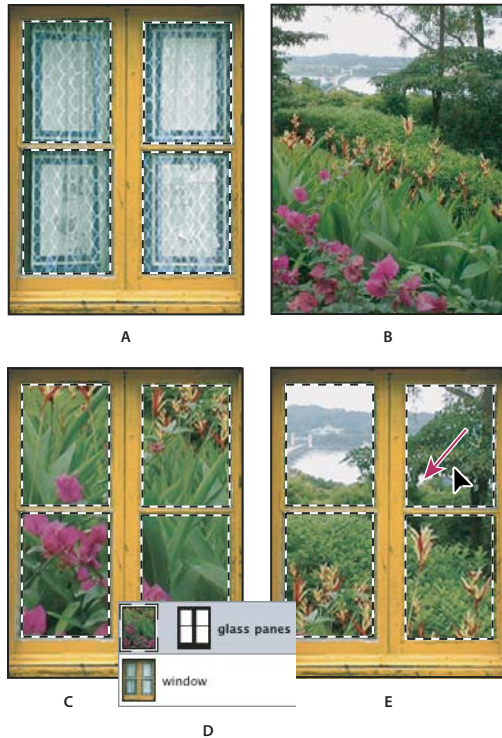

Using the Paste Into command

A. Window panes selected B. Copied image C. Paste Into command D. Layer thumbnails and layer mask in Layers panel E. Pasted image repositioned

- 4 Select the Move tool , or hold down the Ctrl (Windows) or Command (Mac OS) key to activate the Move tool. Then drag the source contents until the part you want appears through the mask.
- 5 To specify how much of the underlying image shows through, click the layer mask thumbnail in the Layers panel, select a painting tool, and edit the mask:
 - To hide more of the image underlying the layer, paint the mask with black.
 - To reveal more of the image underlying the layer, paint the mask with white.
 - To partially reveal the image underlying the layer, paint the mask with gray.
- 6 If you are satisfied with your results, you can choose Layer > Merge Down to merge the new layer and layer mask with the underlying layer and make the changes permanent.

Copy between applications

You can use the Cut, Copy, or Paste commands to copy selections from Photoshop and paste them into other applications, or to paste artwork from other applications into Photoshop. The cut or copied selection remains on the clipboard until you cut or copy another selection. You can also copy artwork between Photoshop and Illustrator by dragging and dropping.

In some cases, the contents of the clipboard are converted to a raster image. Photoshop prompts you when vector artwork will be rasterized.

Note: The image is rasterized at the resolution of the file into which you paste it. Vector Smart Objects are not rasterized.

See also

“[About Smart Objects](#)” on page 310

“[About file formats and compression](#)” on page 457

“[Remove fringe pixels from a selection](#)” on page 260

Paste PostScript artwork from another application

- 1 In the supporting application, select your artwork, and choose Edit > Copy.
- 2 Select the image into which you'll paste the selection.
- 3 Choose Edit > Paste.
- 4 In the Paste dialog box, select from the following Paste As options:

Smart Object Places the artwork in a new layer as a smart object.

Pixels Rasterizes the artwork as it is pasted. Rasterizing converts mathematically-defined vector artwork to pixels.

Paths Pastes the copy as a path in the Paths panel. When copying type from Illustrator, you must first convert it to outlines.

Shape Layer Creates a new shape layer that uses the path as a vector mask.

Note: When copying artwork from Adobe Illustrator, the default clipboard preferences in Illustrator may prevent the Paste dialog box from appearing in Photoshop. Select AICB in the File Handling and Clipboard area of the Preferences dialog box in Illustrator if you want the Paste options to appear when you paste the artwork into Photoshop.

- 5 If you chose Paste As Pixels in the previous step, you can choose Anti-aliased in the options bar to make a smooth transition between the edges of the selection and the surrounding pixels.

Note: You can use the Matting commands if you have already merged data and are trying to reextract the rasterized data.

Save clipboard contents when you quit Photoshop

- 1 Do one of the following:
 - (Windows) Choose Edit > Preferences > General.
 - (Mac OS) Choose Photoshop > Preferences > General.
- 2 Select Export Clipboard to save any Photoshop contents to the clipboard when you quit Photoshop.

Copy artwork by dragging and dropping

- ❖ Do one of the following:
 - Drag one or more Illustrator vector objects into an open image in Photoshop. This creates a vector Smart Object layer in the image. Choose Layer > Smart Objects > Edit Content to reopen the content in Illustrator for editing.
 - To copy the vector object as a path in Photoshop, hold down Ctrl (Windows) or Command (Mac OS) as you drag from Illustrator.
 - To copy the contents of the currently selected layer in Photoshop to Illustrator, use the Move tool to drag the content from the Photoshop window into an open Illustrator document.

Deleting and extracting objects

Remove (cut) an object from a photo

- 1 In the Layers panel, select the layer containing the object you want to remove.
- 2 Using a selection tool, select the object you want to remove.
- 3 If you need to refine the selection, click the Quick Mask Mode button  in the toolbox. Photoshop masks or covers the non-selected areas of the image in a translucent color. Select a brush and appropriate brush size in the options bar. Paint with black to add to the mask; paint with white to reveal more of the image.
- 4 To remove the selected object, choose Edit > Cut.

Delete selected pixels

- ❖ Choose Edit > Clear, or press Backspace (Windows) or Delete (Mac OS). To cut a selection to the clipboard, choose Edit > Cut.

Deleting a selection on a background or on a layer with the Lock Transparency option selected in the Layers panel replaces the original location with the background color. Deleting a selection on a layer without Lock Transparency selected replaces the original area with the layer transparency.

Channels

About channels

Channels are grayscale images that store different types of information:

- *Color information channels* are created automatically when you open a new image. The image's color mode determines the number of color channels created. For example, an RGB image has a channel for each color (red, green, and blue) plus a composite channel used for editing the image.
- *Alpha channels* store selections as grayscale images. You can add alpha channels to create and store masks, which let you manipulate or protect parts of an image.
- *Spot color channels* specify additional plates for printing with spot color inks.

An image can have up to 56 channels. All new channels have the same dimensions and number of pixels as the original image.

The file size required for a channel depends on the pixel information in the channel. Certain file formats, including TIFF and Photoshop formats, compress channel information and can save space. The size of an uncompressed file, including alpha channels and layers, appears as the right-most value in the status bar at the bottom of the window when you choose Document Sizes from the pop-up menu.

Note: As long as you save a file in a format supporting the image's color mode, the color channels are preserved. Alpha channels are preserved only when you save a file in Photoshop, PDF, TIFF, PSB, or raw formats. DCS 2.0 format preserves only spot channels. Saving in other formats may cause channel information to be discarded.

See also

[“About spot colors”](#) on page 491

[“About masks and alpha channels”](#) on page 269

Channels panel overview

The Channels panel lists all channels in the image—composite channel first (for RGB, CMYK, and Lab images). A thumbnail of the channel's contents appears to the left of the channel name; the thumbnail is automatically updated as you edit the channel.

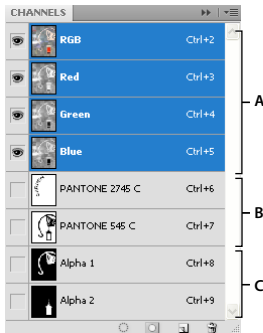

Channel types

A. Color channels B. Spot channels C. Alpha channels

Display the Channels panel

- ❖ Choose Windows > Channels.

Resize or hide channel thumbnails

- ❖ Choose Panel Options from the Channels panel menu. Click a thumbnail size or click None to turn off the display of thumbnails.

Viewing thumbnails is a convenient way of tracking channel contents; however, turning off the display of thumbnails can improve performance.

Show or hide a channel

You can use the Channels panel to view any combination of channels in the document window. For example, you can view an alpha channel and the composite channel together to see how changes made in the alpha channel relate to the entire image.

- ❖ Click in the eye column next to the channel to show or hide that channel. (Click the composite channel to view all default color channels. The composite channel is displayed whenever all the color channels are visible.)



To show or hide multiple channels, drag through the eye column in the Channels panel.

Show color channels in color

Individual channels are displayed in grayscale. In RGB, CMYK, or Lab images, you can view the individual channels in color. (In Lab images, only the *a* and *b* channels appear in color.) If more than one channel is active, the channels always appear in color.

You can change the default to show the individual color channels in color. When a channel is visible in the image, an eye icon  appears to its left in the panel.

- 1 Do one of the following:

- In Windows, choose Edit > Preferences > Interface.

- In Mac OS, choose Photoshop > Preferences > Interface.
- 2 Select Show Channels in Color, and click OK.

Select and edit channels

You can select one or more channels in the Channels panel. The names of all selected, or *active*, channels are highlighted.

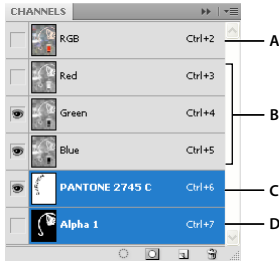

Selecting multiple channels

A. Not visible or editable B. Visible but not selected for editing C. Selected for viewing and editing D. Selected for editing but not viewing

- To select a channel, click the channel name. Shift-click to select (or deselect) multiple channels.
- To edit a channel, select it and then use a painting or editing tool to paint in the image. You can paint on only one channel at a time. Paint with white to add the selected channel's color at 100% intensity. Paint with a value of gray to add the channel's color at a lower intensity. Paint with black to fully remove the channel's color.

Rearrange and rename alpha and spot channels

You can move alpha or spot channels above the default color channels only if the image is in Multichannel mode.

- To change the order of alpha or spot channels, drag the channel up or down in the Channels panel. When a line appears in the position you want, release the mouse button.

Note: Spot colors are overprinted in the order of their appearance from top to bottom in the Channels panel.

- To rename an alpha or spot channel, double-click the channel's name in the Channels panel, and enter a new name.

See also

“Create a new spot channel” on page 491

Duplicate channels

You can copy a channel and use it in the current image or another image.

Duplicate a channel

If you are duplicating alpha channels between images, the channels must have identical pixel dimensions. You cannot duplicate a channel to a Bitmap-mode image.

- 1 In the Channels panel, select the channel to duplicate.
- 2 Choose Duplicate Channel from the Channels panel menu.
- 3 Type a name for the duplicate channel.

- 4 For Document, do one of the following:
 - Choose a destination. Only open images with pixel dimensions identical to the current image are available. To duplicate the channel in the same file, select the channel's current file.
 - Choose New to copy the channel to a new image, creating a multichannel image containing a single channel. Type a name for the new image.
- 5 To reverse the selected and masked areas in the duplicate channel, select Invert.

Duplicate a channel in an image

- 1 In the Channels panel, select the channel you want to duplicate.
- 2 Drag the channel onto the Create New Channel button  at the bottom of the panel.

Duplicate a channel in another image

- 1 In the Channels panel, select the channel you want to duplicate.
- 2 Make sure that the destination image is open.

Note: The destination image does not have to have the same pixel dimensions as the duplicated channel.

- 3 Do one of the following:
 - Drag the channel from the Channels panel into the destination image window. The duplicated channel appears at the bottom of the Channels panel.
 - Choose Select > All, and then choose Edit > Copy. Select the channel in the destination image and choose Edit > Paste. The pasted channel overwrites the existing channel.

Split channels into separate images

You can split channels of flattened images only. Splitting channels is useful when you want to retain individual channel information in a file format that doesn't preserve channels.

- ❖ To split channels into separate images, choose Split Channels from the Channels panel menu.

The original file is closed, and the individual channels appear in separate grayscale image windows. The title bars in the new windows show the original filename plus the channel. You save and edit the new images separately.

Merge channels

Multiple grayscale images can be combined as the channels of a single image. The images you want to merge must be in grayscale mode, be flattened (have no layers), have the same pixel dimensions, and be open. The number of grayscale images you have open determines the color modes available when merging channels. For example, if you have three images open, you can merge them into an RGB image; if you have four images open, they can become a CMYK image.

 *If you are working with DCS files that have accidentally lost their links (and so cannot be opened, placed, or printed), open the channel files, and merge them into a CMYK image. Then re-save the file as a DCS EPS file.*

- 1 Open the grayscale images containing the channels you want to merge, and make one of the images active.

You must have more than one image open for the Merge Channels option to be available.

- 2 Choose Merge Channels from the Channels panel menu.
- 3 For Mode, choose the color mode you want to create. The number of channels appropriate for the mode appears in the Channels text box.
- 4 If necessary, enter a number in the Channels text box.

If you enter a number that is incompatible with the selected mode, Multichannel mode is automatically selected. This creates a multichannel image with two or more channels.

5 Click OK.

6 For each channel, make sure the image you want is open. If you change your mind about the image type, click Mode to return to the Merge Channels dialog box.

7 If you are merging channels into a multichannel image, click Next, and select the remaining channels.

Note: All channels of a multichannel image are alpha channels or spot channels.

8 When you have finished selecting channels, click OK.

The selected channels are merged into a new image of the specified type, and the original images are closed without any changes. The new image appears in an untitled window.

Note: You cannot split and recombine (merge) an image with spot color channels. The spot color channel will be added as an alpha channel.

Delete a channel

You may want to delete spot or alpha channels you no longer need before saving an image. Complex alpha channels can substantially increase the disk space required for an image.

❖ In Photoshop, select the channel in the Channels panel and do one of the following:

- Alt-click (Windows) or Option-click (Mac OS) the Delete icon .
- Drag the channel name in the panel to the Delete icon.
- Choose Delete Channel from the Channels panel menu.
- Click the Delete icon at the bottom of the panel, and then click Yes.

Note: When you delete a color channel from a file with layers, visible layers are flattened and hidden layers are discarded. This is done because removing a color channel converts the image to Multichannel mode, which does not support layers. An image isn't flattened when you delete an alpha channel, a spot channel, or a quick mask.

Saving selections and using masks

About masks and alpha channels

When you select part of an image, the area that is not selected is “masked”, or protected from editing. So, when you create a mask, you isolate and protect areas of an image as you apply color changes, filters, or other effects to the rest of the image. You can also use masks for complex image editing such as gradually applying color or filter effects to an image.

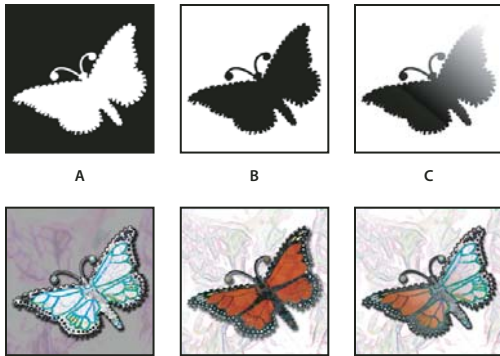

Examples of masks

A. Opaque mask used to protect the background and edit the butterfly B. Opaque mask used to protect the butterfly and color the background C. Semitransparent mask used to color the background and part of the butterfly

Masks are stored in alpha channels. Masks and channels are grayscale images, so you can edit them like any other image with painting tools, editing tools and filters. Areas painted black on a mask are protected, and areas painted white are editable.

Use Quick Mask mode to convert a selection to a temporary mask for easier editing. The Quick Mask appears as a colored overlay with adjustable opacity. You can edit the Quick Mask using any painting tool or modify it with a filter. Once you exit Quick Mask mode the mask is converted back to a selection on the image.

To save a selection more permanently, you can store it as an alpha channel. The alpha channel stores the selection as an editable grayscale mask in the Channels panel. Once stored as an alpha channel, you can reload the selection at any time or even load it into another image.



Selection saved as an alpha channel in Channels panel

Note: You can mask or hide parts of a layer using a layer mask.

See also

“[About layer and vector masks](#)” on page 319

Create a temporary quick mask

To use Quick Mask mode, start with a selection and then add to or subtract from it to make the mask. You can also create the mask entirely in Quick Mask mode. Color differentiates the protected and unprotected areas. When you leave Quick Mask mode, the unprotected areas become a selection.

Note: A temporary Quick Mask channel appears in the Channels panel while you work in Quick Mask mode. However, you do all mask editing in the image window.

- 1 Using any selection tool, select the part of the image you want to change.
- 2 Click the Quick Mask mode button  in the toolbox.

A color overlay (similar to a rubylith) covers and protects the area outside the selection. Selected areas are left unprotected by this mask. By default, Quick Mask mode colors the protected area using a red, 50% opaque overlay.

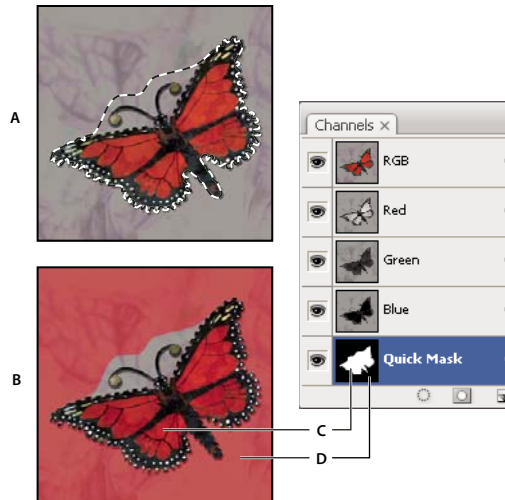

Selecting in Standard mode and Quick Mask mode
A. Standard mode **B.** Quick Mask mode **C.** Selected pixels appear as white in channel thumbnail **D.** Rubylith overlay protects area outside selection, and unselected pixels appear as black in channel thumbnail

- 3 To edit the mask, select a painting tool from the toolbox. The swatches in the toolbox automatically become black and white.
- 4 Paint with white to select more of an image (the color overlay is removed from areas painted with white). To deselect areas, paint over them with black (the color overlay covers areas painted with black). Painting with gray or another color creates a semitransparent area, useful for feathering or anti-aliased effects. (Semitransparent areas may not appear to be selected when you exit Quick Mask Mode, but they are.)

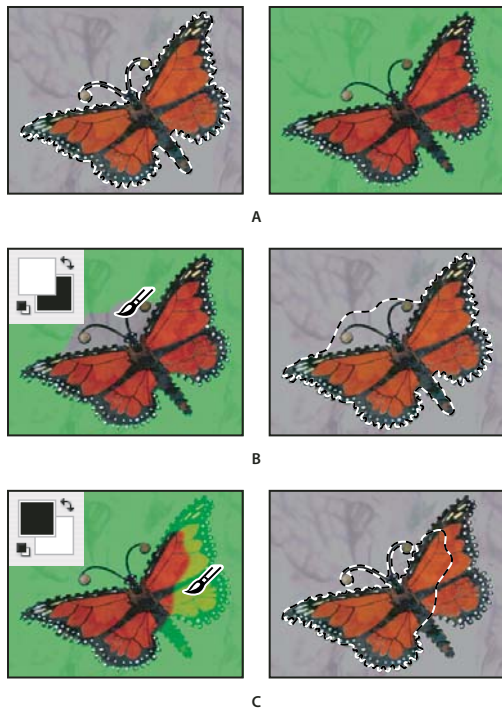

Painting in Quick Mask mode

A. Original selection and Quick Mask mode with green chosen as mask color B. Painting with white in Quick Mask mode adds to the selection C. Painting with black in Quick Mask mode subtracts from the selection

- 5 Click the Standard Mode button  in the toolbox to turn off the quick mask and return to your original image. A selection border now surrounds the unprotected area of the quick mask.

If a feathered mask is converted to a selection, the boundary line runs halfway between the black pixels and the white pixels of the mask gradient. The selection boundary indicates the transition between pixels that are less than 50% selected and those that are more than 50% selected.

- 6 Apply the desired changes to the image. Changes affect only the selected area.
- 7 Choose Select > Deselect to deselect the selection, or save the selection by choosing Select > Save Selection.

 You can convert this temporary mask to a permanent alpha channel by switching to standard mode and choosing Select > Save Selection.

Change Quick Mask options

- 1 Double-click the Quick Mask Mode button  in the toolbox.
- 2 Choose from the following display options:

Masked Areas Sets masked areas to black (opaque) and selected areas to white (transparent). Painting with black increases the masked area; painting with white increases the selected area. When this option is selected, the Quick Mask button in the toolbox becomes a white circle on a gray background .

Selected Areas Sets masked areas to white (transparent) and selected areas to black (opaque). Painting with white increases the masked area; painting with black increases the selected area. When this option is selected, the Quick Mask button in the toolbox becomes a gray circle on a white background .

 To toggle between the Masked Areas and Selected Areas options for quick masks, Alt-click (Windows) or Option-click (Mac OS) the Quick Mask Mode button.

- 3 To choose a new mask color, click the color box, and choose a new color.
- 4 To change the opacity, enter a value between 0% and 100%.

Both the color and opacity settings affect only the appearance of the mask and have no effect on how underlying areas are protected. Changing these settings may make the mask more easily visible against the colors in the image.

See also

“[Choose a color with the Adobe Color Picker](#)” on page 117

Create and edit alpha channel masks

You can create a new alpha channel and then use painting tools, editing tools, and filters to create a mask from the alpha channel. You can also save an existing selection in a Photoshop image as an alpha channel that appears in the Channels panel. See “[Save and load selections](#)” on page 274.

See also

“[About channels](#)” on page 265

Create an alpha channel mask using current options

- 1 Click the New Channel button  at the bottom of the Channels panel.
- 2 Paint on the new channel to mask out image areas.

 *Select areas of the image before you create the channel for the mask. Then paint on the channel to refine the mask.*

Create an alpha channel mask and set options

- 1 Alt-click (Windows) or Option-click (Mac OS) the New Channel button at the bottom of the Channels panel, or choose New Channel from the Channels panel menu.
- 2 Specify options in the New Channel dialog box.
- 3 Paint on the new channel to mask out image areas.

Channel options

To change options for an existing channel, double-click the channel thumbnail in the Channels panel or select Channel options from the Channels panel menu.

Options available in the New Channel and Channel Options dialog boxes:

Masked areas Sets masked areas to black (opaque) and selected areas to white (transparent). Painting with black increases the masked area; painting with white increases the selected area. When this option is selected, the Quick Mask button in the toolbox becomes a white circle on a gray background .

Selected Areas Sets masked areas to white (transparent) and selected areas to black (opaque). Painting with white increases the masked area; painting with black increases the selected area. When this option is selected, the Quick Mask button in the toolbox becomes a gray circle on a white background .

Spot Color Converts an alpha channel to a spot color channel. Only available for existing channels.

Color Sets the color and opacity of the mask. Click the color field to change the color. The color and opacity settings affect only the appearance of the mask and have no effect on how underlying areas are protected. Changing these settings may make the mask more easily visible against the colors in the image.

Paint on a channel to mask image areas

When the new channel appears at the bottom of the Channels panel, it is the only channel visible in the image window. Click the eye icon  for the composite color channel (RGB, CMYK) to display the image with a color overlay showing the mask.

- ❖ Select the brush or an editing tool and do one of the following to add or subtract from the mask created from the alpha channel:
 - To remove areas in the new channel, paint with white.
 - To add areas in the new channel, paint with black.
 - To add or remove areas using opacities less than 100%, set the Opacity in the options bar of the painting or editing tool and then paint with white or black. You can also paint with a color to achieve lower opacities.

Save and load selections

You can save any selection as a mask in a new or existing alpha channel and later reload the selection from the mask.

You can use a selection as a layer mask by loading the selection to make it active, then adding a new layer mask.

See also

[“Add layer masks”](#) on page 320

Save a selection to a new channel

- 1 Select the area or areas of the image you want to isolate.
- 2 Click the Save Selection button  at the bottom of the Channels panel. A new channel appears, named according to the sequence in which it was created.

Save a selection to a new or existing channel

- 1 Use a selection tool to select the area or areas of the image you want to isolate.
- 2 Choose Select > Save Selection.
- 3 Specify the following in the Save Selection dialog box, and click OK:

Document Chooses a destination image for the selection. By default, the selection is placed in a channel in your active image. You can choose to save the selection to a channel in another open image with the same pixel dimensions or to a new image.

Channel Chooses a destination channel for the selection. By default, the selection is saved in a new channel. You can choose to save the selection to any existing channel in the selected image or to a layer mask if the image contains layers.

- 4 If you're saving the selection as a new channel, type a name for the channel in the Name text box.
- 5 If you're saving the selection to an existing channel, select how to combine the selections:

Replace Channel Replaces the current selection in the channel.

Add to Channel Adds the selection to the current channel contents.

Subtract From Channel Deletes the selection from the channel contents.

Intersect With Channel Keeps the areas of the new selection that intersect with the channel contents.

You can select the channel from the Channels panel to see the saved selection displayed in grayscale.

Load a saved selection from the Channels panel

You can reuse a previously saved selection by loading it into an image. You can also load the selection into an image after you finish modifying an alpha channel.

❖ Do one of the following in the Channels panel:

- Select the alpha channel, click the Load Selection button  at the bottom of the panel, and then click the composite color channel near the top of the panel.
- Drag the channel containing the selection you want to load onto the Load Selection button.
- Ctrl-click (Windows) or Command-click (Mac OS) the channel containing the selection you want to load.
- To add the mask to an existing selection, press Ctrl+Shift (Windows) or Command+Shift (Mac OS), and click the channel.
- To subtract the mask from an existing selection, press Ctrl+Alt (Windows) or Command+Option (Mac OS), and click the channel.
- To load the intersection of the saved selection and an existing selection, press Ctrl+Alt+Shift (Windows) or Command+Option+Shift (Mac OS), and select the channel.

 You can drag a selection from one open Photoshop image into another.

Load a saved selection

Note: If you are loading a saved selection from another image, make sure to open it. Also, make sure your destination image is active.

1 Choose Select > Load Selection.

2 Specify the Source options in the Load Selection dialog box:

Document Chooses the source to load.

Channel Chooses the channel containing the selection you want to load.

Invert Selects the non-selected areas.

3 Select an Operation option to specify how to combine the selections if the image already has a selection:

New Selection Adds the loaded selection.

Add To Selection Adds the loaded selection to any existing selections in the image.

Subtract From Selection Subtracts the loaded selection from existing selections in the image.

Intersect With Selection Saves a selection from an area intersected by the loaded selection and existing selections in the image.

 You can drag a selection from one open Photoshop image into another.

Channel calculations

Blending layers and channels

You can use the blending effects associated with layers to combine channels within and between images into new images. You can use either the Apply Image command (on single and composite channels) or the Calculations command (on single channels). These commands offer two additional blending modes not available in the Layers panel—Add and Subtract. Although it's possible to create new combinations of channels by copying channels to layers in the Layers panel, you may find it quicker to use the calculation commands to blend channel information.

The calculation commands perform mathematical operations on the corresponding pixels of two channels (the pixels with identical locations in the image) and then combine the results in a single channel. Two concepts are fundamental to understanding how the calculation commands work.

- Each pixel in a channel has a brightness value. The Calculations and Apply Image commands manipulate these values to produce the resulting composite pixels.
- These commands overlay the pixels in two or more channels. Thus, the images used for calculations must have the same pixel dimensions.

Blend channels with the Apply Image command

The Apply Image command lets you blend one image's layer and channel (the *source*) with a layer and channel of the active image (the *destination*).

- 1 Open the source and destination images, and select the desired layer and channel in the destination image. The pixel dimensions of the images must match for image names to appear in the Apply Image dialog box.

Note: *If the color modes of the two images differ (for example, one image is RGB and the other is CMYK), you can apply a single channel (but not the source's composite) to the destination layer's composite channel.*

- 2 Choose Image > Apply Image.
- 3 Choose the source image, layer, and channel you want to combine with the destination. To use all layers in the source image, select Merged For Layer.
- 4 To preview the results in the image window, select Preview.
- 5 To use the negative of the channel contents in the calculation, select Invert.
- 6 For Blending, choose a blending option.

For information on the Add and Subtract options, see “[Add and Subtract blending modes](#)” on page 277. For information on other blending options, see “[List of blending modes](#)” on page 347.

- 7 Enter an Opacity value to specify the effect's strength.
- 8 To apply the results only to opaque areas in the result layer, select Preserve Transparency.
- 9 If you want to apply the blending through a mask, select Mask. Then choose the image and layer containing the mask. For Channel, you can choose any color or alpha channel to use as the mask. You can also use a mask based on the active selection or the boundaries of the chosen layer (Transparency). Select Invert to reverse the masked and unmasked areas of the channel.

Blend channels with the Calculations command

The Calculations command lets you blend two individual channels from one or more source images. You can then apply the results to a new image or to a new channel or selection in the active image. You cannot apply the Calculations command to composite channels.

1 Open the source image or images.

Note: If you are using more than one source image, the images must have the same pixel dimensions.

2 Choose Image > Calculations.

3 To preview the results in the image window, select Preview.

4 Choose the first source image, layer, and channel. To use all the layers in the source image, choose Merged For Layer.

5 To use the negative of the channel contents in the calculation, select Invert. For Channel, choose Gray if you want to duplicate the effect of converting the image to grayscale.

6 Choose the second source image, layer, and channel, and specify options.

7 For Blending, choose a blending mode.

For information on the Add and Subtract options, see “[Add and Subtract blending modes](#)” on page 277. For information on other blending options, see “[List of blending modes](#)” on page 347.

8 Enter an Opacity value to specify the effect’s strength.

9 If you want to apply the blending through a mask, select Mask. Then choose the image and layer containing the mask. For Channel, you can choose any color or alpha channel to use as the mask. You can also use a mask based on the active selection or the boundaries of the chosen layer (Transparency). Select Invert to reverse the masked and unmasked areas of the channel.

10 For Result, specify whether to place the blending results in a new document or in a new channel or selection in the active image.

Add and Subtract blending modes

The Add blending mode is available only for the Calculations command. The Subtract blending mode is available only for the Apply Image and Calculations command.

Add

Adds the pixel values in two channels. This is a good way to combine non-overlapping images in two channels.

Because higher pixel values represent lighter colors, adding channels with overlapping pixels lightens the image. Black areas in both channels remain black ($0 + 0 = 0$). White in either channel results in white ($255 + \text{any value} = 255$ or greater).

Add mode divides the sum of the pixel values by the Scale amount, and then adds the Offset value to the sum. For example, to find the average of the pixels in two channels, add them, divide by 2, and enter no Offset value.

The Scale factor may be any number between 1.000 and 2.000. Entering a higher Scale value darkens the image.

The Offset value lets you lighten or darken the pixels in the destination channel by any brightness value between +255 and -255. Negative values darken the image; positive values lighten the image.

Subtract

Subtracts the pixel values in the source channel from the corresponding pixels in the target channel. As with Add mode, the result is then divided by the Scale factor and added to the Offset value.

The Scale factor may be any number between 1.000 and 2.000. The Offset value lets you lighten or darken the pixels in the destination channel by any brightness value between +255 and -255.

Chapter 10: Layers

Layers are the building blocks of many image creation workflows. You may not need to work with layers if you are doing simple image adjustments, but layers help you work efficiently and are essential to most nondestructive image editing.

Layer Basics

About layers

Photoshop layers are like sheets of stacked acetate. You can see through transparent areas of a layer to the layers below. You move a layer to position the content on the layer, like sliding a sheet of acetate in a stack. You can also change the opacity of a layer to make content partially transparent.

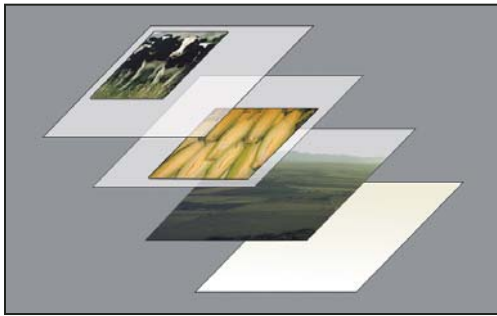

Transparent areas on a layer let you see layers below.

You use layers to perform tasks such as compositing multiple images, adding text to an image, or adding vector graphic shapes. You can apply a layer style to add a special effect such as a drop shadow or a glow.

Work non-destructively

Sometimes layers don't contain any apparent content. For example, an *adjustment* layer holds color or tonal adjustments that affect the layers below it. Rather than edit image pixels directly, you can edit an adjustment layer and leave the underlying pixels unchanged.

A special type of layer, called a *Smart Object*, contains one or more layers of content. You can transform (scale, skew, or reshape) a Smart Object without directly editing image pixels. Or, you can edit the Smart Object as a separate image even after placing it in a Photoshop image. Smart Objects can also contain smart filter effects, which allow you to apply filters non-destructively to images so that you can later tweak or remove the filter effect. See “[Nondestructive editing](#)” on page 309.

Organize layers

A new image has a single layer. The number of additional layers, layer effects, and layer sets you can add to an image is limited only by your computer's memory.

You work with layers in the Layers panel. *Layer groups* help you organize and manage layers. You can use groups to arrange your layers in a logical order and to reduce clutter in the Layers panel. You can nest groups within other groups. You can also use groups to apply attributes and masks to multiple layers simultaneously.

Video layers

You can use video layers to add video to an image. After importing a video clip into an image as a video layer, you can mask the layer, transform it, apply layer effects, paint on individual frames, or rasterize an individual frame and convert it to a standard layer. Use the Timeline panel to play the video within the image or to access individual frames. See “Supported video and image sequence formats (Photoshop Extended)” on page 528.

For a video on using layers, see www.adobe.com/go/vid0001.

See also

[Using layers video](#)

Layers panel overview

The Layers panel lists all layers, layer groups, and layer effects in an image. You can use the Layers panel to show and hide layers, create new layers, and work with groups of layers. You can access additional commands and options in the Layers panel menu.

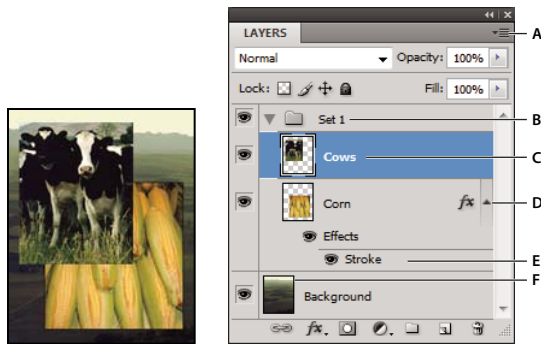

Photoshop Layers panel

A. Layers panel menu B. Layer Group C. Layer D. Expand/Collapse Layer effects E. Layer effect F. Layer thumbnail

Display the Layers panel

- ❖ Choose Window > Layers.

Choose a command from the Layers panel menu

- ❖ Click the triangle in the upper right corner of the panel.

Change the size of layer thumbnails

- ❖ Choose panel Options from the Layers panel menu, and select a thumbnail size.

Change thumbnail contents

- ❖ Choose panel Options from the Layers panel menu, and select Entire Document to display the contents of the entire document. Select Layer Bounds to restrict the thumbnail to the object’s pixels on the layer.



Turn off thumbnails to improve performance and save monitor space.

Expand and collapse groups

- ❖ Click the triangle to the left of a group folder. See “View layers and groups within a group” on page 283.

Convert background and layers

When you create a new image with a white background or a colored background, the bottommost image in the Layers panel is called *Background*. An image can have only one background layer. You cannot change the stacking order of a background layer, its blending mode, or its opacity. However, you can convert a background into a regular layer, and then change any of these attributes.

When you create a new image with transparent content, the image does not have a background layer. The bottommost layer is not constrained like the background layer; you can move it anywhere in the Layers panel and change its opacity and blending mode.

Convert a background into a layer

- 1 Double-click Background in the Layers panel, or choose Layer > New > Layer From Background.
- 2 Set layer options. (See “[Create layers and groups](#)” on page 281.)
- 3 Click OK.

Convert a layer into a background

- 1 Select a layer in the Layers panel.
- 2 Choose Layer > New > Background From Layer.



Any transparent pixels in the layer are converted to the background color, and the layer drops to the bottom of the layer stack.

Note: You cannot create a background by giving a regular layer the name, *Background*—you must use the *Background From Layer* command.

Create layers and groups

A new layer appears either above the selected layer or within the selected group in the Layers panel.

Create a new layer or group

- 1 Do one of the following:
 - To create a new layer or group using default options, click the Create a New Layer button  or New Group button  in the Layers panel.
 - Choose Layer > New > Layer or choose Layer > New > Group.
 - Choose New Layer or New Group from the Layers panel menu.
 - Alt-click (Windows) or Option-click (Mac OS) the Create a New Layer button or New Group button in the Layers panel to display the New Layer dialog box and set layer options.
 - Ctrl-click (Windows) or Command-click (Mac OS) the Create a New Layer button or New Group button in the Layers panel to add a layer below the currently selected layer.
- 2 Set layer options, and click OK:

Name Specifies a name for the layer or group.

Use Previous Layer to Create Clipping Mask This option is not available for groups. (See “[Mask layers with clipping masks](#)” on page 326.)

Color Assigns a color to the layer or group in the Layers panel.

Mode Specifies a blending mode for the layer or group. (See “[About blending modes](#)” on page 346.)

Opacity Specifies an opacity level for the layer or group.

Fill With Mode-Neutral Color Fills the layer with a preset, neutral color.

Note: To add currently selected layers to a new group, choose Layer > Group Layers, or Shift-click the New Group button at the bottom of the Layers Panel.

Create a new layer with effects from another layer

- 1 Select the existing layer in the Layers panel.
- 2 Drag the layer to the Create a New Layer button at the bottom of the Layers panel. The newly created layer contains all the effects of the existing one.

Convert a selection into a new layer

- 1 Make a selection.
- 2 Do one of the following:
 - Choose Layer > New > Layer Via Copy to copy the selection into a new layer.
 - Choose Layer > New > Layer Via Cut to cut the selection and paste it into a new layer.

Note: You must rasterize Smart Objects or shape layers to enable these commands.

Duplicate layers

You can duplicate layers within an image or into another or a new image.

Duplicate a layer or group within an image

- 1 Select a layer or group in the Layers panel.
- 2 Do one of the following:
 - Drag the layer or group to the Create a New Layer button .
 - Choose Duplicate Layer or Duplicate Group from the Layers menu or the Layers panel menu. Enter a name for the layer or group, and click OK.



Duplicate a layer or group between images

- 1 Open the source and destination images.
- 2 From the Layers panel of the source image, select one or more layers or a layer group.
- 3 Do one of the following:
 - Drag the layer or group from the Layers panel to the destination image.
 - Select the Move tool , and drag from the source image to the destination image. The duplicate layer or group appears above the active layer in the Layers panel of the destination image. Shift-drag to move the image content to the same location it occupied in the source image (if the source and destination images have the same pixel dimensions) or to the center of the document window (if the source and destination images have different pixel dimensions).
 - Choose Duplicate Layer or Duplicate Group from the Layers menu or the Layers panel menu. Choose the destination document from the Document pop-up menu, and click OK.
 - Choose Select > All to select all the pixels on the layer, and choose Edit > Copy. Then choose Edit > Paste in the destination image.

Create a new document from a layer or group

- 1 Select a layer or group from the Layers panel.
- 2 Choose Duplicate Layer or Duplicate Group from the Layers menu or the Layers panel menu.
- 3 Choose New from the Document pop-up menu, and click OK.

Show or hide a layer, group, or style

- ❖ Do one of the following in the Layers panel:
 - Click the eye icon  next to a layer, group, or layer effect to hide its content in the document window. Click in the column again to redisplay the content. To view the eye icon for styles and effects, click the Reveal Effects In panel icon .
 - Choose Show Layers or Hide Layers from the Layers menu.
 - Alt-click (Windows) or Option-click (Mac OS) an eye icon  to display only the contents of that layer or group. Photoshop remembers the visibility states of all layers before hiding them. If you don't change the visibility of any other layer, Alt-clicking (Windows) or Option-clicking (Mac OS) the same eye icon restores the original visibility settings.
 - Drag through the eye column to change the visibility of multiple items in the Layers panel.

Note: Only visible layers are printed.

View layers and groups within a group

- ❖ Do one of the following to open the group:
 - Click the triangle to the left of the folder icon .
 - Right-click (Windows) or Control-click (Mac OS) the triangle to the left of the folder icon and choose Open This Group.
 - Alt-click (Windows) or Option-click (Mac OS) the triangle to open or close a group and the groups nested within it.

Sample from all visible layers

The default behavior of the Magic Wand, Smudge, Blur, Sharpen, Paint Bucket, Clone Stamp, and Healing Brush tools is to sample color only from pixels on the active layer. This means you can smudge or sample in a single layer.

- ❖ To smudge or sample pixels from all visible layers with these tools, select Sample All Layers from the options bar.

Change transparency preferences

- 1 In Windows, choose Edit > Preferences > Transparency & Gamut; in Mac OS, choose Photoshop > Preferences > Transparency & Gamut.
- 2 Choose a size and color for the transparency checkerboard, or choose None for Grid Size to hide the transparency checkerboard.
- 3 Click OK.

Selecting, grouping, and linking layers

Select layers

You can select one or more layers to work on them. For some activities, such as painting or making color and tonal adjustments, you can work on only one layer at a time. A single selected layer is called the *active layer*. The name of the active layer appears in the title bar of the document window.

For other activities, such as moving, aligning, transforming, or applying styles from the Styles panel, you can select and work on multiple layers at a time. You can select layers in the Layers panel or with the Move tool .

You can also link layers. Unlike multiple layers selected at the same time, linked layers stay linked when you change the selection in the Layers panel. See “[Link and unlink layers](#)” on page 285.

 *If you don't see the desired results when using a tool or applying a command, you may not have the correct layer selected. Check the Layers panel to make sure that you're working on the correct layer.*

Select layers in the Layers panel

❖ Do one of the following:

- Click a layer in the Layers panel.
- To select multiple contiguous layers, click the first layer and then Shift-click the last layer.
- To select multiple noncontiguous layers, Ctrl-click (Windows) or Command-click (Mac OS) them in the Layers panel.

Note: When selecting, Ctrl-click (Windows) or Command-click (Mac OS) the area outside the layer thumbnail. Ctrl-clicking or Command-clicking the layer thumbnail selects the nontransparent areas of the layer.

- To select all layers, choose Select > All Layers.
- To select all layers of a similar type (for example all type layers), select one of the layers and choose Select > Select Similar Layers.
- To deselect a layer, Ctrl-click the layer.
- To have no layer selected, click in the Layers panel below the background or bottom layer, or choose Select > Deselect Layers.

Select layers in the document window

1 Select the Move tool .

2 Do one of the following:

- In the options bar, select Auto Select, then choose Layer from the drop-down menu, and click in the document on the layer you want to select. The top layer containing pixels under the cursor is selected.
- In the options bar, select Auto Select, then choose Group from the drop-down menu, and click in the document on the content you want to select. The top group containing pixels under the cursor is selected. If you click an ungrouped layer, it becomes selected.
- Right-click (Windows) or Control-click (Mac OS) in the image, and choose a layer from the context menu. The context menu lists all the layers that contain pixels under the current pointer location.

Select a layer in a group



1 Click the group in the Layers panel.

- 2 Click the triangle to the left of the folder icon .
- 3 Click the individual layer in the group.

Group and ungroup layers

- 1 Select multiple layers in the Layers panel.
- 2 Do one of the following:
 - Choose Layer > Group Layers.
 - Alt-drag (Windows) or Option-drag (Mac OS) layers to the folder icon  at the bottom of the Layers panel to group the layers.
- 3 To Ungroup the layers, select the group and choose Layer > Ungroup Layers.

Add layers to a group

- ❖ Do one of the following:
 - Select the group in the Layers panel and click the Create a New Layer button .
 - Drag a layer to the group folder.
 - Drag a group folder into another group folder. The group and all of its layers move.
 - Drag an existing group to the New Group button .

Link and unlink layers

You can link two or more layers or groups. Unlike multiple layers selected at the same time, linked layers retain their relationship until you unlink them. You can move or apply transformations to linked layers.

- 1 Select the layers or groups in the Layers panel.
- 2 Click the link icon  at the bottom of the Layers panel.
- 3 To unlink layers do one of the following:
 - Select a linked layer, and click the link icon.
 - To temporarily disable the linked layer, Shift-click the Link icon for the linked layer. A red X appears. Shift-click the link icon to enable the link again.
 - Select the linked layers and click the Link icon. To select all linked layers, select one of the layers and then choose Layer > Select Linked Layers.

Moving, stacking, and locking layers

Change the stack order of layers and groups

- ❖ Do one of the following:
 - Drag the layer or group up or down in the Layers panel. Release the mouse button when the highlighted line appears where you want to place the layer or group.
 - To move a layer into a group, drag a layer to the group folder . If the group is closed, the layer is placed at the bottom of the group.

Note: If a group is expanded so that you can see all the layers within it, adding a layer beneath the expanded group automatically adds the layer to that group. To avoid this, collapse the group before adding the new layer.

- Select a layer or group, choose Layer > Arrange, and choose a command from the submenu. If the selected item is in a group, the command applies to the stacking order within the group. If the selected item is not in a group, the command applies to the stacking order within the Layers panel.
- To reverse the order of selected layers, choose Layer > Arrange > Reverse. These options appear dimmed if you do not have at least two layers selected.

Note: By definition, the background layer is always at the bottom of the stacking order. Therefore, the Send To Back command places the selected item directly above the background layer.

Show layer edges and handles

Showing the boundary or edges of the content in a layer can help you move and align the content. You can also display the transform handles for selected layers and groups so that you can resize or rotate them.



Layer content with edges showing (left) and with transform mode selected (right)

Display the edges of content in a selected layer

- ❖ Choose View > Show > Layer Edges.

Display transform handles in a selected layer

- 1 Select the Move tool .
- 2 From the options bar, select Show Transform Controls.

You can resize and rotate layer content using the transform handles. See “[Transform freely](#)” on page 217.

Move the content of layers

- 1 From the Layers panel, select the layers containing the objects you want to move.
- 2 Select the Move tool .

 You can select the layers that you want to move directly in the document window. In the Move tool’s options bar, select Auto Select, then choose Layer from the drop-down menu. Shift-click to select multiple layers. Select Auto Select, then choose Group, to select the entire group when you select one layer in the group.

- 3 Do one of the following:
 - In the document window, drag any object onto one of the selected layers. (All objects on the layer will move together.)
 - Press an arrow key on the keyboard to nudge the objects by 1 pixel.
 - Hold down Shift and press an arrow key on the keyboard to nudge the objects by 10 pixels.

Align objects on different layers

You can align the content of layers and groups using the Move tool . (See “Move the content of layers” on page 286.)

1 Do one of the following:

- To align multiple layers, select the layers with the Move tool or in the Layers panel, or select a group.
- To align the content of one or more layers to a selection border, make a selection in the image, and then select the layers in the Layers panel. Use this method to align to any specified point in the image.

2 Choose Layer > Align or Layer > Align Layers To Selection, and choose a command from the submenu. These same commands are available as Alignment buttons in the Move tool options bar.

Top Edges  Aligns the top pixel on the selected layers to the topmost pixel on all selected layers, or to the top edge of the selection border.

Vertical Centers  Aligns the vertical center pixel on each selected layers to the vertical center pixel of all the selected layers, or to the vertical center of the selection border.

Bottom Edges  Aligns the bottom pixel on the selected layers to the bottommost pixel on selected layers, or to the bottom edge of the selection border.

Left Edges  Aligns the left pixel on the selected layers to the left pixel on the leftmost layer, or to the left edge of the selection border.

Horizontal Centers  Aligns the horizontal center pixel on the selected layers to the horizontal center pixel of all the selected layers, or to the horizontal center of the selection border.

Right Edges  Aligns the right pixel on the linked layers to the rightmost pixel on all selected layers, or to the right edge of the selection border.

See also

“Automatically align image layers” on page 287

Distribute layers and groups evenly

1 Select three or more layers.

2 Choose Layer > Distribute and choose a command. Alternatively, select the Move tool  and click a distribution button in the options bar.

Top Edges  Spaces the layers evenly, starting from the top pixel of each layer.

Vertical Centers  Spaces the layers evenly, starting from the vertical center pixel of each layer.

Bottom Edges  Spaces the layers evenly, starting from the bottom pixel of each layer.

Left Edges  Spaces the layers evenly, starting from the left pixel of each layer.

Horizontal Centers  Spaces the layers evenly, starting from the horizontal center of each layer.

Right Edges  Spaces the layers evenly, starting from the right pixel on each layer.

Automatically align image layers

The Auto-Align Layers command can automatically align layers based on similar content in different layers, such as corners and edges. You assign one layer as a reference layer, or let Photoshop automatically choose the reference layer. Other layers are aligned to the reference layer so that matching content overlays itself.

Using the Auto-Align Layers command, you can combine images in several ways:

- Replace or delete parts of images that have the same background. After aligning the images, use masking or blending effects to combine parts of each image into one image.
- Stitch images together that share overlapping content.
- For video frames shot against a static background, you can convert frames into layers, then add or delete content across multiple frames.

1 Copy or place the images you want to align into the same document.

Each image will be in a separate layer. See “[Duplicate layers](#)” on page 282.

 You can load multiple images into layers using a script. Choose File > Scripts > Load Files into Stack.

2 (Optional) In the Layers panel, create a reference layer by locking it. See “[Lock layers](#)” on page 290. If you do not set a reference layer, Photoshop will analyze all the layers and select the one at the center of the final composition as the reference.

3 Select the remaining layers you want to align.

To select multiple adjacent layers from the panel, Shift-click; To select noncontiguous layers, Ctrl-Click (Windows) or Command-click (Mac OS).

Note: Do not select adjustment layers, vector layers, or Smart Objects which do not contain information needed for alignment.

4 Choose Edit > Auto-Align Layers, and choose an alignment option. For stitching together multiple images that share overlapping areas—for example, to create a panorama—use the Auto, Perspective, or Cylindrical options. To align scanned images with offset content, use the Reposition Only option.

Auto Photoshop analyzes the source images and applies either a Perspective or Cylindrical layout, depending on which produces a better composite.

Perspective Creates a consistent composition by designating one of the source images (by default, the middle image) as the reference image. The other images are then transformed (repositioned, stretched, or skewed, as necessary) so that overlapping content across layers is matched.

Cylindrical Reduces the “bow-tie” distortion that can occur with the Perspective layout by displaying individual images as on an unfolded cylinder. Overlapping content across layers is still matched. The reference image is placed at the center. Best suited for creating wide panoramas.

Spherical Aligns images with wide fields of view (vertical and horizontal). Designates one of the sources images (the middle image, by default) as the reference image and spherically transforms the other images so that overlapping content is matched.

Scene Collage Aligns layers and matches overlapping content, without changing the shape of the objects in the image (for example, a circle will still be a circle).

Reposition Only Aligns the layers and matches overlapping content, but does not transform (stretch or skew) any of the source layers.

Lens Correction Automatically corrects for lens defects:

- **Vignette Removal** Compensates for a lens defect that causes the edges, especially the corners, of an image to be darker than the center.
- **Geometric Distortion** Compensates for barrel, pincushion, or fisheye distortion.

Note: *Geometric Distortion* will try to take into account the radical distortion to improve the result of the alignment, except with fish eye lens; when fish eye metadata is detected, *Geometric Distortion* will align the images for fish eye

After auto-aligning, you can use Edit > Free Transform to fine tune the alignment or make tonal adjustments to even out exposure differences between layers, then combine the layers into one composite image.

For a video on aligning layers by content, see www.adobe.com/go/vid0014.

For a video on using Auto-Align and Auto-Blend to create a panorama and increase depth of field, and using content-aware scaling, see www.adobe.com/go/lrvid4120_ps.

See also

“Create panoramic images” on page 243

“Combine multiple images into a group portrait” on page 327

“Image Stacks (Photoshop Extended)” on page 611

[Aligning layers by content video](#)

Auto blend layers

Use the Auto-Blend Layers command to stitch or combine images with smooth transitions in the final composite image. Auto-Blend Layers applies layer masks as needed to each layer to mask out over- or underexposed areas or content differences. Auto-Blend layers is only available for RGB or Grayscale images. It does not work with Smart Objects, video layers, 3D layers, or background layers.

Among the many uses of the Auto-Blend Layers command, you can blend multiple images of a scene with different areas in focus to achieve a composite image with an extended depth of field. Similarly, you can create a composite by blending multiple images of a scene with different illuminations. In addition to combining images of a scene, you can stitch together images into a panorama. (Although, it might be better to use the Photomerge command to produce panoramas from multiple images.)

Auto-Blend Layers applies layer masks as needed to each layer to mask out over- or underexposed areas or content differences and create a seamless composite.

1 Copy or place the images you want to combine into the same document.

Each image will be in a separate layer. See “[Duplicate layers](#)” on page 282.

2 Select the layers you want to blend.

3 (Optional) Align the layers.

You can align layers manually or by using the Auto-Align Layers command. See “[Automatically align image layers](#)” on page 287.

4 With the layers still selected, choose Edit > Auto-Blend Layers.

5 Select the Auto-Blend Objective:

Panorama Blends overlapping layers into a panorama image.

Stack Images Blends the best details in each corresponding area. This options works best with aligned layers.

Note: *Stack Images* lets you blend multiple images of a scene with different areas in focus or different illuminations, to achieve the best results of all the images (you must auto-align the images first).

6 Select Seamless Tones And Colors to adjust the color and tonality for blending.

7 Click OK.

For a video on using Auto-Align and Auto-Blend to create a panorama and increase depth of field, and using content-aware scaling, see www.adobe.com/go/lrvid4120_ps.

See also

“[Combine multiple images into a group portrait](#)” on page 327

“[Create panoramic images](#)” on page 243

Rotate a layer

- 1 From the Layers panel, select the layer you want to rotate.
- 2 If anything is currently selected in the image, choose Select > Deselect.
- 3 Choose Edit > Transform > Rotate. A box defining the boundaries of the layer (called a bounding box) appears.
- 4 Move the pointer outside of the bounding box (the pointer becomes a curved, two-sided arrow), and then drag. Press Shift to constrain the rotation to 15° increments.
- 5 When you're satisfied with the results, press Enter (Windows) or Return (Mac OS), or click the check mark in the options bar. To cancel the rotation, press Esc, or click the Cancel Transform icon on the options bar.

See also

“[Rotate or flip an entire image](#)” on page 195

“[Scale, rotate, skew, distort, apply perspective, or warp](#)” on page 216

Lock layers

You can lock layers fully or partially to protect their contents. For instance, you may want to lock a layer fully when you finish with it. You may want to lock a layer partially if it has the correct transparency and styles, but you are still deciding on positioning. When a layer is locked, a lock icon  appears to the right of the layer name. The lock icon is solid when the layer is fully locked and hollow when the layer is partially locked.

Lock all properties of a layer or group

- 1 Select a layer or group.
- 2 Click the Lock All  option in the Layers panel.

Note: Layers in a locked group display a dimmed lock icon .

Partially lock a layer

- 1 Select a layer.
- 2 Click one or more lock options in the Layers panel.

Lock Transparent Pixels  Confines editing to the opaque portions of the layer. This option is equivalent to the Preserve Transparency option in earlier versions of Photoshop.

Lock Image Pixels  Prevents modification of the layer's pixels using the painting tools.

Lock Position  Prevents the layer's pixels from being moved.

Note: For type and shape layers, Lock Transparency and Lock Image are selected by default and cannot be deselected.

Apply lock options to selected layers or a group

- 1 Select multiple layers or a group.
- 2 Choose Lock Layers or Lock All Layers In Group from the Layers menu or the Layers panel menu.
- 3 Select lock options, and click OK.

Managing layers

Rename a layer or group

As you add layers to an image, it's helpful to give them names that reflect their content. Descriptive names make layers easy to identify in the panel.

- ❖ Do one of the following:
 - Double-click the layer name or group name in the Layers panel, and enter a new name.
 - Press Alt (Windows) or Option (Mac OS), and double-click the layer (not its name or thumbnail) in the Layers panel. Enter a new name in the Name text box, and click OK.
 - Select a layer or group, and choose Layer Properties or Group Properties from the Layers menu or the Layers panel menu. Enter a new name in the Name text box, and click OK.

Assign a color to a layer or group

Color coding layers and groups helps you locate related layers in the Layers panel.

- 1 Do one of the following:
 - Select a layer or group, and choose Layer Properties or Group Properties from the Layers menu or the Layers panel menu.
 - Press Alt (Windows) or Option (Mac OS), and double-click the layer (not its name or thumbnail) in the Layers panel.
- 2 Choose a color from the Color pop-up menu, and click OK.

Rasterize layers

You cannot use the painting tools or filters on layers that contain vector data (such as type layers, shape layers, vector masks, or Smart Objects) and generated data (such as fill layers). However, you can rasterize these layers to convert their contents into a flat, raster image.

- ❖ Select the layers you want to rasterize, choose Layer > Rasterize, and then choose an option from the submenu:

Type Rasterizes the type on a type layer. It does not rasterize any other vector data on the layer.

Shape Rasterizes a shape layer.

Fill Content Rasterizes the fill of a shape layer, leaving the vector mask.

Vector Mask Rasterizes the vector mask on a layer, turning it into a layer mask.

Smart Object Converts a Smart Object into a raster layer.

Video Rasterizes the current video frame to an image layer.

3D (Extended only) Rasterizes the current view of 3D data into a flat raster layer.



Layer Rasterizes all vector data on the selected layers.

All Layers Rasterizes all layers that contain vector and generated data.

Note: To rasterize linked layers, select a linked layer, choose **Layer > Select Linked Layers**, and then rasterize the selected layers.

Delete a layer or group

Deleting layers you no longer need reduces the size of your image file.

- 1 Select one or more layers or groups from the Layers panel.
- 2 Do one of the following:
 - To delete with a confirmation message, click the Delete icon . Alternatively, choose **Layers > Delete > Layer or Delete Layer or Delete Group** from the Layers panel menu.
 - To delete the layer or group without confirmation, drag it to the Delete icon , Alt-click (Windows) or Option-click (Mac OS) the Delete icon, or click the Delete key with the Move tool active.
 - To delete hidden layers, choose **Layers > Delete > Hidden Layers**.

 *To delete linked layers, select a linked layer, choose **Layer > Select Linked Layers**, and then delete the layers.*

Export layers

You can export all layers or visible layers to separate files.

- ❖ Choose **File > Scripts > Export Layers To Files**.

Track file size

File size depends on the pixel dimensions of an image and the number of layers it contains. Images with more pixels may produce more detail when printed, but they require more disk space to store and may be slower to edit and print. You should keep track of your file sizes to make sure the files are not becoming too large for your purposes. If the file is becoming too large, reduce the number of layers in the image or change the image size.

- ❖ You can view file size information for an image at the bottom of the application window.

See also

[“Display file information in the document window”](#) on page 34

Merge and stamp layers

When you have finalized the content of layers, you can merge them to reduce the size of your image files. When you merge layers, the data on the top layers replaces any data it overlaps on the lower layers. The intersection of all transparent areas in the merged layers remains transparent.

Note: You cannot use an adjustment layer or fill layer as the target layer for a merge.

In addition to merging layers, you can stamp them. Stamping allows you to merge the contents of more than one layer into a target layer while leaving the other layers intact.

Note: When you save a merged document, you cannot revert back to the unmerged state; the layers are permanently merged.

Merge two layers or groups

- 1 Make sure that the layers and groups you want to merge are visible.
- 2 Select the layers and groups you want to merge.
- 3 Choose Layer > Merge Layers.

Note: You can merge two adjacent layers or groups by selecting the top item and then choosing Layer > Merge Layers. You can merge linked layers by choosing Layer > Select Linked Layers, and then merging the selected layers. You can merge two 3D layers by choosing Layer > Merge Layers; they will share the same scene and the top layer will inherit the bottom layer 3D properties (the camera views must be the same for this to be enabled).

Merge layers in a clipping mask

- 1 Hide any layers that you do not want to merge.
- 2 Select the base layer in the clipping mask. The base layer must be a raster layer.
- 3 Choose Merge Clipping Mask from the Layers menu or the Layers panel menu.

For more information on clipping masks, see “[Mask layers with clipping masks](#)” on page 326.

Merge all visible layers and groups in an image

- ❖ Choose Merge Visible from the Layers panel or the Layers panel menu. All layers showing an eye icon  are merged.

Note: A visible layer must be selected to enable the Merge Visible command.

Stamp multiple layers or linked layers

When you stamp multiple selected layers or linked layers, Photoshop creates a new layer containing the merged content.

- 1 Select multiple layers.
- 2 Press Ctrl+Alt+E (Windows) or Command+Option+E (Mac OS).

Stamp all visible layers

- 1 Turn visibility on for the layers you want to merge.
- 2 Press Shift+Ctrl+Alt+E (Windows) or Shift+Command+Option+E (Mac OS).

Photoshop creates a new layer containing the merged content.

Flatten all layers

Flattening reduces file size by merging all visible layers into the background and discarding hidden layers. Any transparent areas that remain are filled with white. When you save a flattened image, you cannot revert back to the unflattened state; the layers are permanently merged.

Note: Converting an image between some color modes flattens the file. Save a copy of your file with all layers intact if you want to edit the original image after the conversion.

- 1 Make sure that all the layers you want to keep are visible.
- 2 Choose Layer > Flatten Image, or choose Flatten Image from the Layers panel menu.

Setting opacity and blending

Specify opacity for a layer or group

A layer's opacity determines to what degree it obscures or reveals the layer beneath it. A layer with 1% opacity appears nearly transparent, whereas one with 100% opacity appears completely opaque.

Note: You cannot change the opacity of a background layer or a locked layer. You can, however, convert a background layer into a regular layer, which does support transparency. See “[Convert background and layers](#)” on page 281.

- 1 Select a layer or group in the Layers panel.
- 2 Do one of the following:
 - In the Layers panel, enter a value in the Opacity text box or drag the Opacity pop-up slider.
 - Choose Layer > Layer Style > Blending Options. Enter a value in the Opacity text box or drag the Opacity pop-up slider.
 - Select the Move tool  and type a number indicating the percentage of opacity.

Note: To view blending options for a text layer, choose Layer > Layer Style > Blending Options, or choose Blending Options from the Add A Layer Style icon  at the bottom of the Layers panel menu.

Specify fill opacity for a layer

In addition to setting opacity, which affects any layer styles and blending modes applied to the layer, you can specify a fill opacity for layers. Fill opacity affects pixels painted in a layer or shapes drawn on a layer without affecting the opacity of any layer effects that have been applied to the layer.

For example, if your layer contains a drawn shape or text that uses a drop shadow layer effect, adjust the fill opacity to change the opacity of the shape or text itself without changing the opacity of the shadow.

- ❖ Do one of the following:
 - In the Layers panel, enter a value in the Fill Opacity text box or drag the Fill Opacity pop-up slider.
 - Double-click a layer thumbnail, choose Layer > Layer Style > Blending Options, and enter a value in the Fill Opacity text box or drag the Fill Opacity pop-up slider.

Note: To view blending options for a text layer, choose Layer > Layer Style > Blending Options, or choose Blending Options from the Add A Layer Style icon  at the bottom of the Layers panel. Enter a value in the Fill Opacity text box.

Specify a blending mode for a layer or group

A layer's blending mode determines how its pixels blend with underlying pixels in the image. You can create a variety of special effects using blending modes.

By default, the blending mode of a layer group is Pass Through, which means that the group has no blending properties of its own. When you choose a different blending mode for a group, you effectively change the order in which the image components are put together. All of the layers in the group are put together first. The composite group is then treated as a single image and blended with the rest of the image using the selected blending mode. Thus, if you choose a blending mode other than Pass Through for the group, none of the adjustment layers or layer blending modes inside the group will apply to layers outside the group.

Note: There is no Clear blending mode for layers. In addition, the Color Dodge, Color Burn, Darken, Lighten, Difference, and Exclusion modes are unavailable for Lab images. Layer blending modes available for 32-bit files are Normal, Dissolve, Darken, Multiply, Linear Dodge (Add), Color Darken, Lighten, Color Lighten, Difference, Hue, Saturation, Color, and Luminosity.

- 1 Select a layer or group from the Layers panel.
- 2 Choose a blending mode:
 - From the Layers panel, choose an option from the Blend Mode pop-up menu.
 - Choose Layer > Layer Style > Blending Options, and then choose an option from the Blend Mode pop-up menu.

For a video on using blending modes, see www.adobe.com/go/vid0012.

See also

“[List of blending modes](#)” on page 347

Filling new layers with a neutral color

You can't apply certain filters (such as the Lighting Effects filter) to layers with no pixels. Selecting Fill With (Mode)-Neutral Color in the New Layer dialog box resolves this problem by first filling the layer with a preset, neutral color. This invisible, neutral color is assigned according to the layer's blending mode. If no effect is applied, filling with a neutral color has no effect on the remaining layers. The Fill With Neutral Color option is not available for layers that use the Normal, Dissolve, Hard Mix, Hue, Saturation, Color, or Luminosity modes.

Create a knockout

Knockout options let you specify which layers “punch through” to reveal content from other layers. For example, you can use a text layer to knock out a color adjustment layer and reveal a portion of the image using the original colors.

As you plan your knockout effect, you need to decide which layer will create the shape of the knockout, which layers will be punched through, and which layer will be revealed. If you want to reveal a layer other than the Background, you can place the layers you want to use in a group or clipping mask.

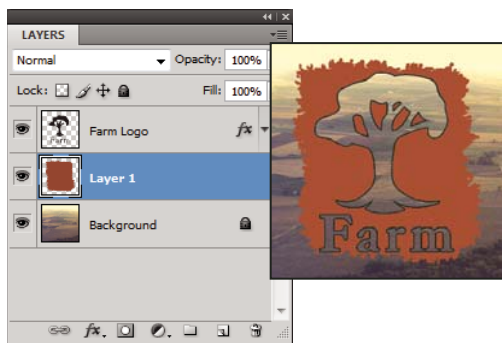

Farm logo with shallow knockout to Background layer

- 1 Do one of the following in the Layers panel:
 - To reveal the background, position the layer that will create the knockout above the layers that will be punched through, and make sure the bottom layer in the image is a Background layer. (Choose Layer > New > Background From Layer to convert a regular layer into a Background layer.)

- To reveal a layer above the background, place the layers you want to punch through in a group. The top layer in the group will punch through the grouped layers to the next layer below the group. If you want to punch all the way through to the background, set the blending mode for the group to Pass Through (the default setting).
- To reveal the base layer of a clipping mask, place the layers you want to use in a clipping mask. (See “[Mask layers with clipping masks](#)” on page 326.) Make sure that the Blend Clipped Layers As Group option is selected for the base layer. (See “[Group blend effects](#)” on page 296.)

2 Select the top layer (the layer that will create the knockout).

3 To display blending options, either double-click the layer (anywhere outside the layer name or thumbnail), choose Layer > Layer Style > Blending Options, or choose Blending Options from the Layers panel menu.

Note: To view blending options for a text layer, choose Layer > Layer Style > Blending Options, or choose Blending Options from the Add A Layer Style button at the bottom of the Layers panel menu.

4 Choose an option from the Knockout pop-up menu:

- Select Shallow to knock out to the first possible stopping point, such as the first layer after the layer group or the base layer of the clipping mask.
- Select Deep to knock out to the background. If there is no background, Deep knocks out to transparency.

Note: If you are not using a layer group or clipping mask, either Shallow or Deep creates a knockout that reveals the background layer (or transparency, if the bottom layer is not a background layer).

5 To create the knockout effect, do one of the following:

- Lower the fill opacity.
- Using the choices in the Blend Mode menu, change the blending mode to reveal the underlying pixels.

6 Click OK.

Exclude channels from blending

You can restrict blending effects to a specified channel when you blend a layer or group. By default, all channels are included. When using an RGB image, for example, you can choose to exclude the red channel from blending; in the composite image, only the information in the green and blue channels is affected.

1 Do one of the following:

- Double-click a layer thumbnail.
- Choose Layer > Layer Style > Blending Options.
- Choose Blending Options from the Add A Layer Style icon  at the bottom of the Layers panel.

Note: To view blending options for a text layer, choose Layer > Layer Style > Blending Options, or choose Blending Options from the Add A Layer Style button at the bottom of the Layers panel menu.

2 From the Advanced Blending area of the Layer Style dialog box, deselect any channels you do not want to include when the layer is blended.

Group blend effects

By default, layers in a clipping mask are blended with the underlying layers using the blending mode of the bottommost layer in the group. However, you can choose to have the blending mode of the bottommost layer apply only to that layer, allowing you to preserve the original blending appearance of the clipped layers. (See “[Mask layers with clipping masks](#)” on page 326.)

You can also apply the blending mode of a layer to layer effects that modify opaque pixels, such as Inner Glow or Color Overlay, without changing layer effects that modify only transparent pixels, such as Outer Glow or Drop Shadow.

- 1 Select the layer that you want to affect.
- 2 Double-click a layer thumbnail, choose Blending Options from the Layers panel menu, or choose Layer > Layer Style > Blending Options.

Note: To view blending options for a text layer, choose Layer > Layer Style > Blending Options, or choose Blending Options from the Add A Layer Style button at the bottom of the Layers panel menu.

- 3 Specify the scope of blending options:
 - Select Blend Interior Effects As Group to apply the blending mode of the layer to layer effects that modify opaque pixels, such as Inner Glow, Satin, Color Overlay, and Gradient Overlay.
 - Select Blend Clipped Layers As Group to apply the blending mode of the base layer to all layers in the clipping mask. Deselecting this option, which is always selected by default, maintains the original blending mode and appearance of each layer in the group.



Advanced blending options

A. Farm Logo and Paint Stroke layers, each with its own blending mode **B.** Blend Interior Effects As Group option selected **C.** Blend Clipped Layers As Group option selected

- Select Transparency Shapes Layers to restrict layer effects and knockouts to opaque areas of the layer. Deselecting this option, which is always selected by default, applies these effects throughout the layer.
 - Select Layer Mask Hides Effects to restrict layer effects to the area defined by the layer mask.
 - Select Vector Mask Hides Effects to restrict layer effects to the area defined by the vector mask.
- 4 Click OK.

Specify a tonal range for blending layers

The sliders in the Blending Options dialog box control which pixels from the active layer and the underlying visible layers appear in the final image. For example, you can drop dark pixels out of the active layer or force bright pixels from the underlying layers to show through. You can also define a range of partially blended pixels to produce a smooth transition between blended and unblended areas.

- 1 Double-click a layer thumbnail, choose Layer > Layer Style > Blending Options, or choose Add A Layer Style > Blending Options from the Layers panel menu.

Note: To view blending options for a text layer, choose Layer > Layer Style > Blending Options, or choose Blending Options from the Add A Layer Style button at the bottom of the Layers panel menu.

- 2 In the Advanced Blending area of the Layer Style dialog box, choose an option from the Blend If pop-up menu.
 - Choose Gray to specify a blending range for all channels.
 - Select an individual color channel (for example, red, green, or blue in an RGB image) to specify blending in that channel.
- 3 Use the This Layer and Underlying Layer sliders to set the brightness range of the blended pixels—measured on a scale from 0 (black) to 255 (white). Drag the white slider to set the high value of the range. Drag the black slider to set the low value of the range.

 To define a range of partially blended pixels, hold down Alt (Windows) or Option (Mac OS), and drag one half of a slider triangle. The two values that appear above the divided slider indicate the partial blending range.

Keep the following guidelines in mind when specifying blending ranges:

- Use the This Layer sliders to specify the range of pixels on the active layer that will blend, and therefore appear, in the final image. For example, if you drag the white slider to 235, pixels with brightness values higher than 235 will remain unblended and will be excluded from the final image.
- Use the Underlying Layer sliders to specify the range of pixels in the underlying visible layers that will blend in the final image. Blended pixels are combined with pixels in the active layer to produce composite pixels, whereas unblended pixels show through overlying areas of the active layer. For example, if you drag the black slider to 19, pixels with brightness values lower than 19 will remain unblended and will show through the active layer in the final image.

Layer effects and styles

About layer effects and styles

Photoshop provides a variety of effects—such as shadows, glows, and bevels—that change the appearance of a layer's contents. Layer effects are linked to the layer contents. When you move or edit the contents of the layer, the same effects are applied to the modified contents. For example, if you apply a drop shadow to a text layer and then add new text, the shadow is added automatically to the new text.

A layer style is one or more effects applied to a layer or layer group. You can apply one of the preset styles provided with Photoshop or create a custom style using the Layer Style dialog box. The layer effects icon  appears to the right of the layer's name in the Layers panel. You can expand the style in the Layers panel to view or edit the effects that compose the style.

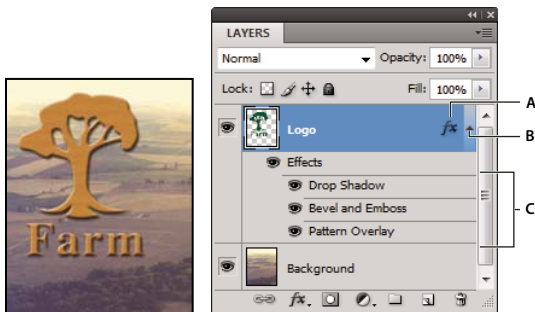

Layers panel showing layer with multiple effects applied
 A. Layer effects icon B. Click to expand and show layer effects C. Layer effects

When you save a custom style, it becomes a preset style. Preset styles appear in the Styles panel and can be applied to a layer or group with a single click.

Apply preset styles

You can apply preset styles from the Styles panel. The layer styles that come with Photoshop are grouped into libraries by function. For example, one library contains styles for creating web buttons; another library contains styles adding effects to text. To access these styles, you need to load the appropriate library. For information on loading and saving styles, see “[Create and manage preset styles](#)” on page 304.

Note: You cannot apply layer styles to a background, locked layer, or group.

Display the Styles panel

- ❖ Choose Window > Styles.

Apply a preset style to a layer

Normally, applying a preset style replaces the current layer style. However, you can add the attributes of a second style to those of the current style.

- ❖ Do one of the following:
 - Click a style in the Styles panel to apply it to the currently selected layers.
 - Drag a style from the Styles panel onto a layer in the Layers panel.
 - Drag a style from the Styles panel to the document window, and release the mouse button when the pointer is over the layer content to which you want to apply the style.

Note: Hold down Shift as you click or drag to add (rather than replace) the style to any existing effects on the destination layer.

- Choose Layer > Layer Style > Blending Options, and click the word *Styles* in the Layer Style dialog box (top item in the list on the left side of the dialog box). Click the style you want to apply, and click OK.
- When using a Shape tool or Pen tool in shape layers mode, select a style from the pop-up panel in the options bar before drawing the shape.

Apply a style from another layer

- In the Layers panel, Alt-drag (Windows) or Option-drag (Mac OS) the style from a layer’s effect list to copy it to another layer.
- In the Layers panel, click-drag the style from a layer’s effect list to move it to another layer.

Change how preset styles are displayed

- 1 Click the triangle in the Styles panel, Layer Style dialog box, or Layer Style pop-up panel in the options bar.
- 2 Choose a display option from the panel menu:
 - Text Only to view the layer styles as a list.
 - Small Thumbnail or Large Thumbnail to view the layer styles as thumbnails.
 - Small List or Large List to view the layer styles as a list, with a thumbnail of the selected layer style displayed.

Layer Style dialog box overview

You can edit styles applied to a layer or create new styles using the Layer Style dialog box.

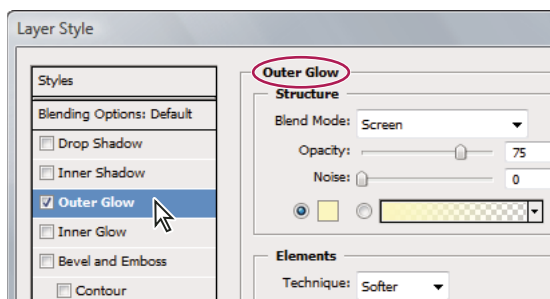

Layer Style dialog box. Click a check box to apply the current settings without displaying the effect's options. Click an effect name to display its options.

You can create custom styles using one or more of the following effects:

Drop Shadow Adds a shadow that falls behind the contents on the layer.

Inner Shadow Adds a shadow that falls just inside the edges of the layer's content, giving the layer a recessed appearance.

Outer Glow and Inner Glow Add glows that emanate from the outside or inside edges of the layer's content.

Bevel and Emboss Add various combinations of highlights and shadows to a layer.

Satin Applies interior shading that creates a satiny finish.

Color, Gradient, and Pattern Overlay Fills the layer's content with a color, gradient, or pattern.

Stroke Outlines the object on the current layer using color, a gradient, or a pattern. It is particularly useful on hard-edged shapes such as type.

Apply or edit a custom layer style

Note: You cannot apply layer styles to a background layer, a locked layer, or a group. To apply a layer style to a background layer, first convert it into a regular layer.

- 1 Select a single layer from the Layers panel.
- 2 Do one of the following:
 - Double-click the layer, outside the layer name or thumbnail.
 - Click the Add a Layer Style icon  at the bottom of the Layers panel and choose an effect from the list.
 - Choose an effect from the Layer > Layer Style submenu.

- To edit an existing style, double-click an effect displayed below the layer name in the Layers panel. (Click the triangle next to the Add a Layer Style icon  to display the effects contained in the style.)
- 3 Set effect options in the Layer Style dialog box. See “[Layer style options](#)” on page 301.
 - 4 Add other effects to the style, if desired. In the Layer Style dialog box, click the check box to the left of the effect name to add the effect without selecting it.

 You can edit multiple effects without closing the Layer Style dialog box. Click the name of an effect on the left side of the dialog box to display its options.

Layer style options

Altitude For the Bevel and Emboss effect, sets the height of the light source. A setting of 0 is equivalent to ground level, 90 is directly above the layer.

Angle Determines the lighting angle at which the effect is applied to the layer. You can drag in the document window to adjust the angle of a Drop Shadow, Inner Shadow, or Satin effect.

Anti-alias Blends the edge pixels of a contour or gloss contour. This option is most useful on small shadows with complicated contours.

Blend Mode Determines how the layer style blends with the underlying layers, which may or may not include the active layer. For example, an inner shadow blends with the active layer because the effect is drawn on top of that layer, but a drop shadow blends only with the layers beneath the active layer. In most cases, the default mode for each effect produces the best results. See

Choke Shrinks the boundaries of the matte of an Inner Shadow or Inner Glow prior to blurring.

Color Specifies the color of a shadow, glow, or highlight. You can click the color box and choose a color.

Contour With solid-color glows, Contour allows you to create rings of transparency. With gradient-filled glows, Contour allows you to create variations in the repetition of the gradient color and opacity. In beveling and embossing, Contour allows you to sculpt the ridges, valleys, and bumps that are shaded in the embossing process. With shadows, Contour allows you to specify the fade. For more information, see “[Modify layer effects with contours](#)” on page 303.

Distance Specifies the offset distance for a shadow or satin effect. You can drag in the document window to adjust the offset distance.

Depth Specifies the depth of a bevel. It also specifies the depth of a pattern.

Use Global Light This setting allows you to set one “master” lighting angle that is then available in all the layer effects that use shading: Drop Shadow, Inner Shadow, and Bevel and Emboss. In any of these effects, if Use Global Light is selected and you set a lighting angle, that angle becomes the global lighting angle. Any other effect that has Use Global Light selected automatically inherits the same angle setting. If Use Global Light is deselected, the lighting angle you set is “local” and applies only to that effect. You can also set the global lighting angle by choosing Layer Style > Global Light.

Gloss Contour Creates a glossy, metallic appearance. Gloss Contour is applied after shading a bevel or emboss.

Gradient Specifies the gradient of a layer effect. Click the gradient to display the Gradient Editor, or click the inverted arrow and choose a gradient from the pop-up panel. You can edit a gradient or create a new gradient using the Gradient Editor. You can edit the color or opacity in the Gradient Overlay panel the same way you edit them in the Gradient Editor. For some effects, you can specify additional gradient options. Reverse flips the orientation of the gradient, Align With Layer uses the bounding box of the layer to calculate the gradient fill, and Scale scales the application of the gradient. You can also move the center of the gradient by clicking and dragging in the image window. Style specifies the shape of the gradient.

Highlight or Shadow Mode Specifies the blending mode of a bevel or emboss highlight or shadow.

Jitter Varies the application of a gradient's color and opacity.

Layer Knocks Out Drop Shadow Controls the drop shadow's visibility in a semitransparent layer.

Noise Specifies the number of random elements in the opacity of a glow or shadow. Enter a value or drag the slider.

Opacity Sets the opacity of the layer effect. Enter a value or drag the slider.

Pattern Specifies the pattern of a layer effect. Click the pop-up panel and choose a pattern. Click the New Preset button  to create a new preset pattern based on the current settings. Click Snap To Origin to make the origin of the pattern the same as the origin of the document (when Link With Layer is selected), or to place the origin at the upper-left corner of the layer (if Link With Layer is deselected). Select Link With Layer if you want the pattern to move along with the layer as the layer moves. Drag the Scale slider or enter a value to specify the size of the pattern. Drag a pattern to position it in the layer; reset the position by using the Snap To Origin button. The Pattern option is not available if no patterns are loaded.

Position Specifies the position of a stroke effect as Outside, Inside, or Center.

Range Controls which portion or range of the glow is targeted for the contour.

Size Specifies the radius and size of blur or the size of the shadow.

Soften Blurs the results of shading to reduce unwanted artifacts.

Source Specifies the source for an inner glow. Choose Center to apply a glow that emanates from the center of the layer's content, or Edge to apply a glow that emanates from the inside edges of the layer's content.

Spread Expands the boundaries of the matte prior to blurring.

Style Specifies the style of a bevel: Inner Bevel creates a bevel on the inside edges of the layer contents; Outer Bevel creates a bevel on the outside edges of the layer contents; Emboss simulates the effect of embossing the layer contents against the underlying layers; Pillow Emboss simulates the effect of stamping the edges of the layer contents into the underlying layers; and Stroke Emboss confines embossing to the boundaries of a stroke effect applied to the layer. (The Stroke Emboss effect is not visible if no stroke is applied to the layer.)

Technique Smooth, Chisel Hard, and Chisel Soft are available for bevel and emboss effects; Softer and Precise apply to Inner Glow and Outer Glow effects.

- **Smooth** Blurs the edges of a matte slightly and is useful for all types of mattes, whether their edges are soft or hard. It does not preserve detailed features at larger sizes.
- **Chisel Hard** Uses a distance measurement technique and is primarily useful on hard-edged mattes from anti-aliased shapes such as type. It preserves detailed features better than the Smooth technique.
- **Chisel Soft** Uses a modified distance measurement technique and, although not as accurate as Chisel Hard, is more useful on a larger range of mattes. It preserves features better than the Smooth technique.
- **Softer** Applies a blur and is useful on all types of mattes, whether their edges are soft or hard. At larger sizes, Softer does not preserve detailed features.
- **Precise** Uses a distance measurement technique to create a glow and is primarily useful on hard-edged mattes from anti-aliased shapes such as type. It preserves features better than the Softer technique.

Texture Applies a texture. Use Scale to scale the size of the texture. Select Link With Layer if you want the texture to move along with the layer as the layer moves. Invert inverts the texture. Depth varies the degree and direction (up/down) to which the texturing is applied. Snap To Origin makes the origin of the pattern the same as the origin of the document (if Link With Layer is deselected) or places the origin in the upper-left corner of the layer (if Link With Layer is selected). Drag the texture to position it in the layer.

Modify layer effects with contours

When you create custom layer styles, you can use contours to control the shape of Drop Shadow, Inner Shadow, Inner Glow, Outer Glow, Bevel and Emboss, and Satin effects over a given range. For example, a Linear contour on a Drop Shadow causes the opacity to drop off in a linear transition. Use a Custom contour to create a unique shadow transition.

You can select, reset, delete, or change the preview of contours in the Contour pop-up panel and Preset Manager.

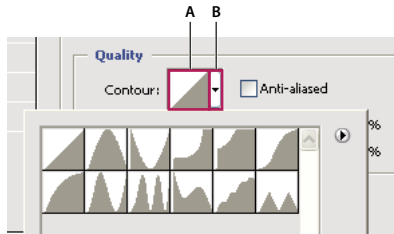

Detail of Layer Style dialog box for Drop Shadow effect

A. Click to display the Contour Editor dialog box. B. Click to display the pop-up panel.

Create a custom contour

- 1 Select the Drop Shadow, Inner Shadow, Inner Glow, Outer Glow, Bevel and Emboss, Contour, or Satin effect in the Layer Style dialog box.
- 2 Click the contour thumbnail in the Layer Style dialog box.
- 3 Click the contour to add points, and drag to adjust the contour. Or enter values for Input and Output.
- 4 To create a sharp corner instead of a smooth curve, select a point and click Corner.
- 5 To save the contour to a file, click Save and name the contour.
- 6 To store a contour as a preset, choose New.
- 7 Click OK. New contours are added at the bottom of the pop-up panel.

Load a contour

- ❖ Click the contour in the Layer Style dialog box, and in the Contour Editor dialog box, and then choose Load. Go to the folder containing the contour library you want to load and click Open.

Delete a contour

- ❖ Click the inverted arrow next to the currently selected contour to view the pop-up panel. Press Alt (Windows) or Option (Mac OS), and click the contour you want to delete.

Set a global lighting angle for all layers

Using global light gives the appearance of a common light source shining on the image.

- ❖ Do one of the following:
 - Choose Layer > Layer Style > Global Light. In the Global Light dialog box, enter a value or drag the angle radius to set the angle and altitude, and click OK.
 - In the Layer Style dialog box for Drop Shadow, Inner Shadow, or Bevel, select Use Global Light. For Angle, enter a value or drag the radius, and click OK.

The global lighting applies to each layer effect that uses the global lighting angle.



Display or hide layer styles

When a layer has a style, an “fx” icon  appears to the right of the layer’s name in the Layers panel.

Hide or show all layer styles in an image

- ❖ Choose Layer > Layer Style > Hide All Effects or Show All Effects.

Expand or collapse layer styles in the Layers panel

- ❖ Do one of the following:
 - Click the triangle  next to the Add a Layer Style icon  to expand the list of layer effects applied to that layer.
 - Click the triangle to collapse the layer effects.
 - To expand or collapse all of the layer styles applied within a group, hold down Alt (Windows) or Option (Mac OS), and click the triangle or inverted triangle for the group. The layer styles applied to all layers within the group expand or collapse correspondingly.

Create and manage preset styles

You can create a custom style and save it as a preset, which is then available from the Styles panel. You can save preset styles in a library and load or remove them from the Styles panel as you need them.

Create a new preset style

- 1 From the Layers panel, select the layer containing the style that you want to save as a preset.
- 2 Do one of the following:
 - Click an empty area of the Styles panel.
 - Click the Create New Style button at the bottom of the Styles panel.
 - Choose New Style from the Styles panel menu.
 - Choose Layer > Layer Style > Blending Options, and click New Style in the Layer Style dialog box.
- 3 Enter a name for the preset style, set style options, and click OK.

Rename a preset style

- ❖ Do one of the following:
 - Double-click a style in the Styles panel. If the Styles panel is set to display styles as thumbnails, enter a new name in the dialog box and click OK. Otherwise, type a new name directly in the Styles panel and press Enter (Windows) or Return (Mac OS).
 - Select a style in the Styles area of the Layer Style dialog box. Then choose Rename Style from the pop-up menu, enter a new name, and click OK.
 - When using a shape or Pen tool, select a style from the Style pop-up panel in the options bar. Then choose Rename Style from the pop-up panel menu.

Delete a preset style

- ❖ Do one of the following:
 - Drag a style to the Delete icon  at the bottom of the Styles panel.
 - Press Alt (Windows) or Option (Mac OS), and click the layer style in the Styles panel.

- Select a style in the Styles area of the Layer Style dialog box. (See “[Apply preset styles](#)” on page 299.) Then choose Delete Style from the pop-up menu.
- When using a shape or Pen tool, select a style from the Layer Style pop-up panel in the options bar. Then choose Delete Style from the pop-up panel menu.

Save a set of preset styles as a library

1 Do one of the following:

- Choose Save Styles from the Styles panel menu.
- Select Styles on the left side of the Layer Style dialog box. Then choose Save Styles from the pop-up menu.
- When using a shape or Pen tool, click the layer style thumbnail in the options bar. Then choose Save Styles from the pop-up panel menu.

2 Choose a location for the style library, enter a file name, and click Save.

You can save the library anywhere. However, if you place the library file in the Presets/Styles folder inside the default presets location, the library name will appear at the bottom of the Styles panel menu when you restart the application.

Note: You can also use the Preset Manager to rename, delete, and save libraries of preset styles.

Load a library of preset styles

1 Click the triangle in the Styles panel, Layer Style dialog box, or Layer Style pop-up panel in the options bar.

2 Do one of the following:

- Choose Load Styles to add a library to the current list. Then select the library file you want to use, and click Load.
- Choose Replace Styles to replace the current list with a different library. Then select the library file you want to use, and click Load.
- Choose a library file (displayed at the bottom of the panel menu). Then click OK to replace the current list, or click Append to append the current list.

3 To return to the default library of preset styles, choose Reset Styles. You can either replace the current list or append the default library to the current list.

Note: You can also use the Preset Manager to load and reset style libraries. See “[About the Preset Manager](#)” on page 41.

Copy layer styles

Copying and pasting styles is an easy way to apply the same effects to multiple layers.

Copy layer styles between layers

1 From the Layers panel, select the layer containing the style you want to copy.

2 Choose Layer > Layer Style > Copy Layer Style.

3 Select the destination layer from the panel, and choose Layer > Layer Style > Paste Layer Style.

The pasted layer style replaces the existing layer style on the destination layer or layers.

Copy layer styles between layers by dragging

❖ Do one of the following:

- In the Layers panel, Alt-drag (Windows) or Option-drag (Mac OS) a single layer effect from one layer to another to duplicate the layer effect, or drag the Effects bar from one layer to another to duplicate the layer style.

- Drag one or more layer effects from the Layers panel to the image to apply the resulting layer style to the highest layer in the Layers panel that contains pixels at the drop point.

Scale a layer effect

A layer style may have been fine-tuned for a target resolution and features of a given size. Using Scale Effects allows you to scale the effects in the layer style without scaling the object to which the layer style is applied.

- 1 Select the layer in the Layers panel.
- 2 Choose Layer > Layer Style > Scale Effects.
- 3 Enter a percentage or drag the slider.
- 4 Select Preview to preview the changes in the image.
- 5 Click OK.



Remove layer effects

You can remove an individual effect from a style applied to a layer, or remove the entire style from the layer.

Remove an effect from a style

- 1 In the Layers panel, expand the layer style to see its effects.
- 2 Drag the effect to the Delete icon .

Remove a style from a layer

- 1 In the Layers panel, select the layer containing the style you want to remove.
- 2 Do one of the following:
 - In the Layers panel, drag the Effects bar to the Delete icon .
 - Choose Layer > Layer Style > Clear Layer Style.
 - Select the layer, and then click the Clear Style button  at the bottom of the Styles panel.

Convert a layer style to image layers

To customize or fine-tune the appearance of layer styles, you can convert the layer styles to regular image layers. After you convert a layer style to image layers, you can enhance the result by painting or applying commands and filters. However, you can no longer edit the layer style on the original layer, and the layer style no longer updates as you change the original image layer.

Note: The layers produced by this process may not result in artwork that exactly matches the version using layer styles. You may see an alert when you create the new layers.

- 1 In the Layers panel, select the layer containing the layer style that you want to convert.
- 2 Choose Layer > Layer Style > Create Layers.

You can now modify and restack the new layers in the same way as regular layers. Some effects—for example, Inner Glow—convert to layers within a clipping mask.

Adjustment and fill layers

About adjustment layers and fill layers

An adjustment layer applies color and tonal adjustments to your image without permanently changing pixel values. For example, rather than making a Levels or Curves adjustment directly to your image, you can create a Levels or Curves adjustment layer. The color and tonal adjustments are stored in the adjustment layer and apply to all the layers below it. You can discard your changes and restore the original image at any time.

Adjustment layer choices match the commands available in the Adjustments panel. Choosing an adjustment layer from the Layers panel displays the corresponding command settings controls in the Adjustments panel. If the Adjustments panel is closed, you can open it by double-clicking the adjustment layer thumbnail in the Layers panel.

Fill layers let you fill a layer with a solid color, a gradient, or a pattern. Unlike adjustment layers, fill layers do not affect the layers underneath them.

Adjustment layers provide the following advantages:

- **Nondestructive edits.** You can try different settings and re-edit the adjustment layer at any time. You can also reduce the effect of the adjustment by lowering the opacity of the adjustment layer.
- **Selective editing.** Paint on the adjustment layer's image mask to apply an adjustment to part of an image. Later you can control which parts of the image are adjusted by re-editing the layer mask. You can vary the adjustment by painting on the mask with different tones of gray.
- **Ability to apply adjustments to multiple images.** Copy and paste adjustment layers between images to apply the same color and tonal adjustments.

Adjustment layers increase the image's file size, though less than other layers. If you are working with many layers, you may want to reduce file size by merging the adjustment layers into the pixel content layers. Adjustment layers have many of the same characteristics as other layers. You can adjust their opacity and blending mode, and you can group them to apply the adjustment to specific layers. You can turn their visibility on and off to apply their effect or to preview the effect.



Original (left); adjustment layer applied to barn only (center), which brings out detail in the barn; and adjustment layer applied to entire image (right), which lightens the entire image and pixelates the clouds

An adjustment layer affects all the layers below it: you can correct multiple layers by making a single adjustment, rather than adjusting each layer separately.

See also

[“Color and tonal adjustments”](#) on page 149

Create adjustment and fill layers

Adjustment layers and fill layers have the same opacity and blending mode options as image layers. You can rearrange, delete, hide, and duplicate them just as you do image layers. By default, adjustment layers and fill layers have layer masks, as indicated by the mask icon to the left of the layer thumbnail. To create adjustment layers without layer masks, deselect Add Mask by Default in the Adjustments panel menu.

 To confine the effects of the adjustment layer or fill layer to a selected area, make a selection, create a closed path and select it, or select an existing closed path. When you use a selection, you create an adjustment layer or fill layer confined by a layer mask. When you use a path, you create an adjustment layer or fill layer confined by a vector mask.

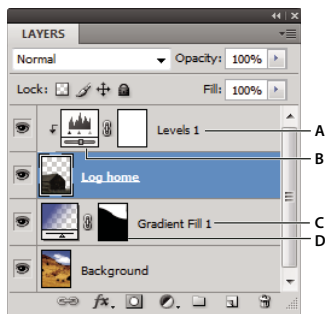



Adjustment and fill layers

A. Adjustment layer confined to Log Home layer only B. Layer thumbnail C. Fill layer D. Layer mask

Create an adjustment layer

For information on specific adjustment layer options, see “[Color and tonal adjustments](#)” on page 149.

- ❖ Do one of the following:
 - Click an adjustment icon or select an adjustment preset in the Adjustments panel.
 - Click the New Adjustment Layer button  at the bottom of the Layers panel, and choose an adjustment layer type.
 - Choose Layer > New Adjustment Layer, and choose an option. Name the layer, set layer options, and click OK.

 To confine the effects of an adjustment layer to a group of layers, create a clipping mask consisting of those layers. You can place the adjustment layers in or at the base of the clipping mask. The resulting adjustment is confined to the layers inside the group. (Alternatively, you can create a layer group that uses any blending mode other than Pass Through.)

Create a fill layer

- ❖ Do one of the following:
 - Choose Layer > New Fill Layer, and choose an option. Name the layer, set layer options, and click OK.
 - Click the New Adjustment Layer button  at the bottom of the Layers panel, and choose a fill layer type.

Solid Color Fills the adjustment layer with the current foreground color. Use the Color Picker to select a different a fill color.

Gradient Click the gradient to display the Gradient Editor, or click the inverted arrow and choose a gradient from the pop-up panel. Set additional options if desired. Style specifies the shape of the gradient. Angle specifies the angle at which the gradient is applied. Scale changes the size of the gradient. Reverse flips the orientation of the gradient. Dither reduces banding by applying dithering to the gradient. Align With Layer uses the bounding box of the layer to calculate the gradient fill. You can drag in the image window to move the center of the gradient.

Pattern Click the pattern, and choose a pattern from the pop-up panel. Click Scale, and enter a value or drag the slider. Click Snap To Origin to make the origin of the pattern the same as the origin of the document. Select Link With Layer

if you want the pattern to move along with the layer as the layer moves. When Link With Layer is selected, you can drag in the image to position the pattern while the Pattern Fill dialog box is open.

Edit an adjustment or fill layer

You can edit an adjustment or fill-layer setting, or replace it with a different adjustment or fill type.

You can also edit the mask of an adjustment layer or fill layer to control the effect that the layer has on the image. By default, all areas of an adjustment or fill layer are “unmasked” and are therefore visible. (See “[About layer and vector masks](#)” on page 319.)

Change adjustment and fill layer options

- 1 Do one of the following:
 - Double-click the adjustment or fill-layer thumbnail in the Layers panel.
 - Choose Layer > Layer Content Options.
- 2 Make the desired changes in the Adjustments panel.

Note: Inverted adjustment layers do not have editable settings.

Merging adjustment layers or fill layers

You can merge an adjustment or fill layer several ways: with the layer below it, with the layers in its own grouped layer, with other selected layers, and with all other visible layers. You cannot, however, use an adjustment layer or fill layer as the target layer for a merge. When you merge an adjustment layer or fill layer with the layer below it, the adjustments are rasterized and become permanently applied within the merged layer. You can also rasterize a fill layer without merging it. (See “[Rasterize layers](#)” on page 291.)

Adjustment layers and fill layers whose masks contain only white values do not add significantly to the file size, so it is not necessary to merge these adjustment layers to conserve file space.

Nondestructive editing

About nondestructive editing

Nondestructive editing allows you to make changes to an image without overwriting the original image data, which remains available in case you want to revert to it. Because nondestructive editing doesn’t remove data from an image, the image quality doesn’t degrade when you make edits. You can perform nondestructive editing in Photoshop in several ways:

Working with adjustment layers Adjustment layers apply color and tonal adjustments to an image without permanently changing pixel values.

Transforming with Smart Objects Smart Objects enable nondestructive scaling, rotating, and warping.

Filtering with Smart Filters Filters applied to Smart Objects become Smart Filters and allow for nondestructive filter effects.

Adjusting variations, shadows, and highlights with Smart Objects Shadow/Highlight and Variations commands can be applied to a Smart Object as Smart Filters.

Retouching on a separate layer Clone Stamp, Healing Brush, and Spot Healing Brush tools let you retouch non-destructively on a separate layer. Be sure to select Sample All Layers from the options bar (select Ignore Adjustment Layers to ensure that adjustment layers won't affect the separate layer twice). You can discard unsatisfactory retouching, if necessary.

Editing in Camera Raw Adjustments to batches of raw, JPEG, or TIFF images preserve the original image data. Camera Raw stores adjustment settings on a per-image basis separately from the original image files.

Opening Camera Raw files as Smart Objects Before you can edit Camera Raw files in Photoshop, you must configure settings for them with Camera Raw. Once you edit a Camera Raw file in Photoshop, you can't reconfigure Camera Raw settings without losing the changes. Opening Camera Raw files in Photoshop as Smart Objects enables you to reconfigure Camera Raw settings at any time, even after you edit the file.

Cropping non-destructively After you create a cropping rectangle with the Crop tool, select Hide from the options bar to preserve the cropped area in a layer. Restore the cropped area anytime by choosing Image > Reveal All or by dragging the Crop tool beyond the edge of the image. The Hide option is unavailable for images that contain only a background layer.

Masking Layer and vector masks are nondestructive because you can re-edit the masks without losing the pixels they hide. Filter masks let you mask out the effects of Smart Filters on Smart Object layers.

See also

[“About Camera Raw”](#) on page 79

[“About adjustment layers and fill layers”](#) on page 307

[“Crop images”](#) on page 192

[“About layer and vector masks”](#) on page 319

[“Retouch with the Clone Stamp tool”](#) on page 197

[“Retouch with the Healing Brush tool”](#) on page 200

[“Retouch with the Spot Healing Brush tool”](#) on page 201

About Smart Objects

Smart Objects are layers that contain image data from raster or vector images, such as Photoshop or Illustrator files. Smart Objects preserve an image's source content with all its original characteristics, enabling you to perform nondestructive editing to the layer.

You can create Smart objects using several methods: by using the Open As Smart Object command; placing a file, pasting data from Illustrator; or converting one or more Photoshop layers to Smart Objects.

With Smart Objects, you can:

- Perform nondestructive transforms. You can scale, rotate, skew, distort, perspective transform, or warp a layer without losing original image data or quality because the transforms don't affect the original data.
- Work with vector data, such as vector artwork from Illustrator, that otherwise would be rasterized in Photoshop.
- Perform nondestructive filtering. You can edit filters applied to Smart Objects at any time.
- Edit one Smart Object and automatically update all its linked instances.
- Apply a layer mask that's either linked or unlinked to the Smart Object layer

You can't perform operations that alter pixel data—such as painting, dodging, burning, or cloning—directly to a Smart Object layer, unless it is first converted into a regular layer, which will be rasterized. To perform operations that alter pixel data, you can edit the contents of a Smart Object, clone a new layer above the Smart Object layer, edit duplicates of the Smart Object, or create a new layer.

Note: When you transform a Smart Object that has a Smart Filter applied to it, Photoshop turns off filter effects while the transform is being performed. Filter effects are applied again after the transform is complete. See “About Smart Filters” on page 313.

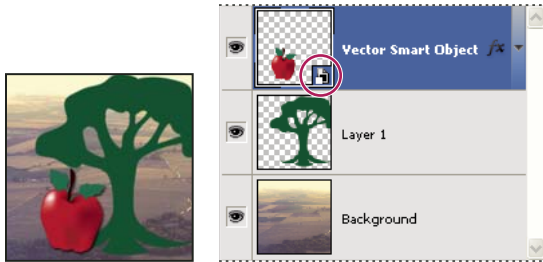

Regular layer and Smart Object in Layers panel. Icon in lower right corner of thumbnail indicates Smart Object.

For a video on editing and merging images from Lightroom, see www.adobe.com/go/lrvid4121_ps.

Create Smart Objects

❖ Do any of the following:

- Choose File > Open As Smart Object, select a file, and click Open.
- Choose File > Place to import files as Smart Objects into an open Photoshop document.

💡 Although you can place JPEG files, it's better to place PSD, TIFF, or PSB files because you can add layers, modify pixels, and resave the file without loss. (Saving a modified JPEG file requires you to flatten new layers and recompress the image, causing image quality degradation).

- Choose Layer > Smart Object > Convert to Smart Object to convert a selected layer into a Smart Object.
- In Bridge, choose File > Place > In Photoshop to import a file as a Smart Object into an open Photoshop document.

💡 An easy way to work with camera raw files is to open them as Smart Objects. You can double-click the Smart Object layer containing the raw file at any time to adjust the Camera Raw settings.

- Select one or more layers and choose Layer > Smart Objects > Convert To Smart Object. The layers are bundled into one Smart Object. Clipping masks aren't retained when you group layers into a Smart Object.
- Drag PDF or Adobe Illustrator layers or objects into a Photoshop document.
- Paste artwork from Illustrator into a Photoshop document, and choose Smart Object in the Paste dialog box. For the greatest flexibility, enable both PDF and AICB (No Transparency Support) in the File Handling & Clipboard section of the Preferences dialog box in Adobe Illustrator.

See also

“Place a file in Photoshop” on page 69

“Paste Adobe Illustrator art into Photoshop” on page 70

Duplicate a Smart Object

- ❖ In the Layers panel, select a Smart Object layer, and do one of the following:
 - To create a duplicate Smart Object that is linked to the original, choose Layer > New > Layer Via Copy, or drag the Smart Object layer to the Create A New Layer icon at the bottom of the Layers panel. Edits you make to the original affect the copy and vice versa.
 - To create a duplicate Smart Object that isn't linked to the original, choose Layer > Smart Objects > New Smart Object Via Copy. Edits you make to the original don't affect the copy.

A new Smart Object appears in the Layers panel with the same name as the original and “copy” as a suffix.

Edit the content of a Smart Object

When you edit a Smart Object, the source content is opened in either Photoshop (if the content is raster data or a camera raw file) or Illustrator (if the content is vector PDF). When you save changes to the source content, the edits appear in all linked instances of the Smart Object in the Photoshop document.

- 1 Select the Smart Object from the Layers panel, and do one of the following:
 - Choose Layer > Smart Objects > Edit Contents.
 - Double-click the Smart Objects thumbnail in the Layers panel.
- 2 Click OK to close the dialog box.
- 3 Make edits to the source content file, then choose File > Save.

Photoshop updates the Smart Object to reflect the changes you made. (If you don't see the changes, make the Photoshop document containing the Smart Object active).

Replace the contents of a Smart Object

You can update the image data in one or multiple (if the Smart Objects are linked) instances of a Smart Object.

Note: When you replace a Smart Object, any scaling, warping, or effects that you applied to the first Smart Object are maintained.

- 1 Select the Smart Object, and choose Layer > Smart Objects > Replace Contents.
- 2 Navigate to the file you want to use, and click Place.
- 3 Click OK.

The new content is placed in the Smart Object. Linked Smart Objects are also updated.

See also

“[Place a file in Photoshop](#)” on page 69

Export the contents of a Smart Object

- 1 Select the Smart Object from the Layers panel, and choose Layer > Smart Objects > Export Contents.
- 2 Choose a location for the contents of the Smart Object, then click Save.

Photoshop exports the Smart Object in its original placed format (JPEG, AI, TIF, PDF, or other formats). If the Smart Object was created from layers, it is exported in PSB format.

Convert a Smart Object to a layer

Converting a Smart Object to a regular layer rasterizes the content at the current size. Convert a Smart Object to a regular layer only if you no longer need to edit the Smart Object data. Transforms, warps, and filters applied to a Smart Object are no longer editable after the Smart Object is rasterized.

- ❖ Select the Smart Object, and choose Layer > Rasterize > Smart Object.

 *If you want to re-create the Smart Object, reselect its original layers and start from scratch. The new Smart Object won't retain transforms you applied to the original Smart Object.*

About Smart Filters

Any filter applied to a Smart Object is a Smart Filter. Smart Filters appear in the Layers panel below the Smart Object layer to which they are applied. Because you can adjust, remove, or hide Smart Filters, they are nondestructive.

You can apply any Photoshop filter (that have been enabled to work with Smart Filters)—except for Extract, Liquify, Pattern Maker, and Vanishing Point—as a Smart Filter. In addition, you can apply the Shadow/Highlight and Variations adjustments as Smart Filters.

To work with Smart Filters, select a Smart Object layer, choose a filter, and then set filter options. After you apply a Smart Filter, you can adjust, reorder, or delete it.

To expand or collapse the view of Smart Filters, click the triangle next to the Smart Filter icon, displayed to the right of the Smart Object layer in the Layers panel. (This technique also shows or hides Layer Style.) Or, choose Layers panel Options from the Layers panel menu, then select Expand New Effects in the dialog box.

Use filter masks to selectively mask Smart Filter effects. See “[Mask Smart Filters](#)” on page 315.

Note: *If you open a file containing a Smart Object layer with a Smart Filter in Photoshop, Photoshop retains the Smart Filter effects when you open it, including filter masks. However, if you subsequently edit the Smart Object layer, Photoshop won't display the layer's Smart Filters.*

Apply a Smart Filter

1 Do one of the following:

- To apply a Smart Filter to an entire Smart Object layer, select the layer in the Layers panel.
- To constrain the effects of the Smart Filter to a selected area of a Smart Object layer, make a selection.
- To apply a Smart Filter to a regular layer, select the layer, and choose Filter > Convert For Smart Filters, and click OK.

2 Do one of the following:

- Choose a filter from the Filter menu. You can choose any filter, including third-party filters that support Smart Filters, except Extract, Liquify, Pattern Maker, and Vanishing Point.
- Choose Image > Adjustments > Shadow/Highlight or Image > Adjustments > Variations.

Note: *If you apply one or more filters using the Filter Gallery, they appear as a group in the Layers panel named “Filter Gallery.” You can't rearrange filters in a Filter Gallery. You can edit individual filters by double-clicking a Filter Gallery entry.*

3 Set filter options and click OK.

The Smart Filter appears under the Smart Filters line in the Layers panel beneath the Smart Object layer. If you see a warning icon next to a Smart Filter in the Layers panel, the filter doesn't support the image's color mode or depth.

After you apply a Smart Filter, you can drag it (or an entire group of Smart Filters) onto another Smart Object layer in the Layers panel; press Alt-drag (Windows) or Option-drag (Mac OS) Smart Filters. You can't drag Smart Filters onto regular layers.

For a video on applying smart filters, see www.adobe.com/go/vid0004.

Edit a Smart Filter

If a Smart Filter contains editable settings, you can edit it at any time. You can also edit blending options for Smart Filters.

Note: When you edit a Smart Filter, you can't preview filters stacked above it. After you finish editing the Smart Filter, Photoshop again displays the filters stacked above it.

See also

"List of blending modes" on page 347

"Specify opacity for a layer or group" on page 294

Edit Smart Filter settings



- 1 Double-click the Smart Filter in the Layers panel.
- 2 Set filter options, and click OK.

Edit Smart Filter blending options

Editing Smart Filter blending options is similar to using the Fade command when applying a filter to a traditional layer.

- 1 Double-click the Edit Blending Options icon  next to the Filter in the Layers panel.
- 2 Set blending options, and click OK.

Hide Smart Filters

- ❖ Do one of the following:
 - To hide a single Smart Filter, click the eye icon  next to the Smart Filter in the Layers panel. To show the Smart Filter, click in the column again.
 - To hide all Smart Filters applied to a Smart Object layer, click the eye icon  next to the Smart Filters line in the Layers panel. To show the Smart Filters, click in the column again.

Reorder, duplicate, or delete Smart Filters

You can reorder Smart Filters in the Layers panel, duplicate them, or delete Smart Filters if you no longer want to apply them to a Smart Object.

Reorder Smart Filters

- ❖ In the Layers panel, drag a Smart Filter up or down in the list. You can't reorder Smart Filters applied from the Filter Gallery.

Photoshop applies Smart Filters from the bottom up.

Duplicate Smart Filters

- ❖ In the Layers panel, Alt-drag (Windows) or Option-drag (Mac OS) the Smart Filter from one Smart Object to another, or to a new location in the Smart Filters list.

Note: To duplicate all Smart Filters, Alt-drag (Windows) or Option-drag (Mac OS) the Smart Filters icon that appears next to the Smart Object layer.

Delete Smart Filters

- To delete an individual Smart Filter, drag it to the Delete icon  at the bottom of the Layers panel.
- To delete all Smart Filters applied to a Smart Object layer, select the Smart Object layer and choose Layer > Smart Filter > Clear Smart Filters.

Mask Smart Filters

When you apply a Smart Filter to a Smart Object, Photoshop displays an empty (white) mask thumbnail on the Smart Filters line in the Layers panel under the Smart Object. By default, this mask shows the entire filter effect. (If you made a selection before applying the Smart Filter, Photoshop displays the appropriate mask instead of an empty mask on the Smart Filters line in the Layers panel.)

Use filter masks to selectively mask Smart Filters. When you mask Smart Filters, the masking applies to all Smart Filters—you can't mask individual Smart Filters.

Filter masks work much like layer masks, and you can use many of the same techniques with them. Like layer masks, filter masks are stored as alpha channels in the Channels panel, and you can load their boundaries as a selection.

Like layer masks, you can paint on a filter mask. Areas of the filter that you paint in black are hidden; areas you paint in white are visible; and areas you paint in shades of gray appear in various levels of transparency.

Use the controls in the Masks panel to change the filter mask density, add feathering to the edges of the mask, or invert the mask.

Note: By default, layer masks are linked to regular layers or Smart Object layers. When you move the layer mask or the layer using the Move tool, they move as a unit.

See also

[“Select and display the layer mask channel”](#) on page 323

[“Load a layer or layer mask's boundaries as a selection”](#) on page 325

Mask Smart Filter effects

- 1 Click the filter mask thumbnail in the Layers panel to make it active.

A border appears around the mask thumbnail.

- 2 Select any of the editing or painting tools.

- 3 Do one of the following:

- To hide portions of the filter, paint the mask with black.
- To show portions of the filter, paint the mask with white.
- To make the filter partially visible, paint the mask with gray.



You can also apply image adjustments and filters to filter masks.

Change filter mask opacity or feather mask edges

- 1 Click the filter mask thumbnail or select the Smart Object layer in the Layers panel, and then click the Filter Mask button in the Masks panel.
- 2 In the Masks panel, drag the Density slider to adjust the mask opacity, and the Feathering slider to apply feathering to the mask edges. See “[Change mask opacity or refine edges](#)” on page 321.

Note: The Mask Edge option is not available for filter masks.

Invert a filter mask

- ❖ Click the filter mask thumbnail in the Layers panel, then click Invert in the Masks panel.

Display only the filter mask

- ❖ Alt-click (Windows) or Option-click (Mac OS) the filter mask thumbnail in the Layers panel. To show the Smart Object layer, Alt-click or Option-click the filter mask thumbnail again.

Move or copy filter masks

- To move the mask to another Smart Filter Effect, drag the mask to the other Smart Filter Effect.
- To copy the mask, Alt-drag (Windows) or Option-drag (Mac OS) the mask to another Smart Filter Effect.

Disable a filter mask

- ❖ Do one of the following:
 - Shift-click the filter mask thumbnail in the Layers panel.
 - Click the filter mask thumbnail in the Layers panel, then click the Disable/Enable Mask button  in the Masks panel.
 - Choose Layer > Smart Filter > Disable Filter Mask.

A red X appears over the filter mask thumbnail when the mask is disabled, and the Smart Filter appears without masking. To re-enable the mask, Shift-click the Smart Filter mask thumbnail again.

Delete a Smart Filter mask

- Click the filter mask thumbnail in the Layers panel, then click the Delete icon  in the Masks panel.
- Drag the filter mask thumbnail in the Layers panel to the Delete icon.
- Select the Smart Filter Effect, and choose Layer > Smart Filters > Delete Filter Mask.

Add a filter mask

If you delete a filter mask, you can subsequently add another mask.

- To add an empty mask, select the Smart Object layer, and then click the Filter Mask button in the Masks panel.
- To add a mask based on a selection, make a selection, and then right-click (Windows) or Control-click (Mac OS) the Smart Filters line in the Layers panel, and choose Add Filter Mask.

Layer comps

About layer comps

Designers often create multiple compositions or *comps* of a page layout to show clients. Using layer comps, you can create, manage, and view multiple versions of a layout in a single Photoshop file.

A layer comp is a snapshot of a state of the Layers panel. Layer comps record three types of layer options:

- Layer visibility—whether a layer is showing or hidden.
- Layer position in the document.
- Layer appearance—whether a layer style is applied to the layer and the layer’s blending mode.

Note: Unlike layer effects, Smart Filter settings cannot be changed across layer comps. Once a Smart Filter is applied to a layer, it appears in all layer comps for the image.

You can export layer comps to separate files, to a single PDF, or to a web photo gallery.

Choose Window > Layer Comps to show the panel.

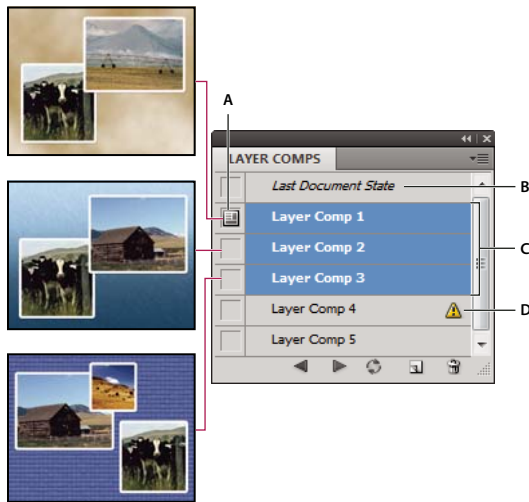

Layer Comps panel

A. Apply Layer Comp icon B. Last Document State C. Selected comps D. Layer Comp Cannot Be Fully Restored icon





Create a layer comp

- 1 Choose Window > Layer Comps to display the Layer Comps panel.
- 2 Click the Create New Layer Comp button at the bottom of the Layer Comps panel. The new comp reflects the current state of layers in the Layers panel.
- 3 In the New Layer Comp dialog box, name the comp, add descriptive comments, and choose options to apply to layers: Visibility, Position, and Appearance.
- 4 Click OK. Any new comp preserves the options you chose for the previous one, so you don’t have to make these choices again if you want the comps to be identical.



To duplicate a comp, select a comp in the Layer Comps panel and drag the comp to the New Comps button.

Apply and view layer comps

- ❖ Do any of the following:
 - To view a layer comp, you first need to apply it in the document. In the Layer Comp panel, click the Apply Layer Comp icon  next to a selected comp.
 - To cycle through a view of all the layer comps, use the Previous  and Next  buttons at the bottom of the panel.
 - To cycle through a view of selected comps, select the comps in the Layer Comps panel, and then click the Next and Previous buttons at the bottom of the panel. This cycles through only the comps you selected.
 - To restore the document to its state before you chose a layer comp, click the Apply Layer Comp icon  next to Last Document State at the top of the Layer Comp panel.

Change and update a layer comp

If you change the configuration of a layer comp, you need to update it.

- 1 Select the layer comp in the Layer Comps panel.
- 2 Make changes to the layer's visibility, position, or style. You may need to change the layer comp's options to record these changes.
- 3 To change your comp options, select Layer Comp Options from the panel menu and select additional options to record layer position and style.
- 4 Click the Update Layer Comp button  at the bottom of the panel.

Clear layer comp warnings

Certain actions create a state where the layer comp can no longer be fully restored. This happens when you delete a layer, merge a layer, or convert a layer to a background. In such instances, a caution icon  appears next to the layer comp name.

- ❖ Do one of the following:
 - Ignore the warning, which may result in the loss of one or more layers. Other saved parameters may be preserved.
 - Update the comp, which results in the loss of the previously captured parameters, but brings the comp up to date.
 - Click the caution icon to see the message explaining that the layer comp can't be restored properly. Choose Clear to remove the alert icon and leave the remaining layers unchanged.
 - Right-click (Windows) or Control-click (Mac OS) the caution icon to see the pop-up menu that lets you choose either the Clear Layer Comp Warning or the Clear All Layer Comp Warnings command.

Delete a layer comp

- ❖ Do one of the following:
 - Select the layer comp in the Layer Comps panel and click the Delete icon  in the panel, or choose Delete Layer Comp from the panel menu.
 - Drag it to the Delete icon in the panel.

Export layer comps

You can export layer comps to individual files.

- ❖ Choose File > Scripts > Layer Comps to Files and then choose the file type and set the destination.

Note: Note, you can also export to a Web Photo Gallery (WPG), but you must have the optional Web Photo Gallery plug-in installed on your computer. You can find the plug-in on in the Goodies folder on your installation disc.

Masking layers

You can add a mask to a layer and use the mask to hide portions of the layer and reveal the layers below. Masking layers is a valuable compositing technique for combining multiple photos into a single image or for making local color and tonal corrections.

For a video on using layer masks, see www.adobe.com/go/lrvid0003_ps.

About layer and vector masks

You can use masks to hide portions of a layer and reveal portions of the layers below. You can create two types of masks:

- Layer masks are resolution-dependent bitmap images that are edited with the painting or selection tools.
- Vector masks are resolution independent and are created with a pen or shape tool.

Layer and vector masks are nondestructive, which means you can go back and re-edit the masks later without losing the pixels they hide.

In the Layers panel, both the layer and vector masks appear as an additional thumbnail to the right of the layer thumbnail. For the layer mask, this thumbnail represents the grayscale channel that is created when you add the layer mask. The vector mask thumbnail represents a path that clips out the contents of the layer.

Note: To create a layer or vector mask on the Background layer, first convert it to a regular layer (Layer > New > Layer from Background).

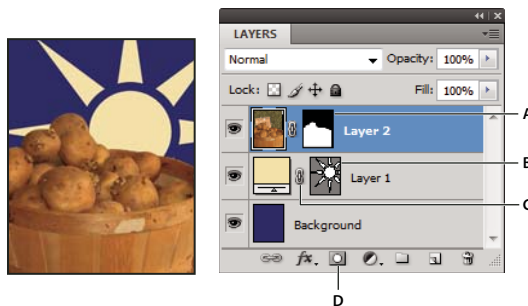

Masking layer

A. Layer mask thumbnail B. Vector mask thumbnail C. Vector Mask Link icon D. Add Mask

You can edit a layer mask to add or subtract from the masked region. A layer mask is a grayscale image, so areas you paint in black are hidden, areas you paint in white are visible, and areas you paint in shades of gray appear in various levels of transparency.

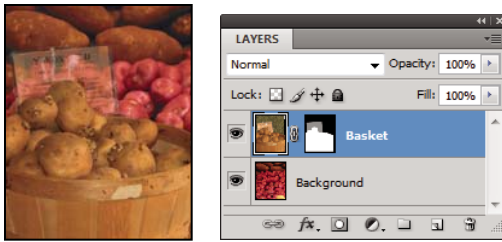

Background painted with black; description card painted with gray; basket painted with white

A vector mask creates a sharp-edged shape on a layer and is useful anytime you want to add a design element with clean, defined edges. After you create a layer with a vector mask, you can apply one or more layer styles to it, edit them if needed, and instantly have a usable button, panel, or other web-design element.

The Masks panel provides additional controls to adjust a mask. You can change the opacity of mask to let more or less of the masked content show through, invert the mask, or refine the mask borders, as with a selection area.

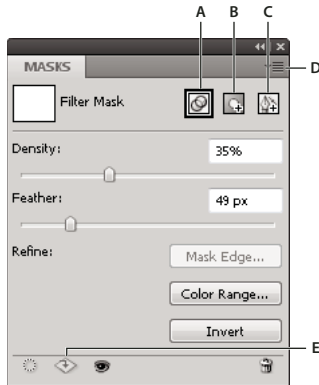



Masks panel

A. Select the filter mask. B. Add a pixel mask. C. Add a vector mask. D. Panel menu. E. Apply Mask

Add layer masks

When you add a layer mask, you need to decide if you want to hide or show all of the layer. Later, you'll paint on the mask to hide portions of that layer and reveal the layers beneath. Or, you can create a layer mask that automatically hides a portion of the layer by making a selection before creating the mask.



Add a mask that shows or hides the entire layer

- 1 Make sure that no part of your image is selected. Choose **Select > Deselect**.
- 2 In the Layers panel, select the layer or group.
- 3 Do one of the following:
 - To create a mask that reveals the entire layer, click the Pixel Mask  button in the Masks panel, or click the Add Layer Mask  button in the Layers panel, or choose **Layer > Layer Mask > Reveal All**.
 - To create a mask that hides the entire layer, Alt-click (Windows) or Option-click (Mac OS) the Pixel Mask  button in the Masks panel, or Alt-click (Windows) or Option-click (Mac OS) the Add Layer Mask button, or choose **Layer > Layer Mask > Hide All**.

Add a layer mask that hides part of a layer

- 1 In the Layers panel, select the layer or group.

2 Select the area in the image, and do one of the following:

- Click the Pixel Mask  button in the Masks panel, or the New Layer Mask button  in the Layers panel to create a mask that reveals the selection.
- Alt-click (Windows) or Option-click (Mac OS) the Pixel Mask button in the Masks panel, or the Add Layer Mask button in the Layers panel, to create a mask that hides the selection.
- Choose Layer > Layer Mask > Reveal Selection or Hide Selection.

Apply a layer mask from another layer

❖ Do one of the following:

- To move the mask to another layer, drag the mask to the other layer.
- To duplicate the mask, Alt-drag (Windows) or Option-drag (Mac OS) the mask to other layer.

Edit a layer mask

1 In the Layers panel, select the layer containing the mask you want to edit.

2 Click the Pixel Mask button in the Masks panel to make it active. A border appears around the mask thumbnail.

3 Select any of the editing or painting tools.

Note: The foreground and background colors assume default grayscale values when the mask is active.

4 Do one of the following:

- To subtract from the mask and reveal the layer, paint the mask with white.
- To make the layer partially visible, paint the mask with gray. Darker grays make the level more transparent, lighter grays make it more opaque.
- To add to the mask and hide the layer or group, paint the mask with black. The layers below become visible.

To edit the layer instead of the layer mask, select it by clicking its thumbnail in the Layers panel. A border appears around the layer thumbnail.

 *To paste a copied selection into a layer mask, Alt-click (Windows) or Option-click (Mac OS) the layer mask thumbnail in the Layers panel to select and display the mask channel. Choose Edit > Paste, then Select > Deselect. The selection is converted to grayscale and added to the mask. Click the layer thumbnail in the Layers panel to deselect the mask channel.*

Change mask opacity or refine edges

Use the Masks panel to adjust the opacity of a selected layer mask or vector mask. The Density slider controls mask opacity. Feathering lets you soften the edges of a mask. The Invert option lets you reverse masked and unmasked areas.

The Mask Edge option gives you a variety of controls to modify the mask edges, such as Smooth and Contract/Expand. For information on the Color Range option see “Create an adjustment layer mask using a color range” on page 322.

For information on modifying vector masks, see “Change vector mask opacity or feather mask edges” on page 324.

For a video on using layer masks, see www.adobe.com/go/lrvid4003_ps.

Change mask density

1 In the Layers panel, select the layer containing the mask you want to edit.

2 Click the Pixel Mask button in the Masks panel to make it active.

- 3 In the Masks panel, drag the Density slider to adjust the mask opacity.

At 100% density, the mask is completely opaque and blocks out any underlying area of the layer. As you lower the density, more of the area under the mask becomes visible.

Feather mask edges

- 1 In the Layers panel, select the layer containing the mask you want to edit.
- 2 Click the Pixel Mask button in the Masks panel to make it active.
- 3 In the Masks panel, drag the Feather slider to apply feathering to the mask edges.

Feathering blurs the edges of the mask to create a softer transition between the masked and unmasked areas. Feathering is applied from the edges of the mask outward, within the range of pixels you set with the slider.

Refine mask edges

- 1 In the Layers panel, select the layer containing the mask you want to edit.
- 2 Click the Pixel Mask button in the Masks panel to make it active.
- 3 Click Mask Edge. You can modify mask edges with the options in the Refine Mask dialog box, and view the mask against different backgrounds. For a description of options see “[Refine selection edges](#)” on page 258.
- 4 Click OK to close the Refine Mask dialog box and apply your changes to the layer mask.

Create an adjustment layer mask using a color range

The Color Range feature, which is useful for creating a selection area based on sampled colors in an image, can also be used to create a mask. For more information, see “[Select a color range](#)” on page 253.

- 1 In the Layers panel, select the layer to which you want to apply the adjustment layer.
- 2 Choose Window > Adjustments to display the Adjustments panel.
- 3 Click an adjustment in the Adjustments panel to add an adjustment layer to the image. A layer mask is automatically added as part of the adjustment layer.
- 4 In the Masks panel, click Color Range.
- 5 In the Color Range dialog box, choose Sampled Colors from the Select menu.
- 6 Select Localized Color Clusters to build a mask based on different color ranges in the image.
- 7 Set the display option to Selection, and Selection Preview to None.
- 8 Click on a color area in the image.

 *To sample multiple areas, hold down Shift to activate the plus eyedropper. Hold down Alt (Windows) or Option (Mac OS) to activate the minus eyedropper.*

As you click on image areas, you can preview the mask in the Color Range dialog box. White areas are unmasked pixels, black areas masked, and gray areas partially masked.

- 9 Use the Fuzziness slider to increase or decrease the range of colors around your sample colors that are included in the masked area. Use the Range slider to control how far or near a color must be from the sample points to be included in the mask. After adjusting the mask, click OK to close the Color Range dialog box.
- 10 In the Adjustments panel, modify the adjustment as needed.

The adjustment is only applied to the unmasked (or partially masked) areas of the image. If necessary click Color Range again to make further adjustments to the adjustment layer mask.

Select and display the layer mask channel

For easier editing of a layer mask, you can display the grayscale mask by itself or as a ruyolith overlay on the layer.

- ❖ Do one of the following:
 - Alt-click (Windows) or Option-click (Mac OS) the layer mask thumbnail to view only the grayscale mask. To redisplay the layers, Alt-click or Option-click the layer mask thumbnail, or click an eye icon .
 - Hold down Alt+Shift (Windows) or Option+Shift (Mac OS), and click the layer mask thumbnail to view the mask on top of the layer in a ruyolith masking color. Hold down Alt+Shift or Option+Shift, and click the thumbnail again to turn off the color display.

Disable or enable a layer mask

- ❖ Do one of the following:
 - Select the layer containing the layer mask you want to disable or enable, and click the Disable/Enable Mask button  in the Masks panel.
 - Shift-click the layer mask thumbnail in the Layers panel.
 - Select the layer containing the layer mask you want to disable or enable, and choose Layer > Layer Mask > Disable or Layer > Layer Mask > Enable.

A red X appears over the mask thumbnail in the Layers panel when the mask is disabled, and the layer's content appears without masking effects.

Change the layer mask ruyolith color or opacity

- 1 Do one of the following:
 - Alt-click (Windows) or Option-click (Mac OS) the layer mask thumbnail to select the layer mask channel; then double-click the layer mask thumbnail.
 - Double-click the layer mask channel in the Channels panel.
- 2 To choose a new mask color, in the Layer Mask Display Options dialog box, click the color swatch and choose a new color.
- 3 To change the opacity, enter a value between 0% and 100%.

Both the color and opacity settings affect only the appearance of the mask and have no effect on how underlying areas are protected. For example, you may want to change these settings to make the mask more easily visible against the colors in the image.

- 4 Click OK.

Add and edit vector masks

You create vector masks with the pen or shapes tools. For more information on working with these tools, see [“Drawing”](#) on page 359.

Add a vector mask that shows or hides the entire layer

- 1 In the Layers panel, select the layer you want to add the vector mask to.
- 2 Do one of the following:
 - To create a vector mask that reveals the entire layer, click the Vector Mask button in the Masks panel, or choose Layer > Vector Mask > Reveal All.

- To create a vector mask that hides the entire layer, Alt-click (Windows) or Option-click (Mac OS) the Vector Mask button in the Masks panel, or choose Layer > Vector Mask > Hide All.

Add a vector mask that shows the contents of a shape

- 1 In the Layers panel, select the layer to which to add a vector mask.
- 2 Select a path, or use one of the shape or Pen tools to draw a work path.

Note: To create a path with a Shape tool, click the Paths icon in the Shape tool options bar.

- 3 Click the Vector Mask button in the Masks panel, or choose Layer > Vector Mask > Current Path.

Edit a vector mask

- 1 In the Layers panel, select the layer containing the vector mask you want to edit.
- 2 Click the Vector Mask button in the Masks panel or the thumbnail in the Paths panel. Then change the shape using the shape, pen, or Direct Selection tools. See “Editing paths” on page 372.

Change vector mask opacity or feather mask edges

- 1 In the Layers panel, select the layer containing the vector mask.
- 2 Click the Vector Mask button in the Masks panel.
- 3 In the Masks panel, drag the Density slider to adjust the mask opacity, and the Feathering slider to apply feathering to the mask edges. See “Change mask opacity or refine edges” on page 321.

Remove a vector mask

- 1 In the Layers panel, select the layer containing the vector mask.
- 2 Click the Vector Mask button in the Masks panel.
- 3 In the Masks panel, click the Delete Mask button .

Disable or enable a vector mask

- ❖ Do one of the following:
 - Select the layer containing the vector mask you want to disable or enable, and click the Disable/Enable Mask button  in the Masks panel.
 - Shift-click the vector mask thumbnail in the Layers panel.
 - Select the layer containing the vector mask you want to disable or enable, and choose Layer > Vector Mask > Disable or Layer > Vector Mask > Enable.



A red X appears over the mask thumbnail in the Layers panel when the mask is disabled, and the layer’s content appears without masking effects.

Convert a vector mask to a layer mask

- ❖ Select the layer containing the vector mask you want to convert, and choose Layer > Rasterize > Vector Mask.

Important: After you rasterize a vector mask, you can’t change it back into a vector object.

Unlinking layers and masks

By default, a layer or group is linked to its layer mask or vector mask, as indicated by the link icon  between the thumbnails in the Layers panel. The layer and its mask move together in the image when you move either one with the Move tool . Unlinking them lets you move them independently and shift the mask's boundaries separately from the layer.

- To unlink a layer from its mask, click the link icon in the Layers panel.
- To reestablish the link between a layer and its mask, click between the layer and mask path thumbnails in the Layers panel.

Apply or delete a layer mask

You can apply a layer mask to permanently delete the hidden portions of a layer. Layer masks are stored as alpha channels, so applying and deleting layer masks can help reduce file size. You can also delete a layer mask without applying the changes.

- 1 In the Layers panel, select the layer containing the layer mask.
- 2 In the Masks panel, click the Pixel Mask button.
- 3 Do one of the following:
 - To remove the layer mask after applying it permanently to the layer, click the Apply Mask icon  at the bottom of the Masks panel.
 - To remove the layer mask without applying it to the layer, click the Delete button at the bottom of the Masks panel, and then click Delete.

You can also apply or delete layer masks using the Layer menu.

Note: You cannot apply a layer mask permanently to a Smart Object layer when deleting the layer mask.

Load a layer or layer mask's boundaries as a selection

You can select all the non-transparent areas on a layer, or, if a layer mask exists, all the unmasked areas. This is useful when you want to select text or image content that is surrounded by or contains transparent areas, or to create a selection that excludes masked areas on a layer.

- 1 Do one of the following:
 - To select only the non-transparent areas on an unmasked layer, Ctrl-click (Windows) or Command-click (Mac OS) the layer thumbnail in the Layers panel.
 - To select the unmasked areas on a layer that has a layer mask, Ctrl-click (Windows) or Command-click (Mac OS) the layer mask thumbnail in the Layers panel.
- 2 If a selection already exists, you can do any of the following:
 - To add the pixels to an existing selection, press Ctrl+Shift (Windows) or Command+Shift (Mac OS), and click the layer thumbnail or layer mask thumbnail in the Layers panel.
 - To subtract the pixels from an existing selection, press Ctrl+Alt (Windows) or Command+Option (Mac OS), and click the layer thumbnail or layer mask thumbnail in the Layers panel.
 - To load the intersection of the pixels and an existing selection, press Ctrl+Alt+Shift (Windows) or Command+Option+Shift (Mac OS), and click the layer thumbnail or layer mask thumbnail in the Layers panel.

 If you want to move all the contents of a layer, use the Move tool without loading a transparency mask.

Mask layers with clipping masks

A *clipping mask* lets you use the content of a layer to mask the layers above it. The masking is determined by the content of the bottom or *base layer*. The non-transparent content of the base layer clips (reveals), the content of the layers above it in the clipping mask. All other content in the clipped layers is masked out.

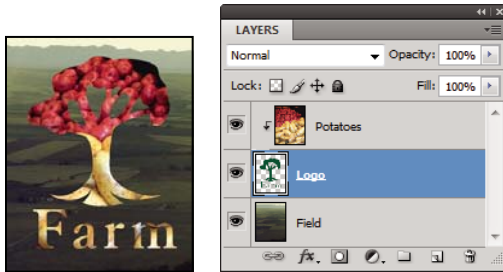

Clipping mask: content of the clipped layer (Potatoes) is only visible within the content of the base layer (Logo)

You can use multiple layers in a clipping mask, but they must be successive layers. The name of the base layer in the mask is underlined, and the thumbnails for the overlying layers are indented. The overlying layers display a clipping mask icon .

The Blend Clipped Layers As Group option in the Layer Style dialog box determines whether the blending mode of the base affects the whole group or just the base. (See “[Group blend effects](#)” on page 296.)

Create a clipping mask

- 1 Arrange the layers in the Layers panel so that the base layer with the mask is below the layers that you want to mask.
- 2 Do one of the following:
 - Hold down Alt (Windows) or Option (Mac OS), position the pointer over the line in the Layers panel dividing the base layer and the first layer above it that you want to include in the clipping mask (the pointer changes to two overlapping circles ) , and click.
 - Select the first layer above the base layer in the Layers panel, and choose Layer > Create Clipping Mask.
- 3 To add additional layers to the clipping mask, use either method in step 2, and work your way upward one level at a time in the Layers panel.

Note: If you create a new layer between layers in a clipping mask, or drag an unclipped layer between layers in a clipping mask, the layer becomes part of the clipping mask.

Layers in the clipping mask are assigned the opacity and mode attributes of the base layer.

Remove a layer from a clipping mask

- ❖ Do one of the following:
 - Hold down Alt (Windows) or Option (Mac OS), position the pointer over the line separating two grouped layers in the Layers panel (the pointer changes to two overlapping circles ) , and click.
 - In the Layers panel, select a layer in the clipping mask, and choose Layer > Release Clipping Mask. This command removes the selected layer and any layers above it from the clipping mask.

Release all layers in a clipping mask

- 1 In the Layers panel, select the clipping mask layer just above the base layer.
- 2 Choose Layer > Release Clipping Mask.

Combine multiple images into a group portrait

You can use the Auto-Align Layers command from the Edit menu to make a composite photo from a pair of nearly identical images that may contain some unwanted areas. For example, one shot of a group portrait is ideal except that one of the subjects has her eyes closed. In another shot her eyes are open. Using Auto-Align Layers and layer masking, you can combine these shots and eliminate the flaw in the final image.

For a video on aligning layers by content, see www.adobe.com/go/vid0014.

- 1 Open the two images you want to combine.
- 2 Create a new image (File > New) with the same dimensions as the two source images.
- 3 In the Layers panel for each source image, select the layer that contains the image content, and drag it to the new image window. The Layers panel for the new image now contains two new layers, one for each source image.
- 4 In the Layers panel of the new image, arrange the new layers so the layer that contains the content you want to correct (portrait with eyes closed) is on top of the layer that contains the correct content (portrait with eyes open).
- 5 Select the two new layers, and choose Edit > Auto-Align Layers.
- 6 Select Reposition Only, then click OK. Photoshop finds the common areas in each layer and aligns them so that identical areas overlap.
- 7 Click the top layer to select only that layer.
- 8 Add a blank layer mask to the layer:
 - Click Add Layer Mask in the Layers panel.
 - Choose Layer > Layer Mask > Reveal All.
- 9 Set the foreground color to black, choose a brush tip and size, and zoom in if necessary to focus on the part of the image you want to correct.
- 10 Using the brush tool, add to the layer mask by painting over the top layer. Painting with black completely masks out the top layer, while grayscale creates partial transparency to the layer below, and white restores the top layer. See “[Edit a layer mask](#)” on page 321. Continue editing the layer mask until you successfully blend the two layers to create one unified image.

Note: Make sure that the layer mask thumbnail, not the image thumbnail, is selected in the Layers panel during the masking operation.
- 11 To allow further editing, save the layered and masked version of the image, and make another copy that you can flatten to produce a single-layer version with a smaller file size.

See also

“[Merge and stamp layers](#)” on page 292

[Applying filters video](#)

Chapter 11: Painting

Painting changes the color of image pixels. You use painting tools and techniques to retouch images, create or edit masks on alpha channels, rotoscope or paint on video frames, and to paint original art. Brush tips, brush presets, and the many brush options give you creative control to produce stunning painting effects or to simulate working with traditional media. You can work with several painting tools on 32-bit per channel, high dynamic range (HDR) images including Paintbrush, Pencil, Smudge, Sharpen, Blur, Stamp, History Brush, Pattern Stamp, and Eraser.

Painting tools

About painting tools, options, and panels

Adobe Photoshop CS4 provides several tools for painting and editing image color. The Brush tool and the Pencil tool work like traditional drawing tools by applying color with brush strokes. The Gradient tool, Fill command, and Paint Bucket tool apply color to large areas. Tools like the Eraser tool, Blur tool, and Smudge tool modify the existing colors in the image. See [“Painting tools gallery”](#) on page 21.

In the options bar for each tool, you can set how color is applied to an image and choose from preset brush tips.

Brush and tool presets

You can save a set of brush options as a preset so you can quickly access brush characteristics you use frequently. Photoshop includes several sample brush presets. You can start with these presets and modify them to produce new effects. Many original brush presets are available for download on the web.

You choose presets from the Brush Preset picker, which stores preset brushes and allows you to temporarily modify the diameter and hardness of a brush preset.

You use tool presets when you want to save brush tip characteristics along with settings from the options bar, such as opacity, flow, and color. To learn more about tool presets, see [“Create and use tool presets”](#) on page 25.

Brush tip options

Along with settings in the options bar, brush tip options control how color is applied. You can apply color gradually, with soft edges, with large brush strokes, with various brush dynamics, with different blending properties, and with brushes of different shapes. You can apply a texture with your brush strokes to simulate painting on canvas or art papers. You can also simulate spraying paint with an airbrush. You use the Brushes panel to set brush tip options. See [“Brushes panel overview”](#) on page 335.

If you work with a drawing tablet, you can control how color is applied using pen pressure, angle, rotation, or a stylus wheel. You set options for drawing tablets in the Brushes panel.

 You can resize or change the hardness of painting cursors by dragging. Right-click + Alt (Windows) or Control + Option (Mac OS) and drag to the left or right to reduce or enlarge the size of the painting cursor. Shift + right-click + Alt (Windows) or Control + Option + Command (Mac OS) and drag to the left or right to change the hardness.



See also

[“Resize or change hardness of painting cursors by dragging”](#) on page 25

Paint with the Brush tool or Pencil tool

The Brush tool and the Pencil tool paint the current foreground color on an image. The Brush tool creates soft strokes of color. The Pencil tool creates hard-edged lines.

Note: The Rotation tool rotates the canvas, which can facilitate easier painting. See “[Use the Rotate View tool](#)” on page 27.

- 1 Choose a foreground color. (See “[Choose colors in the toolbox](#)” on page 114.)
- 2 Select the Brush tool  or Pencil tool .
- 3 Choose a brush from the Brush Presets picker. See “[Select a preset brush](#)” on page 333.
- 4 Set tool options for mode, opacity, and so on, in the options bar. See “[Paint tool options](#)” on page 329.
- 5 Do one or more of the following:
 - Click and drag in the image to paint.
 - To draw a straight line, click a starting point in the image. Then hold down Shift, and click an ending point.
 - When using the Brush tool as an airbrush, hold down the mouse button without dragging to build up color.

See also

“[Resize or change hardness of painting cursors by dragging](#)” on page 25

Paint tool options

Set the following options for painting tools in the options bar. Options available vary with each tool.

Mode Sets the method for blending the color you paint with the underlying existing pixels. Available modes change with the currently selected tool. Paint modes are similar to layer blending modes. See “[List of blending modes](#)” on page 347.

Opacity Sets the transparency of color you apply. As you paint over an area, the opacity will not exceed the set level no matter how many times you move the pointer over the area, until you release the mouse button. If you stroke over the area again, you will apply additional color, equivalent to the set opacity. Opacity of 100 percent is opaque.

Flow Sets the rate at which color is applied as you move the pointer over an area. As you paint over an area, keeping the mouse button down, the amount of color will build up based on the flow rate, up to the opacity setting. For example, if you set the opacity to 33% and the flow to 33%, each time you move over an area, its color moves 33% towards the brush color. The total will not exceed 33% opacity unless you release the mouse button and stroke over the area again.

 *Press a number key (must be at the top of the keyboard; it will not work with the keypad) to set a tool's opacity in multiples of 10% (pressing 1 sets it to 10%; pressing 0 sets it to 100%). Use Shift and number key to set Flow.*

Airbrush  Simulates painting with an airbrush. As you move the pointer over an area, paint builds up as you hold down the mouse button. Brush hardness, opacity, and flow options control how fast and how much the paint is applied. Click the button to turn this option on or off.

Auto erase (Pencil tool only) Paints the background color over areas containing the foreground color. Select the foreground color you want to erase and the background color you want to change to. (See “[Auto Erase with the Pencil tool](#)” on page 333.)

Paint with a pattern

The Pattern Stamp tool paints with a pattern. You can select a pattern from the pattern libraries or create your own patterns.

- 1 Select the Pattern Stamp tool .
- 2 Choose a brush from the Brush Presets picker. See “[Select a preset brush](#)” on page 333.)
- 3 Set tool options for mode, opacity, etc. in the options bar. See “[Paint tool options](#)” on page 329.
- 4 Select Aligned in the options bar to maintain the pattern’s continuity with your original start point, even if you release the mouse button and then continue painting. Deselect Aligned to restart the pattern each time you stop and start painting.
- 5 Select a pattern from the Pattern pop-up panel in the options bar.
- 6 If you’d like to apply the pattern with an impressionistic effect, select Impressionist.
- 7 Drag in the image to paint it with the pattern.

See also

“[Creating and managing patterns](#)” on page 357

Paint with the Art History Brush

The Art History Brush tool paints with stylized strokes, using the source data from a specified history state or snapshot. By experimenting with different paint style, size, and tolerance options, you can simulate the texture of painting with different colors and artistic styles.

Like the History Brush tool, the Art History Brush tool uses a specified history state or snapshot as the source data. The History Brush tool, however, paints by recreating the specified source data, while the Art History Brush tool uses that data along with the options you set to create different colors and artistic styles.

 For a variety of visual effects, experiment with applying filters or filling an image with a solid color before painting with the Art History Brush tool. Also try increasing the size of the image by a factor of 4 to soften the details.

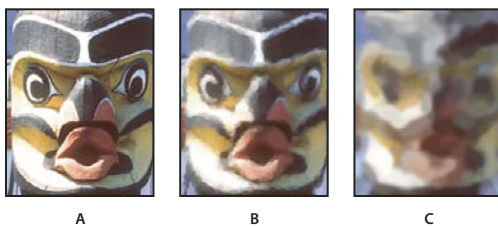

Example of using the Art History Brush tool
A. Original B. Using a small brush C. Using a large brush

- 1 In the History panel, click the left column of the state or snapshot to use as the source for the Art History Brush tool. A brush icon appears next to the source history state.
- 2 Select the Art History Brush tool .
- 3 Do the following in the options bar:
 - Choose a brush from the Brush Presets picker, and set brush options. (See “[Select a preset brush](#)” on page 333.)
 - Choose a blending mode from the Mode menu. (See “[About blending modes](#)” on page 346.)
 - Choose an option from the Style menu to control the shape of the paint stroke.

- For Area, enter a value to specify the area covered by the paint strokes. The greater the size, the larger the covered area and the more numerous the strokes.
 - For Tolerance, enter a value to limit the regions where paint strokes can be applied. A low tolerance lets you paint unlimited strokes anywhere in the image. A high tolerance limits paint strokes to areas that differ considerably from the color in the source state or snapshot.
- 4 Click and drag in the image to paint.

Erase with the Eraser tool

The Eraser tool changes pixels to either the background color or to transparent. If you're working on a background or in a layer with transparency locked, the pixels change to the background color; otherwise, the pixels are erased to transparency.

You can also use the eraser to return the affected area to a state selected in the History panel.

- 1 Select the Eraser tool .
- 2 Set the background color you want to apply if you are erasing in the background or a layer with locked transparency.
- 3 Choose a mode for the eraser. Brush and Pencil set the eraser to act like those tools. Block is a hard-edged, fixed-sized square with no options for changing the opacity or flow.
- 4 For Brush and Pencil modes, choose a brush preset, and set Opacity and Flow in the options bar.

An opacity of 100% erases pixels completely. A lower opacity erases pixels partially. See “[Paint tool options](#)” on page 329.

- 5 To erase to a saved state or snapshot of the image, click the left column of the state or snapshot in the History panel, and then select Erase To History in the options bar.

 (Photoshop) To temporarily use the Eraser tool in Erase to History mode, hold down *Alt* (Windows) or *Option* (Mac OS) as you drag in the image.

- 6 Drag through the area you want to erase.

Change similar pixels with the Magic Eraser tool

When you click in a layer with the Magic Eraser tool, the tool changes all similar pixels to transparent. If you're working in a layer with locked transparency, the pixels change to the background color. If you click in the background, it is converted to a layer and all similar pixels change to transparent.

You can choose to erase contiguous pixels only or all similar pixels on the current layer.

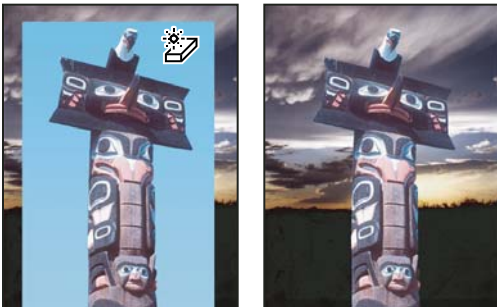

Example of erasing similar pixels

- 1 Select the Magic Eraser tool .

- 2 Do the following in the options bar:
 - Enter a tolerance value to define the range of colors that can be erased. A low tolerance erases pixels within a range of color values very similar to the pixel you click. A high tolerance extends the range of colors that will be erased.
 - Select Anti-aliased to smooth the edges of the area you erase.
 - Select Contiguous to erase only pixels contiguous to the one you click, or deselect to erase all similar pixels in the image.
 - Select Sample All Layers to sample the erased color using combined data from all visible layers.
 - Specify an opacity to define the strength of the erasure. An opacity of 100% erases pixels completely. A lower opacity erases pixels partially.
- 3 Click in the part of the layer you want to erase.

Change pixels to transparent with the Background Eraser tool

The Background Eraser tool erases pixels on a layer to transparency as you drag; this allows you to erase the background while maintaining the edges of an object in the foreground. By specifying different sampling and tolerance options, you can control the range of the transparency and the sharpness of the boundaries.

 *If you want to erase the background of an object with intricate or wispy edges, use QuickSelect.*

The background eraser samples the color in the center of the brush, also called the hot spot, and deletes that color wherever it appears inside the brush. It also performs color extraction at the edges of any foreground objects, so that color halos are not visible if the foreground object is later pasted into another image.

Note: *The background eraser overrides the lock transparency setting of a layer.*

- 1 In the Layers panel, select the layer containing the areas you want to erase.
- 2 Select the Background Eraser tool .
- 3 Click the brush sample in the options bar, and set brush options in the pop-up panel:
 - Choose settings for the Diameter, Hardness, Spacing, Angle, and Roundness options (see “[Brush tip shape options](#)” on page 337).
 - If you’re using a pressure-sensitive digitizing tablet, choose options from the Size and Tolerance menus to vary the size and tolerance of the background eraser over the course of a stroke. Choose Pen Pressure to base the variation on the pen pressure. Choose Stylus Wheel to base the variation on the position of the pen thumbwheel. Choose Off if you don’t want to vary the size or tolerance.
- 4 Do the following in the options bar:
 - Choose a Limits mode for erasing: Discontiguous to erase the sampled color wherever it occurs under the brush; Contiguous to erase areas that contain the sampled color and are connected to one another; and Find Edges to erase connected areas containing the sampled color while better preserving the sharpness of shape edges.
 - For Tolerance, enter a value or drag the slider. A low tolerance limits erasure to areas that are very similar to the sampled color. A high tolerance erases a broader range of colors.
 - Select Protect Foreground Color to prevent the erasure of areas that match the foreground color in the toolbox.
 - Choose a Sampling option: Continuous to sample colors continuously as you drag; Once to erase only areas containing the color you first click; and Background Swatch to erase only areas containing the current background color.

- 5 Drag through the area you want to erase. The Background Eraser tool pointer appears as a brush shape with a cross hair indicating the tool's hot spot .

Auto Erase with the Pencil tool

The Auto Erase option for the Pencil tool lets you paint the background color over areas containing the foreground color.

- 1 Specify foreground and background colors.
- 2 Select the Pencil tool .
- 3 Select Auto Erase in the options bar.
- 4 Drag over the image.

If the center of the cursor is over the foreground color when you begin dragging, the area is erased to the background color. If the center of the cursor is over an area that doesn't contain the foreground color when you begin dragging, the area is painted with the foreground color.

Changing the brush cursor

The painting tools have three possible cursors: the standard cursor (the icon from the toolbox), a cross hair , and a cursor that matches the size and shape of the currently selected brush tip. You change the brush tip cursor in the Cursors preferences dialog box.

- 1 Choose Edit > Preferences > Cursors (Windows) or Photoshop > Preferences > Cursors (Mac OS).
- 2 Select the desired cursors in both the Painting Cursors area and the Other Cursors area. The sample cursors change to reflect your choices. For a Brush Tip cursor, choose a size and whether to include a cross hair in the cursor.
 - Normal Brush Tip restricts the cursor size to areas of the brush stroke that have 50% or more opacity.
 - Full Size Brush Tip sizes the cursor to the entire area affected by the brush stroke. For soft brushes, this produces a larger cursor size than the Normal setting, to include the areas of the brush stroke with lighter opacity.
- 3 Click OK.

 *For the Pen and Brush tools, the Caps Lock key or the Shift+Caps Lock keys act like a toggle for changing between the standard cursor and the cross hair.*

Brush presets

A preset brush is a saved brush tip with defined characteristics, such as size, shape, and hardness. You can save preset brushes with the characteristics you use often. You can also save tool presets for the Brush tool that you can select from the Tool Preset menu in the options bar.

When you change the size, shape, or hardness of a preset brush, the change is temporary. The next time you choose that preset, the brush uses its original settings. To make your changes permanent, you need to create a new preset. See [“Create a new preset brush”](#) on page 335.

Select a preset brush

- 1 Select a painting or editing tool, and click the Brush pop-up menu in the options bar.
- 2 Select a brush.

Note: You can also select a brush from the Brushes panel. To view the loaded presets, select Brush Presets on the left side of the panel.

3 Change options for the preset brush.

Diameter Temporarily changes the brush size. Drag the slider or enter a value. If the brush has a dual tip, both the primary and dual brush tips are scaled.

Use Sample Size Uses the original diameter of the brush tip if the brush tip shape is based on a sample. (Not available for round brushes.)

Hardness Temporarily changes the amount of anti-aliasing for the brush tool. At 100%, the brush tool paints with the hardest brush tip, but is still anti-aliased. The Pencil always paints a hard edge that is not anti-aliased.

See also

[“Brushes panel overview”](#) on page 335

[“Create and use tool presets”](#) on page 25

Change how preset brushes are displayed

Choose a display option from the brush preset picker menu  or Brushes panel menu:

- Text Only to view the brushes as a list.
- Small or Large Thumbnail to view the brushes as thumbnails.
- Small or Large List to view the brushes as a list with thumbnails.
- Stroke Thumbnail to view a sample brush stroke with each brush thumbnail.

 *To dynamically preview brush strokes in the Brushes panel, make sure that Brush Preset is selected, and then position the pointer over a brush until the tool tip appears. Move the pointer over different brushes. The preview area at the bottom of the panel will display sample brush strokes.*

Load, save, and manage brush presets

You can manage libraries of preset brushes to keep your brushes organized and to make available only the brushes you need for a project.

Change the preset brushes displayed in the panel

- 1 To load a library of preset brushes, choose one of the following from the Brush Preset picker menu or Brushes panel menu:
 - Load Brushes to add a library to the current list. Select the library file you want to use, and click Load.
 - Replace Brushes to replace the current list with a different library. Select the library file you want to use, and click Load.
 - A library file (displayed at the bottom of the panel menu). Click OK to replace the current list, or click Append to append the current list.
- 2 To return to the default library of preset brushes, choose Reset Brushes from the Brush Preset picker menu or Brushes panel menu. You can either replace the current list or append the default library to the current list.

Note: You can also use the Preset Manager to load and reset brush libraries.

Save a set of preset brushes as a library

- 1 Choose Save Brushes from the Brush Preset picker menu or Brushes panel menu.

2 Choose a location for the brush library, enter a file name, and click Save.

You can save the library anywhere. However, if you place the library file in the Presets/Brushes folder in the default preset location, the library name will appear at the bottom of the Brush Preset picker menu and Brushes panel menu after you restart Photoshop.

You can also use the Preset Manager to rename, delete, and save libraries of preset brushes. For more information, see “[Work with the Preset Manager](#)” on page 41.

Rename a preset brush

Do one of the following:

- Select a brush in the Brush Preset picker or Brushes panel, and choose Rename Brush from the panel menu. Enter a new name for the brush, and click OK.
- If the Brushes panel is set to display brushes as thumbnails, double-click a brush, enter a new name, and click OK.
- If the Brushes panel is set to display brushes as a list or text only, double-click a brush, enter a new name inline, and press Enter (Windows) or Return (Mac OS).

Delete a preset brush

- In the Brush Preset picker or Brushes panel, select a brush, and choose Delete Brush from the panel menu.
- In the Brush Preset picker or Brushes panel, Alt-click (Windows) or Option-click (Mac OS) the brush you want to delete.
- In the Brushes panel, select a brush and click the Delete icon , or drag a brush to the Delete icon.

Create a new preset brush

You can save a customized brush as a preset brush that appears in the Brushes panel, Brush Preset picker, and Preset Manager.

Note: *New preset brushes are saved in a Preferences file. If this file is deleted or damaged, or if you reset brushes to the default library, the new presets will be lost. To permanently save new preset brushes, save them in a library.*

- 1 Customize a brush.
- 2 Do one of the following in the Brushes panel or Brush Preset picker:
 - Choose New Brush Preset from the panel menu, enter a name for the preset brush, and click OK.
 - Click the Create New Brush button .

Creating and modifying brushes

You can create brushes that apply paint to images in a variety of ways. You select an existing preset brush, a brush tip shape, or create a unique brush tip from part of an image. You choose options from the Brushes panel to specify how the paint is applied.

Brushes panel overview

In the Brushes panel, you can select preset brushes, like in the Brush Preset Picker, but you can also modify existing brushes and design new custom brushes. The Brushes panel contains the brush tip options that determine how paint is applied to an image.

The brush stroke preview at the bottom of the panel shows how paint strokes look with the current brush options.

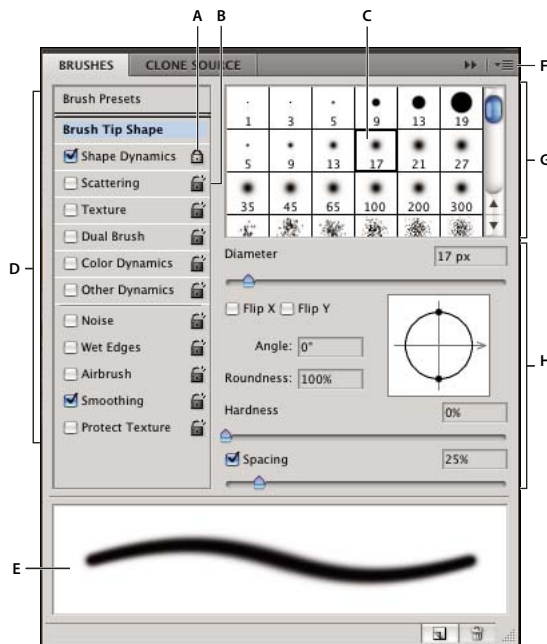

Brushes panel with Brush Tip Shape options displayed

A. Locked B. Unlocked C. Selected brush tip D. Brush settings E. Brush stroke preview F. pop-up menu G. Brush tip shapes (available when Brush Tip Shape option is selected) H. Brush options

Display the Brushes panel and brush options

- 1 Choose Window > Brushes. Or, select a painting, erasing, toning, or focus tool, and click the panel button  on the right side of the options bar.
- 2 Select an option set on the left side of the panel. The available options for the set appear on the right side of the panel.

 Click the check box to the left of the option set to enable or disable the options without viewing them.

Create a brush tip from an image

- 1 Use any selection tool to select a part of an image to use as a custom brush. Feather should be set to 0 pixels if you want to create a brush with a sharp edge. The brush shape can be up to 2500 pixels by 2500 pixels in size.



If you select color image, the brush tip image is converted to grayscale. Any layer mask applied to the image doesn't affect the definition of the brush tip.

 If you want to define a brush with soft edges, select pixels with gray values. (Colored brush shapes appear as gray values.)

- 2 Choose Edit > Define Brush Preset.
- 3 Name the brush, and click OK.

Create a brush and set painting options

- 1 Select a painting, erasing, toning, or focus tool. Then choose Window > Brushes.

- 2 In the Brushes panel, choose an existing brush preset to modify or select a brush shape from the Brush Tip Shape panel of the Brushes panel. You can also create a new brush tip from an image.
- 3 Select Brush Tip Shape on the left side of the Brushes panel, and set options. See “[Brush tip shape options](#)” on page 337.
- 4 To set other options for the brush, see the following topics:
 - “[Brush shape dynamics](#)” on page 340
 - “[Brush scattering](#)” on page 341
 - “[Textured brush options](#)” on page 342
 - “[Dual brushes](#)” on page 343
 - “[Color dynamics Brush options](#)” on page 343
 - “[Other dynamics brush options](#)” on page 344
 - “[Other Brush options](#)” on page 345
- 5 To lock brush tip shape attributes, click the unlock icon . To unlock the tip, click the lock icon .
- 6 To save the brush for use later, choose New Brush Preset from the Brushes panel menu.

Note: To save your new brush permanently or distribute it to other users, you must save the brush as part of a set of brushes. Choose Save Brushes from the Brushes panel menu, and then save to a new set or overwrite an existing set. If you reset or replace the brushes in the Brushes panel without saving it in a set, you could lose your new brush.

See also

“[Brushes panel overview](#)” on page 335

“[Create a brush tip from an image](#)” on page 336

Brush tip shape options

You can set the following brush tip shape options in the Brushes panel:

Diameter Controls the size of the brush. Enter a value in pixels or drag the slider.

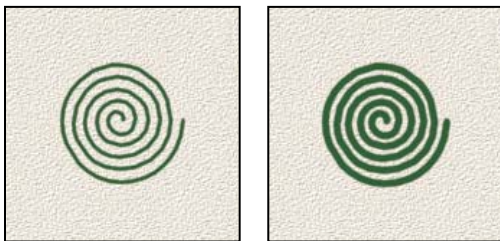

Brush strokes with different diameter values

Use Sample Size Resets the brush to its original diameter. This option is available only if the brush tip shape was created by sampling pixels in an image.

Flip X Changes the direction of a brush tip on its x axis.

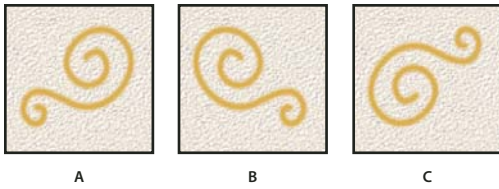

Flipping a brush tip on its x axis.
A. Brush tip in its default position **B.** Flip X selected **C.** Flip X and Flip Y selected

Flip Y Changes the direction of a brush tip on its y axis.

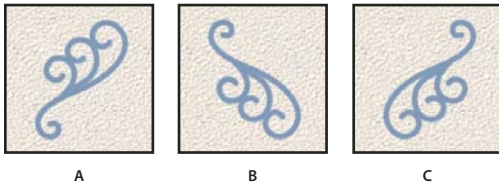

Flipping a brush tip on its y axis.
A. Brush tip in its default position **B.** Flip Y selected **C.** Flip Y and Flip X selected

Angle Specifies the angle by which an elliptical or sampled brush’s long axis is rotated from horizontal. Type a value in degrees, or drag the horizontal axis in the preview box.

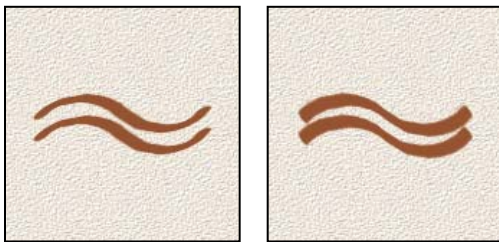

Angled brushes create a chiseled stroke

Roundness Specifies the ratio between the brush’s short and long axes. Enter a percentage value, or drag the points in the preview box. A value of 100% indicates a circular brush, a value of 0% indicates a linear brush, and intermediate values indicate elliptical brushes.

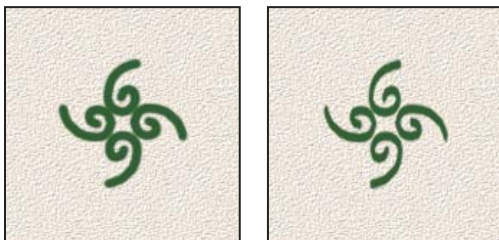

Adjusting roundness to compress a brush tip shape

Hardness Controls the size of the brush’s hard center. Type a number, or use the slider to enter a value that is a percentage of the brush diameter. You can’t change the hardness of sampled brushes.

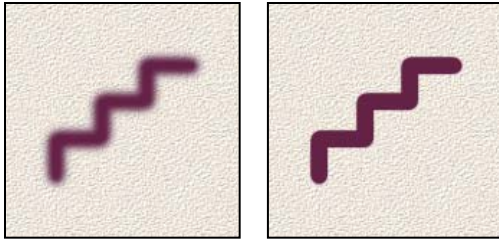

Brush strokes with different hardness values

Spacing Controls the distance between the brush marks in a stroke. To change the spacing, type a number, or use the slider to enter a value that is a percentage of the brush diameter. When this option is deselected, the speed of the cursor determines the spacing.

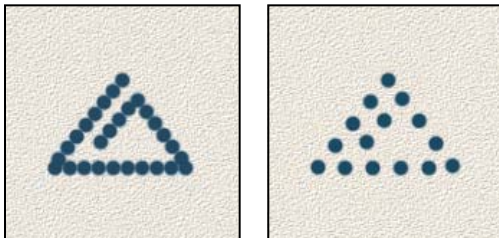

Increasing the spacing makes the brush skip

 While using a preset brush, press the [key to decrease the brush width; press the] key to increase the width. For hard round, soft round, and calligraphic brushes, press Shift+[to decrease the brush hardness; press Shift+] to increase the brush hardness.

See also

- “[Brushes panel overview](#)” on page 335
- “[Create a brush and set painting options](#)” on page 336

Adding brush dynamics

The Brushes panel provides many options for adding dynamic (or changing) elements to preset brush tips. For example, you can set options that vary the size, color, and opacity of brush marks over the course of a stroke.

You work with two components when adding dynamics elements to a brush:

- Jitter percentages specify the randomness of dynamic elements. At 0%, an element does not change over the course of a stroke; at 100%, an element has the maximum amount of randomness.
- Options in the Control pop-up menus specify how you want to control the variance of dynamic elements. You can choose not to control the variance of an element, to fade an element over the specified number of steps, or to vary an element based on pen pressure, pen tilt, position of the pen thumbwheel, or pen rotation.

Note: Pen controls are available only when you’re using a pressure-sensitive digitizing tablet such as the Wacom tablet, and supported pens (for rotation control and thumbwheel). A warning icon appears if you select a pen control but have not installed a tablet or are using a pen that is missing the control feature.

See also

[“Brushes panel overview”](#) on page 335

[“Create a brush and set painting options”](#) on page 336

Brush shape dynamics

Shape dynamics determine the variance of brush marks in a stroke.

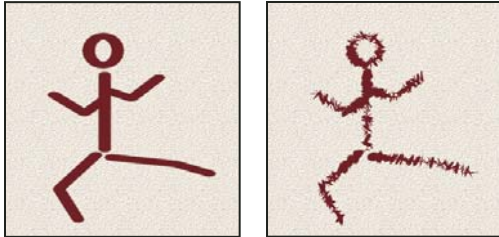

Brush strokes without shape dynamics and with shape dynamics

Size Jitter and Control Specifies how the size of brush marks vary in a stroke. For more information, see [“Adding brush dynamics”](#) on page 339.

To specify the maximum percentage of jittering, type a number or use the slider to enter a value. To specify how you want to control the size variance of brush marks, choose an option from the Control pop-up menu:

- **Off** Specifies no control over the size variance of brush marks.
- **Fade** Fades the size of brush marks between the initial diameter and the minimum diameter in the specified number of steps. Each step is equal to one mark of the brush tip. The value can range from 1 to 9999. For example, entering 10 steps produces a fade in 10 increments.
- **Pen Pressure, Pen Tilt, Stylus Wheel** Varies the size of brush marks between the initial diameter and the minimum diameter based on the pen pressure, pen tilt, or position of the pen thumbwheel.

Minimum Diameter Specifies the minimum percentage by which brush marks can scale when Size Jitter or Size Control is enabled. Type a number, or use the slider to enter a value that is a percentage of the brush tip diameter.

Tilt Scale Specifies the scale factor applied to the height of the brush prior to rotation when Size Control is set to Pen Tilt. Type a number, or use the slider to enter a value that is a percentage of the brush diameter.

Angle Jitter and Control Specifies how the angle of brush marks varies in a stroke. To specify the maximum percentage of jittering, enter a value that is a percentage of 360 degrees. To specify how you want to control the angle variance of brush marks, choose an option from the Control pop-up menu:

- **Off** Specifies no control over the angle variance of brush marks.
- **Fade** Fades the angle of brush marks between 0 and 360 degrees in the specified number of steps.
- **Pen Pressure, Pen Tilt, Stylus Wheel, Rotation** Varies the angle of brush marks between 0 and 360 degrees based on the pen pressure, pen tilt, position of the pen thumbwheel, or rotation of the pen.
- **Initial Direction** Bases the angle of brush marks on the initial direction of the brush stroke.
- **Direction** Bases the angle of brush marks on the direction of the brush stroke.

Roundness Jitter and Control Specifies how the roundness of brush marks varies in a stroke. To specify the maximum percentage of jittering, enter a percentage indicating the ratio between the brush's short and long axes. To specify how you want to control the roundness variance of brush marks, choose an option from the Control pop-up menu:

- **Off** Specifies no control over the roundness variance of brush marks.
- **Fade** Fades the roundness of brush marks between 100% and the Minimum Roundness value in the specified number of steps.
- **Pen Pressure, Pen Tilt, Stylus Wheel, Rotation** Varies the roundness of brush marks between 100% and the Minimum Roundness value based on the pen pressure, pen tilt, position of the pen thumbwheel, or rotation of the pen.

Minimum Roundness Specifies the minimum roundness for brush marks when Roundness Jitter or Roundness Control is enabled. Enter a percentage indicating the ratio between the brush's short and long axes.

See also

[“Adding brush dynamics”](#) on page 339

[“Create a brush and set painting options”](#) on page 336

Brush scattering

Brush scattering determines the number and placement of marks in a stroke.

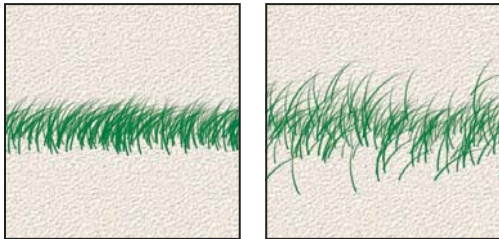

Brush strokes without scattering (left) and with scattering (right)

Scatter and Control Specifies how brush marks are distributed in a stroke. When Both Axes is selected, brush marks are distributed in a radial direction. When Both Axes is deselected, brush marks are distributed perpendicular to the stroke path.

To specify the maximum percentage of scattering, enter a value. To specify how you want to control the scattering variance of brush marks, choose an option from the Control pop-up menu:

- **Off** Specifies no control over the scattering variance of brush marks.
- **Fade** Fades the scattering of brush marks from maximum scattering to no scattering in the specified number of steps.
- **Pen Pressure, Pen Tilt, Stylus Wheel, Rotation** Varies the scattering of brush marks based on the pen pressure, pen tilt, position of the pen thumbwheel, or rotation of the pen.

Count Specifies the number of brush marks applied at each spacing interval.

Note: If you increase the count without increasing the spacing or scattering values, painting performance may decrease.

Count Jitter and Control Specifies how the number of brush marks varies for each spacing interval. To specify the maximum percentage of brush marks applied at each spacing interval, enter a value. To specify how you want to control the count variance of brush marks, choose an option from the Control pop-up menu:

- **Off** Specifies no control over the count variance of brush marks.

- **Fade** Fades the number of brush marks from the Count value to 1 in the specified number of steps.
- **Pen Pressure, Pen Tilt, Stylus Wheel, Rotation** Varies the number of brush marks based on the pen pressure, pen tilt, position of the pen thumbwheel, or rotation of the pen.

See also

[“Adding brush dynamics”](#) on page 339

[“Create a brush and set painting options”](#) on page 336

Textured brush options

A textured brush uses a pattern to make strokes look as if they are painted on textured canvas.

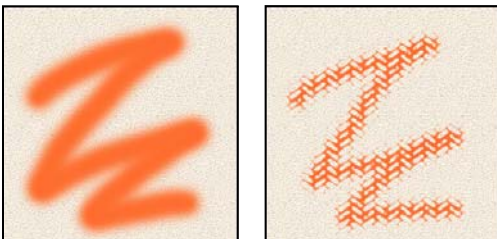

Brush strokes without texture (left) and with texture (right)

Click the pattern sample, and select a pattern from the pop-up panel. Set one or more of the following options:

Invert Inverts the high and low points in the texture based on the tones in the pattern. When Invert is selected, the lightest areas in the pattern are the low points in the texture and therefore receive the least paint; the darkest areas in the pattern are the high points in the texture and therefore receive the most paint. When Invert is deselected, the lightest areas in the pattern receive the most paint; the darkest areas in the pattern receive the least paint.

Scale Specifies the scale of the pattern. Type a number, or use the slider to enter a value that is a percentage of the pattern size.

Texture Each Tip Applies the selected texture individually to each brush mark in a brush stroke, rather than to the brush stroke as a whole (a brush stroke is made up of many brush marks, applied continuously as you drag the brush). You must select this option to make the Depth variance options available.

Mode Specifies the blending mode used to combine the brush and the pattern. (See [“About blending modes”](#) on page 346.)

Depth Specifies how deeply the paint penetrates into the texture. Type a number, or use the slider to enter a value. At 100%, the low points in the texture do not receive any paint. At 0%, all points in the texture receive the same amount of paint, therefore hiding the pattern.

Minimum Depth Specifies the minimum depth to which paint can penetrate when Depth Control is set to Fade, Pen Pressure, Pen Tilt, or Stylus Wheel, and Texture Each Tip is selected.

Depth Jitter and Control Specifies how the depth varies when Texture Each Tip is selected. To specify the maximum percentage of jitter, enter a value. To specify how you want to control the depth variance of brush marks, choose an option from the Control pop-up menu:

- **Off** Specifies no control over the depth variance of brush marks.
- **Fade** Fades from the Depth Jitter percentage to the Minimum Depth percentage in the specified number of steps.

- **Pen Pressure, Pen Tilt, Stylus Wheel, Rotation** Varies the depth based on the pen pressure, pen tilt, position of the pen thumbwheel, or rotation of the pen.

See also

“[Adding brush dynamics](#)” on page 339

“[Create a brush and set painting options](#)” on page 336

Dual brushes

A dual brush combines two tips to create brush marks. The second brush texture is applied within the brush stroke of the primary brush; only the areas where both brushstrokes intersect are painted. Set options for the primary tip in the Brush Tip Shape section of the Brushes panel. Select a second brush tip from the Dual Brush section of the Brushes panel, and set any of the following options.



A. Primary brush tip stroke (hard round 55). B. Secondary brush tip stroke (grass). C. Dual brush stroke (using both).

Mode Sets a blending mode to use when combining brush marks from the primary tip and the dual tip. (See “[List of blending modes](#)” on page 347.)

Diameter Controls the size of the dual tip. Enter a value in pixels, drag the slider, or click Use Sample Size to use the original diameter of the brush tip. (The Use Sample Size option is available only if the brush tip shape was created by sampling pixels in an image.)

Spacing Controls the distance between the dual tip brush marks in a stroke. To change the spacing, type a number, or use the slider to enter a percentage of the tip diameter.

Scatter Specifies how dual tip brush marks are distributed in a stroke. When Both Axes is selected, dual tip brush marks are distributed in a radial direction. When Both Axes is deselected, dual tip brush marks are distributed perpendicular to the stroke path. To specify the maximum percentage of scattering, type a number or use the slider to enter a value.

Count Specifies the number of dual tip brush marks applied at each spacing interval. Type a number, or use the slider to enter a value.

Color dynamics Brush options

Color dynamics determine how the color of paint changes over the course of a stroke.

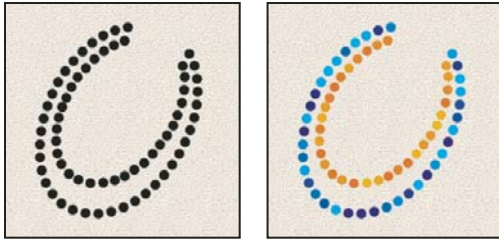

Brush strokes without color dynamics (left) and with color dynamics (right)

Foreground/Background Jitter and Control Specifies how paint varies between the foreground color and background color.

To specify a percentage by which the color of the paint can vary, type a number, or use the slider to enter a value. To specify how you want to control the color variance of brush marks, choose an option from the Control pop-up menu:

- **Off** Specifies no control over the color variance of brush marks.
- **Fade** Varies the color of paint between the foreground color and the background color in the specified number of steps.
- **Pen Pressure, Pen Tilt, Stylus Wheel, Rotation** Varies the color of paint between the foreground color and the background color based on the pen pressure, pen tilt, position of the pen thumbwheel, or rotation of the pen.

Hue Jitter Specifies a percentage by which the hue of the paint can vary in a stroke. Type a number, or use the slider to enter a value. A lower value changes the hue while maintaining a close proximity to the hue of the foreground color. A higher value increases the difference between hues.

Saturation Jitter Specifies a percentage by which the saturation of the paint can vary in a stroke. Type a number, or use the slider to enter a value. A lower value changes the saturation while maintaining a close proximity to the saturation of the foreground color. A higher value increases the difference between saturation levels.

Brightness Jitter Specifies a percentage by which the brightness of the paint can vary in a stroke. Type a number, or use the slider to enter a value. A lower value changes the brightness while maintaining a close proximity to the brightness of the foreground color. A higher value increases the difference between brightness levels.

Purity Increases or decreases the saturation of the color. Type a number, or use the slider to enter a percentage between -100 and 100. At -100%, the color is fully desaturated; at 100%, the color is fully saturated.

See also

[“Adding brush dynamics”](#) on page 339

Other dynamics brush options

Other dynamics determine how paint changes over the course of a stroke.

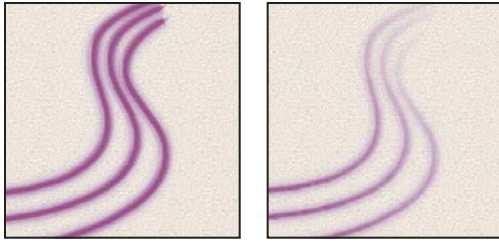

Brush strokes without paint dynamics (left) and with paint dynamics (right)

Opacity Jitter and Control Specifies how the opacity of paint varies in a brush stroke, up to (but not exceeding) the opacity value specified in the options bar. To specify a percentage by which the opacity of the paint can vary, type a number or use the slider to enter a value. To specify how you want to control the opacity variance of brush marks, choose an option from the Control pop-up menu:

- **Off** Specifies no control over the opacity variance of brush marks.
- **Fade** Fades the opacity of paint from the opacity value in the options bar to 0, in the specified number of steps.
- **Pen Pressure, Pen Tilt, Stylus Wheel** Varies the opacity of paint based on the pen pressure, pen tilt, or the position of the pen thumbwheel.

Flow Jitter and Control Specifies how the flow of paint varies in a brush stroke, up to (but not exceeding) the flow value specified in the options bar.

To specify a percentage by which the flow of the paint can vary, type a number or use the slider to enter a value. To specify how you want to control the flow variance of brush marks, choose an option from the Control pop-up menu:

- **Off** Specifies no control over the flow variance of brush marks.
- **Fade** Fades the flow of paint from the flow value in the options bar to 0 in the specified number of steps.
- **Pen Pressure, Pen Tilt, Stylus Wheel** Varies the flow of paint based on the pen pressure, pen tilt, or position of the pen thumbwheel.

See also

[“Adding brush dynamics”](#) on page 339

[“Create a brush and set painting options”](#) on page 336

Other Brush options

Noise Adds additional randomness to individual brush tips. This option is most effective when applied to soft brush tips (brush tips that contain gray values).

Wet Edges Causes paint to build up along the edges of the brush stroke, creating a watercolor effect.

Airbrush Applies gradual tones to an image, simulating traditional airbrush techniques. The Airbrush option in the Brushes panel corresponds to the Airbrush option in the options bar.

Smoothing Produces smoother curves in brush strokes. This option is most effective when you are painting quickly with a stylus; however, it may produce a slight lag time in stroke rendering.

Protect Texture Applies the same pattern and scale to all brush presets that have a texture. Select this option to simulate a consistent canvas texture when painting with multiple, textured brush tips.

Copy textures between tools

When you specify a texture for the current tool, you can copy the texture's pattern and scale to all tools that support textures. For example, you can copy the current texture pattern and scale for the Brush tool to the Pencil, Clone Stamp, Pattern Stamp, History Brush, Art History Brush, Eraser, Dodge, Burn, and Sponge tools.

- ❖ Choose Copy Texture to Other Tools from the Brushes panel menu.



Clear brush options

You can clear all options that you changed for a brush preset (except brush shape settings) at once.

- ❖ Choose Clear Brush Controls from the Brushes panel menu.

Set pen sensitivity for graphics tablets

If you work with a graphics drawing tablet, such as the Wacom® tablet, you can set the painting tools to control how color is applied depending on the pen pressure, angle, rotation, or using the stylus wheel.

- 1 Select the Brush tool , the Pencil tool , or other painting tool in the toolbox.
- 2 Click the Brushes tab to bring the Brushes panel to the front or, if the panel isn't open, choose Window > Brushes.
- 3 To make the tool tip size change with pressure, select Shape Dynamics (be sure to click the word, not just the check box) in the Brushes panel. Then choose Pen Pressure from the Controls menu under the Size Jitter slider control.
- 4 To make the opacity change with pressure, select Other Dynamics. Then choose Pen Pressure from the Controls menu under the Opacity Jitter slider control.

Note: You can set the pen pressure for other brush characteristics as well. The Brush panel contains controls that vary the angle, flow, scatter, texture depth, and roundness of the stroke according to pen pressure.

See also

[“Brushes panel overview”](#) on page 335

[“Brush shape dynamics”](#) on page 340

Blending modes

About blending modes

The blending mode specified in the options bar controls how pixels in the image are affected by a painting or editing tool. It's helpful to think in terms of the following colors when visualizing a blending mode's effect:

- The *base color* is the original color in the image.
- The *blend color* is the color being applied with the painting or editing tool.
- The *result color* is the color resulting from the blend.

See also

[“List of blending modes”](#) on page 347

List of blending modes





Choose from the Mode pop-up menu in the options bar.

Note: Only the Normal, Dissolve, Darken, Multiply, Lighten, Linear Dodge (Add), Difference, Hue, Saturation, Color, Luminosity, Lighter Color, and Darker Color blending modes are available for 32-bit images.

Normal Edits or paints each pixel to make it the result color. This is the default mode. (Normal mode is called *Threshold* when you're working with a bitmapped or indexed-color image.)

Dissolve Edits or paints each pixel to make it the result color. However, the result color is a random replacement of the pixels with the base color or the blend color, depending on the opacity at any pixel location.

Behind Edits or paints only on the transparent part of a layer. This mode works only in layers with Lock Transparency deselected and is analogous to painting on the back of transparent areas on a sheet of acetate.

Clear Edits or paints each pixel and makes it transparent. This mode is available for the Shape tools (when fill region  is selected), Paint Bucket tool , Brush tool , Pencil tool , Fill command, and Stroke command. You must be in a layer with Lock Transparency deselected to use this mode.

Darken Looks at the color information in each channel and selects the base or blend color—whichever is darker—as the result color. Pixels lighter than the blend color are replaced, and pixels darker than the blend color do not change.

Multiply Looks at the color information in each channel and multiplies the base color by the blend color. The result color is always a darker color. Multiplying any color with black produces black. Multiplying any color with white leaves the color unchanged. When you're painting with a color other than black or white, successive strokes with a painting tool produce progressively darker colors. The effect is similar to drawing on the image with multiple marking pens.

Color Burn Looks at the color information in each channel and darkens the base color to reflect the blend color by increasing the contrast. Blending with white produces no change.

Linear Burn Looks at the color information in each channel and darkens the base color to reflect the blend color by decreasing the brightness. Blending with white produces no change.

Lighten Looks at the color information in each channel and selects the base or blend color—whichever is lighter—as the result color. Pixels darker than the blend color are replaced, and pixels lighter than the blend color do not change.

Screen Looks at each channel's color information and multiplies the inverse of the blend and base colors. The result color is always a lighter color. Screening with black leaves the color unchanged. Screening with white produces white. The effect is similar to projecting multiple photographic slides on top of each other.

Color Dodge Looks at the color information in each channel and brightens the base color to reflect the blend color by decreasing the contrast. Blending with black produces no change.

Linear Dodge (Add) Looks at the color information in each channel and brightens the base color to reflect the blend color by increasing the brightness. Blending with black produces no change.

Overlay Multiplies or screens the colors, depending on the base color. Patterns or colors overlay the existing pixels while preserving the highlights and shadows of the base color. The base color is not replaced, but mixed with the blend color to reflect the lightness or darkness of the original color.

Soft Light Darkens or lightens the colors, depending on the blend color. The effect is similar to shining a diffused spotlight on the image. If the blend color (light source) is lighter than 50% gray, the image is lightened as if it were dodged. If the blend color is darker than 50% gray, the image is darkened as if it were burned in. Painting with pure black or white produces a distinctly darker or lighter area, but does not result in pure black or white.

Hard Light Multiplies or screens the colors, depending on the blend color. The effect is similar to shining a harsh spotlight on the image. If the blend color (light source) is lighter than 50% gray, the image is lightened, as if it were screened. This is useful for adding highlights to an image. If the blend color is darker than 50% gray, the image is

darkened, as if it were multiplied. This is useful for adding shadows to an image. Painting with pure black or white results in pure black or white.

Vivid Light Burns or dodges the colors by increasing or decreasing the contrast, depending on the blend color. If the blend color (light source) is lighter than 50% gray, the image is lightened by decreasing the contrast. If the blend color is darker than 50% gray, the image is darkened by increasing the contrast.

Linear Light Burns or dodges the colors by decreasing or increasing the brightness, depending on the blend color. If the blend color (light source) is lighter than 50% gray, the image is lightened by increasing the brightness. If the blend color is darker than 50% gray, the image is darkened by decreasing the brightness.

Pin Light Replaces the colors, depending on the blend color. If the blend color (light source) is lighter than 50% gray, pixels darker than the blend color are replaced, and pixels lighter than the blend color do not change. If the blend color is darker than 50% gray, pixels lighter than the blend color are replaced, and pixels darker than the blend color do not change. This is useful for adding special effects to an image.

Hard Mix Adds the red, green and blue channel values of the blend color to the RGB values of the base color. If the resulting sum for a channel is 255 or greater, it receives a value of 255; if less than 255, a value of 0. Therefore, all blended pixels have red, green, and blue channel values of either 0 or 255. This changes all pixels to primary colors: red, green, blue, cyan, yellow, magenta, white, or black.

Difference Looks at the color information in each channel and subtracts either the blend color from the base color or the base color from the blend color, depending on which has the greater brightness value. Blending with white inverts the base color values; blending with black produces no change.

Exclusion Creates an effect similar to but lower in contrast than the Difference mode. Blending with white inverts the base color values. Blending with black produces no change.

Hue Creates a result color with the luminance and saturation of the base color and the hue of the blend color.

Saturation Creates a result color with the luminance and hue of the base color and the saturation of the blend color. Painting with this mode in an area with no (0) saturation (gray) causes no change.

Color Creates a result color with the luminance of the base color and the hue and saturation of the blend color. This preserves the gray levels in the image and is useful for coloring monochrome images and for tinting color images.

Luminosity Creates a result color with the hue and saturation of the base color and the luminance of the blend color. This mode creates the inverse effect of Color mode.

Lighter Color Compares the total of all channel values for the blend and base color and displays the higher value color. Lighter Color does not produce a third color, which can result from the Lighten blend, because it chooses the highest channel values from both the base and blend color to create the result color.

Darker Color Compares the total of all channel values for the blend and base color and displays the lower value color. Darker Color does not produce a third color, which can result from the Darken blend, because it chooses the lowest channel values from both the base and the blend color to create the result color.

See also

[“About blending modes”](#) on page 346

[“Blending mode examples”](#) on page 348

Blending mode examples

These examples show the result of painting part of the image’s face using each blending mode.

For a video on blend modes, see www.adobe.com/go/vid0012.



Original Image



Normal, 100% opacity



Normal, 50% opacity



Dissolve, 50% opacity



Behind



Clear



Darken



Multiply



Color Burn



Linear Burn



Lighten



Screen



Color Dodge



Linear Dodge (Add)



Overlay



Soft Light



Hard Light



Vivid Light



Linear Light



Pin Light



Hard Mix



Difference



Exclusion



Hue



Saturation



Color



Luminosity, 80% opacity



Lighter Color



Darker Color

See also

[Using blend modes video](#)

Gradients

Apply a gradient fill

The Gradient tool creates a gradual blend between multiple colors. You can choose from preset gradient fills or create your own.

Note: The Gradient tool cannot be used with bitmap or indexed-color images.

You fill an area with a gradient by dragging in the image. The starting point (where the mouse is pressed) and ending point (where the mouse is released) affect the gradient appearance, depending on the Gradient tool used.

- 1 To fill part of the image, select the desired area. Otherwise, the gradient fill is applied to the entire active layer.
- 2 Select the Gradient tool .
- 3 Choose a gradient fill in the options bar:
 - Click the triangle next to the gradient sample to pick a preset gradient fill.
 - Click inside the gradient sample to view the Gradient Editor. Select a preset gradient fill, or create a new gradient fill. Then click OK. (See “[Create a smooth gradient](#)” on page 352.)
- 4 Select an option for applying the gradient fill in the options bar:

Linear gradient  Shades from the starting point to the ending point in a straight line.

Radial gradient  Shades from the starting point to the ending point in a circular pattern.

Angle gradient  Shades in a counterclockwise sweep around the starting point.

Reflected gradient  Shades using symmetric linear gradients on either side of the starting point.

Diamond gradient  Shades from the starting point outward in a diamond pattern. The ending point defines one corner of the diamond.

- 5 Do the following in the options bar:
 - Specify a blending mode and opacity for the paint. (See “[List of blending modes](#)” on page 347.)
 - To reverse the order of colors in the gradient fill, select Reverse.
 - To create a smoother blend with less banding, select Dither.
 - To use a transparency mask for the gradient fill, select Transparency. (See “[Specify the gradient transparency](#)” on page 353.)
- 6 Position the pointer in the image where you want to set the starting point of the gradient, and drag to define the ending point. To constrain the line angle to a multiple of 45°, hold down Shift as you drag.

Manage gradient presets

Gradient presets allow you to quickly apply gradients that you use often. You can manage your presets in the Gradient Picker, Presets Manager, or Gradient Editor.

See also

“[Work with the Preset Manager](#)” on page 41

Save a set of preset gradients as a library

- 1 Click Save in the Gradient Editor dialog box, or choose Save Gradients from the Gradient Picker menu in the options bar.
- 2 Choose a location for the gradient library, enter a file name, and click Save.

You can save the library anywhere. However, if you place the library file in the Presets/Gradients folder in the default preset location, the library name will appear at the bottom of the panel menu after you restart Photoshop.

Load a library of preset gradients

- ❖ Do one of the following in the Gradient Editor dialog box:
 - Click Load to add a library to the current list. Select the library file you want to use, and click Load.
 - Choose Replace Gradients from the panel menu to replace the current list with a different library. Select the library file you want to use, and click Load.
 - Choose a library file from the bottom of the panel menu. Click OK to replace the current list, or click Append to append the current list.

Note: You can also choose Load Gradients, Replace Gradients, or choose a library of gradients from the Gradient Picker menu in the options bar.

Return to the default library of preset gradients

- ❖ Choose Reset Gradients from the panel menu. You can either replace the current list or append the default library to the current list.

Change how preset gradients are displayed

- ❖ Choose a display option from the panel menu:

Text Only Displays the gradients as a list.

Small or Large Thumbnail Displays the gradients as thumbnails.

Small or Large List Displays the gradients as a list with thumbnails.

Rename a preset gradient

- If the panel is set to display gradients as thumbnails, double-click a gradient, enter a new name, and click OK.
- If the panel is set to display gradients as a list or text only, double-click a gradient, enter a new name inline, and press Enter (Windows) or Return (Mac OS).

Gradient Editor overview

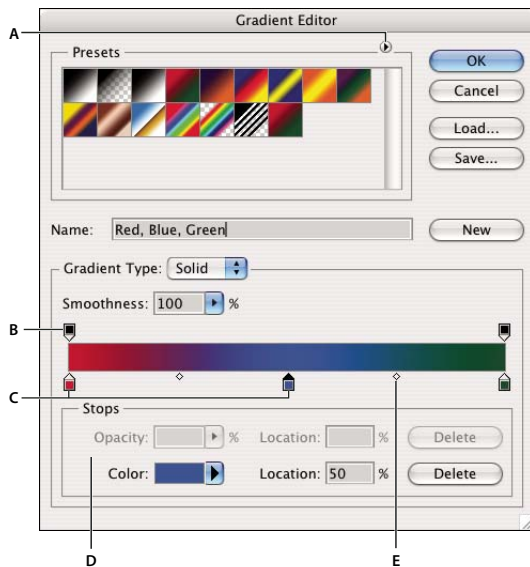

The Gradient Editor dialog box lets you define a new gradient by modifying a copy of an existing gradient. You can also add intermediate colors to a gradient, creating a blend between more than two colors.



Gradient Editor dialog box

A. Panel menu B. Opacity stop C. Color stops D. Adjust values or delete the selected opacity or color stop E. Midpoint

Create a smooth gradient

- 1 Select the Gradient tool .
- 2 Click inside the gradient sample in the options bar to display the Gradient Editor dialog box.
- 3 To base the new gradient on an existing gradient, select a gradient in the Presets section of the dialog box.
- 4 Choose Solid from the Gradient Type pop-up menu.
- 5 To define the starting color of the gradient, click the left color stop  under the gradient bar. The triangle above the stop turns black , indicating that the starting color is being edited.
- 6 To choose a color, do one of the following:
 - Double-click the color stop, or click the color swatch in the Stops section of the dialog box. Choose a color, and click OK.
 - Choose an option from the Color pop-up menu in the Stops section of the dialog box.
 - Position the pointer over the gradient bar (the pointer turns into the eyedropper), and click to sample a color, or click anywhere in the image to sample a color from the image.
- 7 To define the ending color, click the right color stop under the gradient bar. Then choose a color.

- 8 To adjust the location of the starting point or ending point, do one of the following:
 - Drag the corresponding color stop left or right to the location you want.
 - Click the corresponding color stop, and enter a value for Location in the Stops section of the dialog box. A value of 0% places the point at the far left end of the gradient bar; a value of 100%, at the far right end.
- 9 To adjust the location of the midpoint (where the gradient displays an even mix of the starting and ending colors), drag the diamond  below the gradient bar to the left or right, or click the diamond, and enter a value for Location.
- 10 To add intermediate colors to a gradient, click below the gradient bar to define another color stop. Specify the color and adjust the location and midpoint for the intermediate point as you would for a starting or ending point.
- 11 To delete the color stop you are editing, click Delete, or drag the stop downwards until it disappears.
- 12 To control how gradual the transitions are between color bands in the gradient, enter a value in the Smoothness text box, or drag the Smoothness pop-up slider.
- 13 If desired, set transparency values for the gradient.
- 14 Enter a name for the new gradient.
- 15 To save the gradient as a preset, click New after you have finished creating the gradient.

Note: *New presets are saved in a Preferences file. If this file is deleted or damaged, or if you reset presets to the default library, the new presets will be lost. To permanently save new presets, save them in a library.*

Specify the gradient transparency

Each gradient fill contains settings that control the opacity of the fill at different locations on the gradient. For example, you can set the starting color to 100% opacity and have the fill gradually blend into an ending color with 50% opacity. The checkerboard pattern indicates the amount of transparency in the gradient preview.

- 1 Create a gradient.
- 2 To adjust the starting opacity, click the left opacity stop above the gradient bar. The triangle below the stop turns black, indicating that the starting transparency is being edited.
- 3 In the Stops section of the dialog box, enter a value in the Opacity text box, or drag the Opacity pop-up slider.
- 4 To adjust the opacity of the end point, click the right transparency stop above the gradient bar. Then set the opacity in the Stops section.
- 5 To adjust the location of the starting or ending opacity, do one of the following:
 - Drag the corresponding opacity stop to the left or right.
 - Select the corresponding opacity stop, and enter a value for Location.
- 6 To adjust the location of the midpoint opacity (the point midway between the starting and ending opacities), do one of the following:
 - Drag the diamond above the gradient bar to the left or right.
 - Select the diamond and enter a value for Location.
- 7 To delete the opacity stop you are editing, click Delete.
- 8 To add an intermediate opacity to the mask, click above the gradient bar to define a new opacity stop. You can then adjust and move this opacity as you would for a starting or ending opacity. To remove an intermediate opacity, drag its transparency stop up and off the gradient bar.
- 9 To create a preset gradient, enter a name in the Name text box, and click New. This creates a new gradient preset with the transparency setting you specified.

Create a noise gradient

A noise gradient is a gradient that contains randomly distributed colors within the range of colors that you specify.



Noise gradient with different roughness values.
A. 10% roughness B. 50% roughness C. 90% roughness

- 1 Select the Gradient tool .
- 2 Click in the gradient sample in the options bar to display the Gradient Editor dialog box.
- 3 To base the new gradient on an existing gradient, select a gradient in the Presets section of the dialog box.
- 4 Choose Noise from the Gradient Type pop-up menu.
- 5 To control how gradual the transitions are between color bands in the gradient, enter a value in the Roughness text box, or drag the Roughness pop-up slider.
- 6 To define the color model, choose a color model from the Color Model list.
- 7 To adjust the range of colors, drag the sliders. For each color component of the color model you've selected, you can drag the sliders to define the range of acceptable values. For example, if you choose the HSB model, you can restrict the gradient to blue-green hues, high saturation, and medium brightness.
- 8 Set the options to restrict colors or add transparency.
- 9 To randomize a gradient that conforms to the settings, click the Randomize button until you find a setting you like.
- 10 To create a preset gradient, enter a name in the Name text box, and click New. This creates a new preset gradient with the settings you specified.

Filling and stroking selections, layers, and paths

You can fill the inside of a selection, path, or layer with a color or pattern. You can also add color to the outline of a selection or path, called stroking.

Fill with the Paint Bucket tool

The Paint Bucket tool fills adjacent pixels that are similar in color value to the pixels you click.

Note: The Paint Bucket tool cannot be used with images in Bitmap mode.

- 1 Choose a foreground color. (See “[Choose colors in the toolbox](#)” on page 114.)
- 2 Select the Paint Bucket tool .
- 3 Specify whether to fill the selection with the foreground color or with a pattern.
- 4 Specify a blending mode and opacity for the paint. (See “[List of blending modes](#)” on page 347.)
- 5 Enter the tolerance for the fill.

The tolerance defines how similar in color a pixel must be (to the pixel you click) to be filled. Values can range from 0 to 255. A low tolerance fills pixels within a range of color values very similar to the pixel you click. A high tolerance fills pixels within a broader range.

- 6 To smooth the edges of the filled selection, select Anti-aliased.
- 7 To fill only pixels contiguous to the one you click, select Contiguous; leave Contiguous unselected to fill all similar pixels in the image.
- 8 To fill pixels based on the merged color data from all visible layers, select All Layers.
- 9 Click the part of the image you want to fill. All specified pixels within the specified tolerance are filled with the foreground color or pattern.

If you're working on a layer and don't want to fill transparent areas, make sure that the layer's transparency is locked in the Layers panel. (See "Lock layers" on page 290.)

Fill a selection or layer with a color

- 1 Choose a foreground or background color. (See "Choose colors in the toolbox" on page 114.)
- 2 Select the area you want to fill. To fill an entire layer, select the layer in the Layers panel.
- 3 Choose Edit > Fill to fill the selection or layer. Or to fill a path, select the path, and choose Fill Path from the Paths panel menu.
- 4 In the Fill dialog box, choose one of the following options for Use, or select a custom pattern:

Foreground Color, Background Color, Black, 50% Gray, or White Fills the selection with the specified color.

Color Fills with a color you select from the Color Picker.

Pattern Fills the selection with a pattern. Click the inverted arrow next to the pattern sample, and select a pattern from the pop-up panel. You can load additional patterns using the pop-up panel menu. Select the name of a library of patterns, or choose Load Patterns and navigate to the folder containing the patterns you want to use.

History Restores the selected area to a state or snapshot of the image set as the source in the History panel.

Note: If you fill a CMYK image using the Black option, Photoshop fills all the channels with 100% black. This may result in more ink than is allowable by the printer. For best results when filling a CMYK image, use the Foreground option with the foreground color set to an appropriate black.

- 5 Specify the blending mode and opacity for the paint. (See "List of blending modes" on page 347.)
- 6 If you're working in a layer and want to fill only areas containing pixels, choose Preserve Transparency.
- 7 Click the OK button to apply the fill.

 To apply a foreground color fill only to the areas that contain pixels, press Alt+Shift+Backspace (Windows) or Option+Shift+Delete (Mac OS). This preserves the transparency of the layer. To apply a background color fill only to the areas that contain pixels, press Ctrl+Shift+Backspace (Windows) or Command+Shift+Delete (Mac OS).

Fill the work canvas

- 1 Set the foreground color you want to use for the canvas.
- 2 Select the Paint Bucket tool .
- 3 In the options bar, set Fill to Foreground.
- 4 Hold down Shift, and click in the work canvas.

Note: You need to be in full screen mode and viewing the menus to fill the work canvas.

Fill a selection with a pattern

- 1 Select the part of the image you want to fill.
- 2 Do one of the following:
 - Choose Edit > Fill. In the Fill dialog box, for Use, choose Pattern, select a pattern from the pop-up panel, and click OK.

If Pattern is dimmed, you need to load a pattern library before you can select this option.

- Select the Paint Bucket tool . In the options bar, choose Pattern from the Fill pop-up menu, and select a pattern from the Pattern pop-up panel. Then click to fill the selected area with the pattern.

Note: You can load additional pattern libraries into the pop-up panel prior to making a selection. (See “[Manage pattern libraries and presets](#)” on page 357.)

Stroke a selection or layer with color

You can use the Stroke command to paint a colored border around a selection, path, or layer. When you create a border this way, it becomes a rasterized part of the current layer.

 To create shape or layer borders that can be turned on or off like overlays and are anti-aliased to create softer-edged corners and edges, use the Stroke layer effect instead of the Stroke command. See “[Layer effects and styles](#)” on page 298.

- 1 Choose a foreground color.
- 2 Select the area or layer you want to stroke.
- 3 Choose Edit > Stroke.
- 4 In the Stroke dialog box, specify the width of the hard-edged border.
- 5 For Location, specify whether to place the border inside, outside, or centered over the selection or layer boundaries.

Note: If the layer contents fill the entire image, a stroke applied outside the layer will not be visible.

- 6 Specify an opacity and a blending mode. (See “[List of blending modes](#)” on page 347.)
- 7 If you’re working in a layer and want to stroke only areas containing pixels, select the Preserve Transparency option. (See “[Lock layers](#)” on page 290.)



Stroke a path with color

- 1 Select the path in the Paths panel.
- 2 Choose Stroke Path from the panel menu.
- 3 In the Stroke Path dialog box, choose a tool to stroke the path.
- 4 To simulate hand-painted strokes, select Simulate Pressure. To create more linear, even strokes, deselect this option.

Draw a circle or square

You can draw a circle or square using the elliptical or rectangular marquee tools, and then add a line (called a *stroke*) to the selection marquee. Stroking a selection is a quick way to add a border or frame around an object. You can stroke any selection you create with the selection tools.

- 1 In the Layers panel, click the New Layer button  to create a new layer for the circle or square. Isolating the circle or square on its own layer makes it easier to work with.

- 2 Select the Elliptical Marquee tool  or the Rectangular Marquee tool  in the toolbox.
- 3 Drag in the document window to create the shape. Hold down the Shift key while dragging to constrain the shape to a circle or square.
- 4 Choose Edit > Stroke.
- 5 In the Stroke dialog box, type a value for Width, and then click the color swatch to display the Adobe Color Picker.
- 6 In the Adobe Color Picker, locate the color range you want using the triangle sliders on the color spectrum bar, and then click the desired color in the color field. The color you select appears in the top half of the color swatch. The original color remains in the bottom half. Click OK.
- 7 Set the location for the stroke in relationship to the marquee by choosing Inside, Center, or Outside. Adjust the other settings as desired, and click OK. Photoshop strokes the line using the color and stroke settings you set.

See also

[“Stroke a selection or layer with color”](#) on page 356

Creating and managing patterns

About patterns

A pattern is an image that is repeated, or *tiled*, when you use it to fill a layer or selection. Photoshop comes with a variety of preset patterns.

You can create new patterns and save them in libraries for use with different tools and commands. Preset patterns are displayed in pop-up panels in the options bar for the Paint Bucket, Pattern Stamp, Healing Brush, and Patch tools, as well as in the Layer Style dialog box. You can change how patterns are displayed in the pop-up panels by choosing a display option from the pop-up panel menu. You can also manage pattern presets using the preset manager.

See also

[“Create and use tool presets”](#) on page 25

Define an image as a preset pattern

- 1 Use the Rectangle Marquee tool  on any open image to select an area to use as a pattern. Feather must be set to 0 pixels. Note that large images may become unwieldy.
- 2 Choose Edit > Define Pattern.
- 3 Enter a name for the pattern in the Pattern Name dialog box.

Note: *If you are using a pattern from one image and applying it to another, Photoshop converts the color mode.*

 *Photoshop comes with a set of Illustrator format files that you can use to define a preset pattern. Open the file, select any rendering option, and then define the pattern.*

Manage pattern libraries and presets

You can keep your patterns organized in libraries that you can load or remove from pattern pop-up panels.

Load a library of patterns

Choose one of the following from a Pattern pop-up panel menu:

- Load Patterns to add a library to the current list. Select the library file you want to use, and click Load.
- Replace Patterns to replace the current list with a different library. Select the library file you want to use, and click Load.
- A library file (displayed at the bottom of the panel menu). Click OK to replace the current list, or click Append to append the current list.

Save a set of preset patterns as a library

- 1 Choose Save Patterns from a Pattern pop-up panel menu.
- 2 Choose a location for the pattern library, enter a file name, and click Save.

You can save the library anywhere. However, if you place the library file in the Presets/Patterns folder in the default location, the library name will appear at the bottom of the Pattern pop-up panel menus after you restart Photoshop.

Return to the default library of patterns

- ❖ Choose Reset Patterns from a Pattern pop-up panel menu. You can either replace the current list or append the default library to the current list.

 *If you receive a Pattern Stamp tool preset that uses an undefined pattern, or if you erase the preset you're using by resetting or replacing the pattern library, choose New Pattern from the Pattern pop-up panel menu to redefine the pattern.*

Rename a preset pattern

- 1 Select the pattern you want to rename, and choose Rename Pattern from the panel menu.
- 2 Enter a new name for the pattern, and click OK.

Delete a preset pattern

- ❖ Do one of the following:
 - Select the pattern you want to delete, and choose Delete Pattern from the panel menu.
 - Hold down Alt (Windows) or Option (Mac OS), position the pointer over a pattern (the pointer turns into scissors), and click.

Chapter 12: Drawing

The drawing tools (the Pen and shape tools) let you create and edit vector shapes. You can work with shapes in shape layers and as paths; you can also create rasterized shapes, which can be edited with the painting tools. The drawing tools provide an easy way to create buttons, navigation bars, and other items used on web pages.

Drawing vector graphics

Drawing shapes and paths

Drawing in Adobe Photoshop CS4 involves creating vector shapes and paths. In Photoshop, you can draw with any of the shape tools, the Pen tool, or the Freeform Pen tool. Options for each tool are available in the options bar.

Before you begin drawing in Photoshop, you must choose a drawing mode from the options bar. The mode you choose to draw in determines whether you create a vector shape on its own layer, a work path on an existing layer, or a rasterized shape on an existing layer.

Vector shapes are lines and curves you draw using the shape or pen tools. Vector shapes are resolution-independent—they maintain crisp edges when resized, printed to a PostScript printer, saved in a PDF file, or imported into a vector-based graphics application. You can create libraries of custom shapes and edit a shape's outline (called a path) and attributes (such as stroke, fill color, and style).

Paths are outlines that you can turn into selections, or fill and stroke with color. The outline of a shape is a path. You can easily change the shape of a path by editing its anchor points.

A *work path* is a temporary path that appears in the Paths panel and defines the outline of a shape.

You can use paths in several ways:

- Use a path as a vector mask to hide areas of a layer. (See “[About layer and vector masks](#)” on page 319.)
- Convert a path to a selection. (See “[Convert paths to selection borders](#)” on page 380.)
- Fill or stroke a path with color. (See “[Fill paths with color](#)” on page 381.)

Designate a saved path as a clipping path to make part of an image transparent when exporting the image to a page-layout or vector-editing application. (See “[Create transparency using image clipping paths](#)” on page 469.)

Drawing modes

When you work with the shape or pen tools, you can draw in three different modes. You choose a mode by selecting an icon in the options bar when you have a shape or pen tool selected.

Shape Layers Creates a shape on a separate layer. You can use either the shape tools or the pen tools to create shape layers. Because they are easily moved, resized, aligned, and distributed, shape layers are ideal for making graphics for web pages. You can choose to draw multiple shapes on a layer. A shape layer consists of a fill layer that defines the shape color and a linked vector mask that defines the shape outline. The outline of a shape is a path, which appears in the Paths panel.

Paths Draws a work path on the current layer that you can then use to make a selection, create a vector mask, or fill and stroke with color to create raster graphics (much as you would using a painting tool). A work path is temporary unless you save it. Paths appear in the Paths panel.

Fill Pixels Paints directly on a layer—much as a painting tool does. When you work in this mode, you’re creating raster images—not vector graphics. You work with the shapes you paint just as you do with any raster image. Only the shape tools work in this mode.

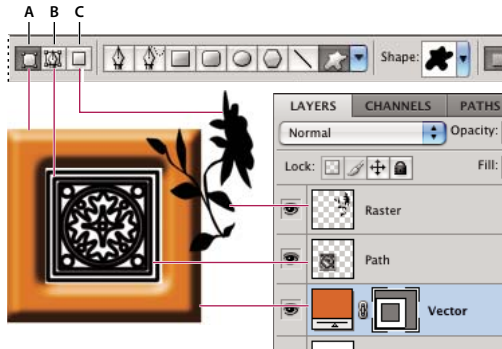

Drawing options
 A. Shape Layers B. Paths C. Fill Pixels

Drawing shapes

Create a shape on a shape layer

- 1 Select a shape tool or a Pen tool. Make sure that the Shape Layers button  is selected in the options bar.
- 2 To choose the color of the shape, click the color swatch in the options bar, and then choose a color from the Color Picker.
- 3 (Optional) Set tool options in the options bar. Click the inverted arrow next to the shape buttons to view additional options for each tool. (See “[Shape tool options](#)” on page 363.)
- 4 (Optional) To apply a style to the shape, select a preset style from the Style pop-up menu in the options bar. (See “[Apply preset styles](#)” on page 299.)
- 5 Drag in your image to draw a shape:
 - To constrain a rectangle or rounded rectangle to a square, to constrain an ellipse to a circle, or to constrain the line angle to a multiple of 45 degrees, hold down Shift.
 - To draw from the center out, position the pointer where you want the center of the shape to be, press Alt (Windows) or Option (Mac OS), and then drag diagonally to any corner or edge until the shape is the desired size.

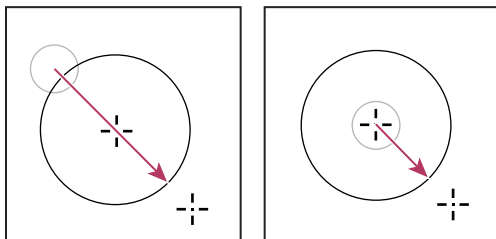

Drawing from the corner (left) and drawing from the center (right)

Note: Drawing from the center out is the default behavior of the Star tool in Illustrator and the Polygon tool in Illustrator and Photoshop.

See also

[“Edit shapes”](#) on page 362

[“Drawing and type tools gallery”](#) on page 22

Draw multiple shapes in a layer

You can draw separate shapes on a layer, or use the Add, Subtract, Intersect, or Exclude options to modify the current shape on a layer.

- 1 Select the layer to which you want to add shapes.
- 2 Select a drawing tool and set tool-specific options (see [“Shape tool options”](#) on page 363).
- 3 Choose one of the following in the options bar:

Add To Shape Area  Adds the new area to the existing shapes or path.

Subtract From Shape Area  Removes the overlapping area from the existing shapes or path.

Intersect Shape Areas  Restricts the area to the intersection of the new area and the existing shapes or path.

Exclude Overlapping Shape Areas  Excludes the overlap area in the consolidated new and existing areas.







- 4 Draw in the image. You can easily switch between drawing tools by clicking a tool button in the options bar.

See also

[“Edit shapes”](#) on page 362

Draw a wheel shape

You cut out a shape within an existing shape so that the layers underneath show through. This procedure shows you how to create a doughnut shape, but you can use this technique with any combination of the shape tools, including custom shapes.

- 1 Select the Ellipse tool  in the toolbox. It may be hidden by one of the other shape tools or the Line tool .
- 2 In the options bar at the top of the work area, select the Shape Layer button .
- 3 Drag in the document window to draw the shape. Hold down the Shift key while dragging to constrain the ellipse to a circle.
- 4 In the options bar, select the Subtract From Shape Area button .
- 5 Drag within the new shape to create the cutout. When you release the mouse, the image underneath the new shape shows through.
- 6 To reposition either shape, click the Path Selection tool  in the toolbox (it may be hidden by the Direct Selection tool ) , and select the path. Drag it to its new location or use the arrow keys on the keyboard to nudge it a pixel at a time.

 *Shift-click to select more than one path.*

See also

[“Create a shape on a shape layer”](#) on page 360

Draw a custom shape

You can draw custom shapes by using shapes from the Custom Shape pop-up panel, or save a shape or path to use as a custom shape.

- 1 Select the Custom Shape tool .
- 2 Select a shape from the Custom Shape pop-up panel in the options bar.

If you don't find a shape you want in the panel, click the arrow in the upper right corner of the panel, and choose a different category of shapes. When asked to replace current shapes, click either **Replace** to view only the shapes in the new category or **Append** to add to the shapes already displayed.

- 3 Drag in your image to draw the shape.

Save a shape or path as a custom shape

- 1 In the Paths panel, select a path—either a vector mask for a shape layer, a work path, or a saved path.
- 2 Choose **Edit > Define Custom Shape**, and enter a name for the new custom shape in the Shape Name dialog box. The new shape appears in the Shape pop-up panel.
- 3 To save the new custom shape as part of a new library, select **Save Shapes** from the pop-up panel menu.

See also

[“Work with the Preset Manager”](#) on page 41

Create a rasterized shape

When you create a rasterized shape, you're drawing and rasterizing a shape and filling it with the foreground color. You cannot edit a rasterized shape as a vector object. Raster shapes are created using the current foreground color.

- 1 Select a layer. You cannot create a rasterized shape on a vector-based layer (for example, a type layer).
- 2 Select a shape tool, and click the **Fill Pixels** button  in the options bar.
- 3 Set the following options in the options bar:

Mode Controls how the shape will affect the existing pixels in the image. (See [“List of blending modes”](#) on page 347.)

Opacity Determines to what degree the shape will obscure or reveal the pixels beneath it. A shape with 1% opacity appears nearly transparent, while one with 100% opacity appears completely opaque.

Anti-Aliased Smooths and blends the edge pixels with the surrounding pixels.

- 4 Set additional tool-specific options. See [“Shape tool options”](#) on page 363.
- 5 Draw the shape.

Edit shapes

A shape is a fill layer linked to a vector mask. You can easily change the fill to a different color, a gradient, or a pattern by editing the shape's fill layer. You can also edit the shape's vector mask to modify the shape outline, and apply a style to the layer.

- To change the color of a shape, double-click the shape layer's thumbnail in the Layers panel, and choose a different color using the Color Picker.
- To fill a shape with a pattern or gradient, select a shape layer in the Layers panel and choose **Layer > Layer Style > Gradient Overlay**, and set gradient options.

- To fill a shape with a pattern or gradient, select a shape layer in the Layers panel and choose Layer >Layer Style > Pattern Overlay, and set pattern options.
- To modify the outline of a shape, click the shape layer's vector mask thumbnail in the Layers panel or Paths panel. Then change the shape using the Direct Selection and pen tools.
- To move a shape without changing its size or proportions, hold down the spacebar while you drag the shape.

See also

[“Adjust path components”](#) on page 376

[“About adjustment layers and fill layers”](#) on page 307

[“Transform freely”](#) on page 217

Shape tool options

Selecting a shape tool changes the available options in the options bar. To access shape tool options, click the inverted arrow next to the shape button in the options bar.

Arrowheads Start And End Adds arrowheads to a line. Select the Line tool and then select Start to add an arrow to the beginning of the line; select End to add an arrow to the end of the line. Select both options to add arrows to both ends. The shape options appear in the pop-up dialog box. Enter values for Width and Length to specify the proportions of the arrowhead as a percentage of the line width (10% to 1000% for Width, and 10% to 5000% for Length). Enter a value for the concavity of the arrowhead (from -50% to +50%). The concavity value defines the amount of curvature on the widest part of the arrowhead, where the arrowhead meets the line.

Note: You can also edit an arrowhead directly using the vector selection and drawing tools.

Circle Constrains an ellipse to a circle.

Defined Proportions Renders a custom shape based on the proportions with which it was created.

Defined Size Renders a custom shape based on the size at which it was created.

Fixed Size Renders a rectangle, rounded rectangle, ellipse, or custom shape as a fixed shape based on the values you enter in the Width and Height text boxes.

From Center Renders a rectangle, rounded rectangle, ellipse, or custom shape from the center.

Indent Sides By Renders a polygon as a star. Enter a percentage in the text box to specify the portion of the star's radius taken up by the points. A 50% setting creates points that are half the total radius of the star; a larger value creates sharper, thinner points; a smaller value creates fuller points.

Proportional Renders a rectangle, rounded rectangle, or ellipse as a proportional shape based on the values you enter in the Width and Height text boxes.

Radius For rounded rectangles, specifies the corner radius. For polygons, specifies the distance from the center of a polygon to the outer points.

Sides Specifies the number of sides in a polygon.

Smooth Corners or Smooth Indents Renders a polygon with smooth corners or indents.

Snap To Pixels Snaps edges of a rectangle or rounded rectangle to the pixel boundaries.

Square Constrains a rectangle or rounded rectangle to a square.

Unconstrained Lets you set the width and height of a rectangle, rounded rectangle, ellipse, or custom shape by dragging.

Weight Determines the width, in pixels, of a line.

Drawing with the Pen tools

About the Pen tools

Photoshop provides multiple Pen tools. The standard Pen tool draws with the greatest precision; the Freeform Pen tool draws paths as if you were drawing with pencil on paper, and the magnetic pen option lets you draw a path that snaps to the edges of defined areas in your image. You can use the pen tools in conjunction with the shape tools to create complex shapes. When you use the standard Pen tool, the following options are available in the options bar:

- Auto Add/Delete, which lets you add an anchor point when you click a line segment or delete an anchor point when you click it.
- Rubber Band, which lets you preview path segments as you move the pointer between clicks.

 Before drawing with the Pen tool, you can create a new path in the Paths panel to automatically save the work path as a named path.

For more information about the modes in which you can draw with the Pen tools, see “[Drawing modes](#)” on page 359.

See also

“[Path segments, components, and points](#)” on page 372

“[Create a new work path](#)” on page 370

Draw straight line segments with the Pen tool

The simplest path you can draw with the Pen tool is a straight line, made by clicking the Pen tool to create two anchor points. By continuing to click, you create a path made of straight line segments connected by corner points.

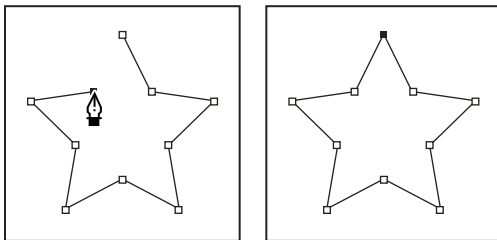

Clicking Pen tool creates straight segments.

- 1 Select the Pen tool.
- 2 Position the Pen tool where you want the straight segment to begin, and click to define the first anchor point (do not drag).

Note: The first segment you draw will not be visible until you click a second anchor point. (Select the Rubber Band option in Photoshop to preview path segments.) Also, if direction lines appear, you’ve accidentally dragged the Pen tool; choose *Edit > Undo*, and click again.

- 3 Click again where you want the segment to end (Shift-click to constrain the angle of the segment to a multiple of 45°).
- 4 Continue clicking to set anchor points for additional straight segments.

The last anchor point you add always appears as a solid square, indicating that it is selected. Previously defined anchor points become hollow, and deselected, as you add more anchor points.

5 Complete the path by doing one of the following:

- To close the path, position the Pen tool over the first (hollow) anchor point. A small circle appears next to the Pen tool pointer  when it is positioned correctly. Click or drag to close the path.

Note: To close a path in InDesign, you can also select the object and choose *Object > Paths > Close Path*.

- To leave the path open, Ctrl-click (Windows) or Command-click (Mac OS) anywhere away from all objects.

To leave the path open, you can also select a different tool, or choose *Select > Deselect* in Illustrator or *Edit > Deselect All* in InDesign.

Draw curves with the Pen tool

You create a curve by adding an anchor point where a curve changes direction, and dragging the direction lines that shape the curve. The length and slope of the direction lines determine the shape of the curve.

Curves are easier to edit and your system can display and print them faster if you draw them using as few anchor points as possible. Using too many points can also introduce unwanted bumps in a curve. Instead, draw widely spaced anchor points, and practice shaping curves by adjusting the length and angles of the direction lines.

- 1 Select the Pen tool.
- 2 Position the Pen tool where you want the curve to begin, and hold down the mouse button.

The first anchor point appears, and the Pen tool pointer changes to an arrowhead. (In Photoshop, the pointer changes only after you've started dragging.)

- 3 Drag to set the slope of the curve segment you're creating, and then release the mouse button.

In general, extend the direction line about one third of the distance to the next anchor point you plan to draw. (You can adjust one or both sides of the direction line later.)

Hold down the Shift key to constrain the tool to multiples of 45°.

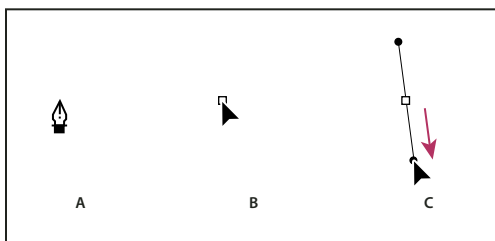

Drawing the first point in a curve

A. Positioning Pen tool B. Starting to drag (mouse button pressed) C. Dragging to extend direction lines

4 Position the Pen tool where you want the curve segment to end, and do one of the following:

- To create a C-shaped curve, drag in a direction opposite to the previous direction line. Then release the mouse button.

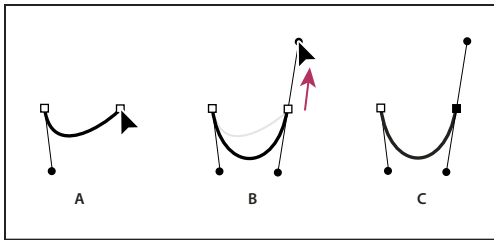

Drawing the second point in a curve

A. Starting to drag second smooth point B. Dragging away from previous direction line, creating a C curve C. Result after releasing mouse button

- To create an S-shaped curve, drag in the same direction as the previous direction line. Then release the mouse button.

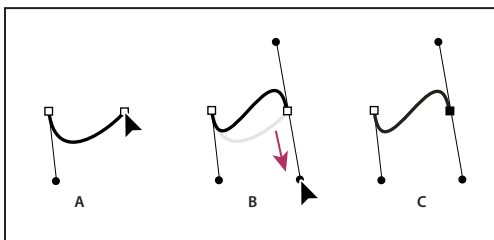

Drawing an S curve

A. Starting to drag new smooth point B. Dragging in same direction as previous direction line, creating an S curve C. Result after releasing mouse button

💡 (Photoshop only) To change the direction of the curve sharply, release the mouse button, and then Alt-drag (Windows) or Option-drag (Mac OS) the direction point in the direction of the curve. Release the Alt (Windows) or Option (Mac OS) key and the mouse button, reposition the pointer where you want the segment to end, and drag in the opposite direction to complete the curve segment.

- 5 Continue dragging the Pen tool from different locations to create a series of smooth curves. Note that you are placing anchor points at the beginning and end of each curve, not at the tip of the curve.

💡 Alt-drag (Windows) or Option-drag (Mac OS) direction lines to break out the direction lines of an anchor point.

- 6 Complete the path by doing one of the following:

- To close the path, position the Pen tool over the first (hollow) anchor point. A small circle appears next to the Pen tool pointer  when it is positioned correctly. Click or drag to close the path.

Note: To close a path in InDesign, you can also select the object and choose Object > Paths > Close Path.

- To leave the path open, Ctrl-click (Windows) or Command-click (Mac OS) anywhere away from all objects.

To leave the path open, you can also select a different tool, or choose Select > Deselect in Illustrator or Edit > Deselect All in InDesign.

For a video on using the Pen tool in Illustrator, see www.adobe.com/go/vid0037.

Finish drawing a path

- ❖ Complete a path in one of the following ways:

- To close a path, position the Pen tool over the first (hollow) anchor point. A small circle appears next to the Pen tool pointer  when it is positioned correctly. Click or drag to close the path.

Note: To close a path in InDesign, you can also select the object and choose *Object > Paths > Close Path*.

- To leave a path open, Ctrl-click (Windows) or Command-click (Mac OS) anywhere away from all objects.

To leave the path open, you can also select a different tool, or choose *Select > Deselect* in Illustrator or *Edit > Deselect All* in InDesign.

Draw straight lines followed by curves

- 1 Using the Pen tool, click corner points in two locations to create a straight segment.
- 2 Position the Pen tool over the selected endpoint. In Illustrator and InDesign, a convert-point icon appears next to the Pen tool when it is positioned correctly (In Photoshop, a small diagonal line, or slash, appears next to the Pen tool). To set the slope of the curved segment you'll create next, click the anchor point, and drag the direction line that appears.

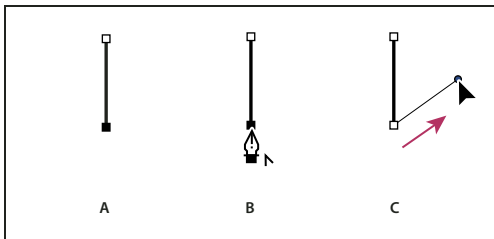

Drawing a straight segment followed by a curved segment (part 1)

- A. Straight segment completed B. Positioning Pen tool over endpoint (the Convert Point icon appears only in Illustrator and InDesign)
 C. Dragging direction point

- 3 Position the pen where you want the next anchor point; then click (and drag, if desired) the new anchor point to complete the curve.

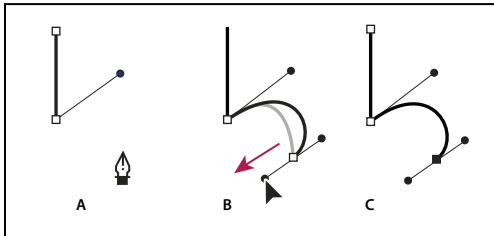

Drawing a straight segment followed by a curved segment (part 2)

- A. Positioning Pen tool B. Dragging direction line C. New curve segment completed

Draw curves followed by straight lines

- 1 Using the Pen tool, drag to create the first smooth point of the curved segment, and release the mouse button.
- 2 Reposition the Pen tool where you want the curved segment to end, drag to complete the curve, and release the mouse button.
- 3 Select the Convert Point tool from the toolbox, and then click the selected end point to convert it from a smooth point to a corner point.



Press *Alt* (Windows) or *Option* (Mac OS) to temporarily change the Pen tool to the Convert Point tool.

- 4 Select the Pen tool from the toolbox, position the Pen tool where you want the straight segment to end, and click to complete the straight segment.

Draw two curved segments connected by a corner

- 1 Using the Pen tool, drag to create the first smooth point of a curved segment.
- 2 Reposition the Pen tool and drag to create a curve with a second smooth point; then press and hold Alt (Windows) or Option (Mac OS) and drag the direction line toward its opposing end to set the slope of the next curve. Release the key and the mouse button.

This process converts the smooth point to a corner point by splitting the direction lines.

- 3 Reposition the Pen tool where you want the second curved segment to end, and drag a new smooth point to complete the second curved segment.

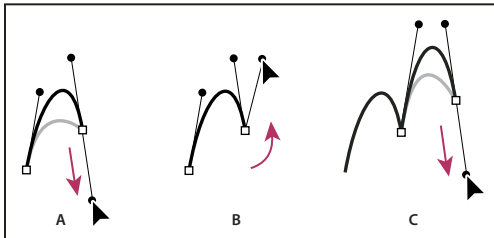

Drawing two curves

A. Dragging a new smooth point B. Pressing Alt/Option to split direction lines while dragging, and swinging direction line up C. Result after repositioning and dragging a third time

Draw with the Freeform Pen tool

The Freeform Pen tool lets you draw as if you were drawing with a pencil on paper. Anchor points are added automatically as you draw. You do not determine where the points are positioned, but you can adjust them once the path is complete. To draw with greater precision, use the Pen tool.

- 1 Select the Freeform Pen tool .
- 2 To control how sensitive the final path is to the movement of your mouse or stylus, click the inverted arrow next to the shape buttons in the options bar, and enter a value between 0.5 and 10.0 pixels for Curve Fit. A higher value creates a simpler path with fewer anchor points.
- 3 Drag the pointer in the image. As you drag, a path trails behind the pointer. When you release the mouse, a work path is created.
- 4 To continue the existing freehand path, position the pen pointer on an end point of the path, and drag.
- 5 To complete the path, release the mouse. To create a closed path, drag the line to the initial point of the path (a circle appears next to the pointer when it is aligned).

See also

[“Path segments, components, and points”](#) on page 372

Draw using the magnetic pen options

The Magnetic Pen is an option of the Freeform Pen tool that lets you draw a path that snaps to the edges of defined areas in your image. You can define the range and sensitivity of the snapping behavior, as well as the complexity of the resulting path. The Magnetic Pen and Magnetic Lasso tools share many of the same options.

- 1 To convert the Freeform Pen tool , select Magnetic in the options bar, or click the inverted arrow next to the shape buttons in the options bar, select Magnetic, and set the following:
 - For Width, enter a pixel value between 1 and 256. The Magnetic Pen detects edges only within the specified distance from the pointer.
 - For Contrast, enter a percentage value between 1 and 100 to specify the contrast required between pixels for that area to be considered an edge. Use a higher value for low-contrast images.
 - For Frequency, enter a value between 0 and 100 to specify the rate at which the Pen sets anchor points. A higher value anchors the path in place more quickly.
 - If you are working with a stylus tablet, select or deselect Pen Pressure. When this option is selected, an increase in pen pressure causes the width to decrease.
- 2 Click in the image to set the first fastening point.
- 3 To draw a freehand segment, move the pointer or drag along the edge you want to trace.

The most recent segment of the border remains active. As you move the pointer, the active segment snaps to the strongest edge in the image, connecting the pointer to the last fastening point. Periodically, the Magnetic Pen adds fastening points to the border to anchor previous sections.

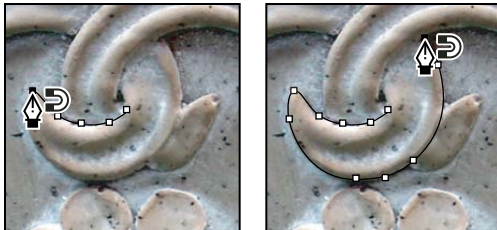

Click to add fastening points, and continue tracing.

- 4 If the border doesn't snap to the desired edge, click once to add a fastening point manually and to keep the border from moving. Continue to trace the edge and add fastening points as needed. If you make a mistake, press Delete to remove the last fastening point.
- 5 To dynamically modify the properties of the Magnetic Pen, do one of the following:
 - Alt-drag (Windows) or Option-drag (Mac OS) to draw a freehand path.
 - Alt-click (Windows) or Option-click (Mac OS) to draw straight segments.
 - Press the open square bracket key ([) to decrease the Magnetic Pen width by 1 pixel; press the close square bracket key (]) to increase the pen width by 1 pixel.
- 6 Complete the path:
 - Press Enter (Windows) or Return (Mac OS) to end an open path.
 - Double-click to close the path with a magnetic segment.
 - Hold down Alt (Windows) or Option (Mac OS), and double-click to close the path with a straight segment.

Managing paths

Paths panel overview

The Paths panel (Window > Paths) lists the name and a thumbnail image of each saved path, the current work path, and the current vector mask. Turning thumbnails off can improve performance. To view a path, you must first select it in the Paths panel.



Paths panel

A. Saved path B. Temporary work path C. Vector mask path (appears only when shape layer is selected)

Select a path

- ❖ Click the path name in the Paths panel. Only one path can be selected at a time.

Deselect a path

- ❖ Click in a blank area of the Paths panel or press Esc.

Change the size of path thumbnails

Choose Panel Options from the Paths panel menu, and select a size, or select None to turn off the display of thumbnails.

Change a path's stacking order

- ❖ Select the path in the Paths panel, and drag the path up or down. When the heavy black line appears in the desired location, release the mouse button.

Note: You cannot change the order of vector masks or working paths in the Paths panel.

Create a new path in the Paths panel

- To create a path without naming it, click the Create New Path button  at the bottom of the Paths panel.
- To create and name a path, make sure no work path is selected. Choose New Path from the Paths panel menu, or Alt-click (Windows) or Option-click (Mac OS) the New Path button at the bottom of the panel. Enter a name for the path in the New Path dialog box, and click OK.

Create a new work path

- 1 Select a shape tool or a pen tool, and click the Paths button  in the options bar.
- 2 Set tool-specific options, and draw the path. For more information, see “[Shape tool options](#)” on page 363 and “[About the Pen tools](#)” on page 364.
- 3 Draw additional path components if desired. You can easily switch between drawing tools by clicking a tool button in the options bar. Choose a path area option to determine how overlapping path components intersect:

Add To Path Area  Adds the new area to overlapping path areas.

Subtract From Path Area  Removes the new area from the overlapping path area.

Intersect Path Areas  Restricts the path to the intersection of the new area and the existing area.

Exclude Overlapping Path Areas  Excludes the overlap area in the consolidated path.

 While drawing with a shape tool, hold down *Shift* to temporarily select the *Add To Path Area* option; hold down *Alt* (Windows) or *Option* (Mac OS) to temporarily select the *Subtract From Path Area* option.

Manage paths

When you use a pen or shape tool to create a work path, the new path appears as the work path in the Paths panel. The work path is temporary; you must save it to avoid losing its contents. If you deselect the work path without saving it and start drawing again, a new path will replace the existing one.

When you use a pen or shape tool to create a new shape layer, the new path appears as a vector mask in the Paths panel. Vector masks are linked to their parent layer; you must select the parent layer in the Layers panel in order to list the Vector mask in the Paths panel. You can remove a Vector mask from a layer and convert a Vector mask to a rasterized mask. For more information, see “[Add and edit vector masks](#)” on page 323.

Paths saved with an image appear when you open it again. In Windows, JPEG, JPEG 2000, DCS, EPS, PDF, and TIFF formats support paths in Photoshop. In Mac OS, all available file formats support paths.

***Note:** Paths in formats other than those listed here generally don't survive a transition from Mac OS to Windows and back to Mac OS.*

Save a work path

- To save without renaming, drag the *work path* name to the New Path button  at the bottom of the Paths panel.
- To save and rename, choose Save Path from the Paths panel menu, enter a new path name in the Save Path dialog box, and click OK.

Rename a saved path

- ❖ Double-click the path name in the Paths panel, type a new name, and press Enter (Windows) or Return (Mac OS).

Delete a path

- 1 Click the path name in the Paths panel.
- 2 Do one of the following:
 - Drag the path to the Delete icon  at the bottom of the Paths panel.
 - Choose Delete Path from the Paths panel menu.
 - Click the Delete icon at the bottom of the Paths panel, and click Yes.

 To delete a path without being asked to confirm, *Alt-click* (Windows) or *Option-click* (Mac OS) the Delete icon at the bottom of the Paths panel.

Editing paths

Path segments, components, and points

A path consists of one or more straight or curved segments. *Anchor points* mark the end points of the path segments. On curved segments, each selected anchor point displays one or two *direction lines*, ending in *direction points*. The positions of direction lines and points determine the size and shape of a curved segment. Moving these elements reshapes the curves in a path.

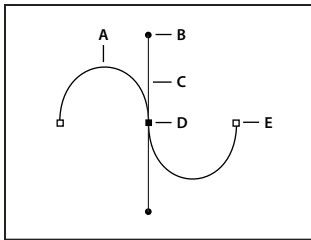

A path
 A. Curved line segment B. Direction point C. Direction line D. Selected anchor point E. Unselected anchor point

A path can be *closed*, with no beginning or end (for example, a circle), or *open*, with distinct *end points* (for example, a wavy line).

Smooth curves are connected by anchor points called *smooth points*. Sharply curved paths are connected by *corner points*.

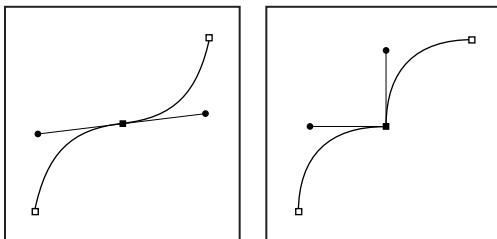

Smooth point and corner point

When you move a direction line on a smooth point, the curved segments on both sides of the point are adjusted simultaneously. By comparison, when you move a direction line on a corner point, only the curve on the same side of the point as the direction line is adjusted.

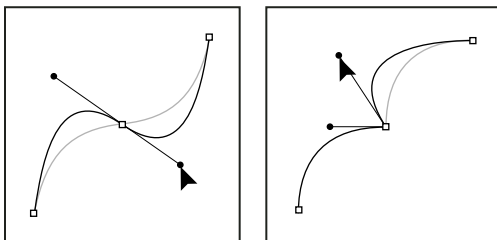

Adjusting a smooth point and a corner point

A path does not have to be one connected series of segments. It can contain more than one distinct and separate *path components*. Each shape in a shape layer is a path component, as described by the layer's clipping path.

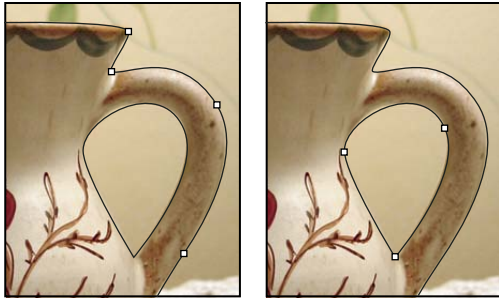



Separate path components selected

Select a path

Selecting a path component or path segment displays all of the anchor points on the selected portion, including any direction lines and direction points if the selected segment is curved. Direction points appear as filled circles, selected anchor points as filled squares, and unselected anchor points as hollow squares.

1 Do one of the following:

- To select a path component (including a shape in a shape layer), select the Path Selection tool , and click anywhere inside the path component. If a path consists of several path components, only the path component under the pointer is selected.

 *To display the bounding box along with the selected path, select Show Bounding Box in the options bar.*

- To select a path segment, select the Direct Selection tool , and click one of the segment's anchor points, or drag a marquee over part of the segment.



Drag a marquee to select segments.

2 To select additional path components or segments, select the Path Selection tool or the Direct Selection tool, and then hold down Shift while selecting additional paths or segments.

 *When the Direct Selection tool is selected, you can select the entire path or path component by Alt-clicking (Windows) or Option-clicking (Mac OS) inside the path. To activate the Direct Selection tool when most other tools are selected, position the pointer over an anchor point, and press Ctrl (Windows) or Command (Mac OS).*

See also

“[Path segments, components, and points](#)” on page 372

Adjust path segments

You can edit a path segment at any time, but editing existing segments is slightly different from drawing them. Keep the following tips in mind when editing segments:

- If an anchor point connects two segments, moving that anchor point always changes both segments.
- When drawing with the Pen tool, you can temporarily activate the Direct Selection tool (InDesign and Photoshop) so that you can adjust segments you've already drawn; press Ctrl (Windows) or Command (Mac OS) while drawing. In Illustrator, pressing Ctrl or Command while drawing activates the last-used selection tool.
- When you initially draw a smooth point with the Pen tool, dragging the direction point changes the length of the direction line on both sides of the point. However, when you edit an existing smooth point with the Direct Selection tool, you change the length of the direction line only on the side you're dragging.

Move straight segments

- 1 With the Direct Selection tool , select the segment you want to adjust.
- 2 Drag the segment to its new position.

Adjust the length or angle of straight segments

- 1 With the Direct Selection tool , select an anchor point on the segment you want to adjust.
- 2 Drag the anchor point to the desired position. Shift-drag to constrain the adjustment to multiples of 45°.

 *In Illustrator or InDesign, if you're simply trying to make a rectangle wider or narrower, it's easier to select it with the Selection tool and resize it using one of the handles on the sides of its bounding box.*

Adjust the position or shape of curved segments

- 1 With the Direct Selection tool, select a curved segment, or an anchor point on either end of the curved segment. Direction lines appear, if any are present. (Some curved segments use just one direction line.)
- 2 Do any of the following:
 - To adjust the position of the segment, drag the segment. Shift-drag to constrain the adjustment to multiples of 45°.

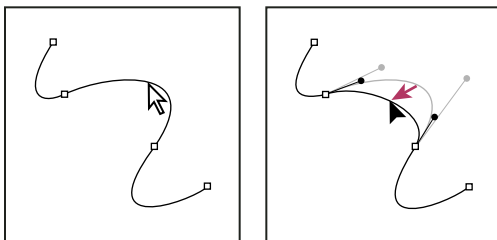

Click to select the curve segment. Then drag to adjust.

- To adjust the shape of the segment on either side of a selected anchor point, drag the anchor point or the direction point. Shift-drag to constrain movement to multiples of 45°.

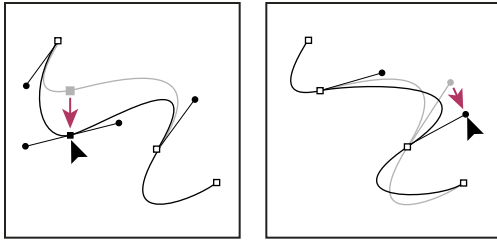

Drag the anchor point, or drag the direction point.

Note: You can also apply a transformation, such as scaling or rotating, to a segment or anchor point.

Delete a segment

- 1 Select the Direct Selection tool , and select the segment you want to delete.
- 2 Press Backspace (Windows) or Delete (Mac OS) to delete the selected segment. Pressing Backspace or Delete again erases the rest of the path.

Delete the handle of an anchor point

- Using the Convert Anchor Point Tool (Illustrator or Photoshop) or the Convert Direction Point Tool (InDesign), click the anchor point of the handle.

Extend an open path

- 1 Using the Pen tool, position the pointer over the endpoint of the open path you want to extend. The pointer changes when it's precisely positioned over the endpoint.
- 2 Click the endpoint.
- 3 Do one of the following:
 - To create a corner point, position the Pen tool where you want to end the new segment, and click. If you are extending a path that ends at a smooth point, the new segment will be curved by the existing direction line.

Note: In Illustrator, if you extend a path that ends in a smooth point, the new segment will be straight.

- To create a smooth point, position the Pen tool where you want to end the new curved segment, and drag.

Connect two open paths

- 1 Using the Pen tool, position the pointer over the endpoint of the open path that you want to connect to another path. The pointer changes when it's precisely positioned over the endpoint.
- 2 Click the endpoint.
- 3 Do one of the following:
 - To connect the path to another open path, click an endpoint on the other path. When you precisely position the Pen tool over the other path's endpoint, a small merge symbol  appears next to the pointer.
 - To connect a new path to an existing path, draw the new path near the existing path, and then move the Pen tool to the existing path's (unselected) endpoint. Click that endpoint when you see the small merge symbol that appears next to the pointer.

 In InDesign, you can also use the Pathfinder panel to join paths. To close the path of an open path, select the path and click Close Path in the Pathfinder panel. To close the end points between two paths, select the paths and click Join Path. You may want to click Join Path a second time to join the second endpoint.

Move or nudge anchor points or segments using the keyboard

- 1 Select the anchor point or path segment.

Note: In Photoshop, you can move only anchor points in this manner.

- 2 Click or hold down any of the arrow keys on the keyboard to move 1 pixel at a time in the direction of the arrow. Hold down the Shift key in addition to the arrow key to move 10 pixels at a time.

Note: In Illustrator and InDesign, you can change the distance of a nudge by changing the Keyboard Increment preference. When you change the default increment, holding down Shift nudges 10 times the specified distance.

Adjust path components

You can reposition a path component (including a shape in a shape layer) anywhere within an image. You can copy components within an image or between two Photoshop images. Using the Path Selection tool, you can merge overlapping components into a single component. All vector objects, whether they are described by a saved path, work path, or vector mask, can be moved, reshaped, copied, or deleted.

You can also use the Copy and Paste commands to duplicate vector objects between a Photoshop image and an image in another application, such as Adobe Illustrator.

See also

[“Path segments, components, and points”](#) on page 372

Change the overlap mode for the selected path component

- 1 Using the Path Selection tool , drag a marquee to select existing path areas.
- 2 Choose a shape area option in the options bar:

Add To Shape Area  Adds the path area to overlapping path areas.

Subtract From Shape Area  Removes the path area from overlapping path areas.

Intersect Shape Areas  Restricts the area to the intersection of the selected path area and overlapping path areas.

Exclude Overlapping Shape Areas  Excludes the overlap area.

Show or hide the selected path component

Do one of the following:

- Choose View > Show > Target Path.
- Choose View > Extras. This command also shows or hides a grid, guides, selection edges, annotations, and slices.

Move a path or path component

- 1 Select the path name in the Paths panel, and use the Path Selection tool  to select the path in the image. To select multiple path components, Shift-click each additional path component to add it to the selection.
- 2 Drag the path to its new location. If you move any part of a path beyond the canvas boundaries, the hidden part of the path is still available.

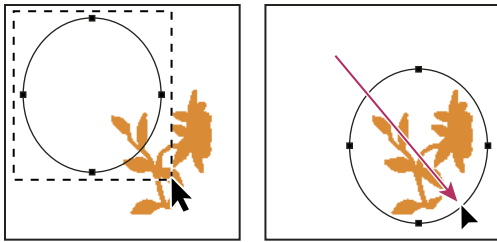

Dragging a path to a new location

Note: If you drag a path so that the move pointer is over another open image, the path is copied to that image.

Reshape a path component



- 1 Select the path name in the Paths panel, and use the Direct Selection tool  to select an anchor point in the path.
- 2 Drag the point or its handles to a new location.

Merge overlapping path components

- 1 Select the path name in the Paths panel, and select the Path Selection tool .
- 2 Click Combine in the options bar to create a single component from all overlapping components.

Copy a path component or path

Do any of the following:

- To copy a path component as you move it, select the path name in the Paths panel, and click a path component with the Path Selection tool . Then Alt-drag (Windows) or Option-drag (Mac OS) the selected path.
- To copy a path without renaming it, drag the path name in the Paths panel to the New Path button  at the bottom of the panel.
- To copy and rename a path, Alt-drag (Windows) or Option-drag (Mac OS) the path in the Paths panel to the New Path button at the bottom of the panel. Or select the path to copy, and choose Duplicate Path from the Paths panel menu. Enter a new name for the path in the Duplicate Path dialog box, and click OK.
- To copy a path or path component into another path, select the path or path component you want to copy, and choose Edit > Copy. Then select the destination path, and choose Edit > Paste.

Copy path components between two Photoshop files

- 1 Open both images.
- 2 In the source image, use the Path Selection tool  to select the entire path or the path components that you want to copy.
- 3 To copy the path component, do any of the following:
 - Drag the path component from the source image to the destination image. The path component is copied to the active path in the Paths panel.
 - In the source image, select the path name in the Paths panel and choose Edit > Copy to copy the path. In the destination image, choose Edit > Paste. You can also use this method to combine paths in the same image.
 - To paste the path component into the destination image, select the path component in the source image, and choose Edit > Copy. In the destination image, choose Edit > Paste.

Delete a path component

- 1 Select the path name in the Paths panel, and click a path component with the Path Selection tool .
- 2 Press Backspace (Windows) or Delete (Mac OS) to delete the selected path component.

Align and distribute path components

You can align and distribute path components that are described in a single path. For example, you can align the left edges of several shapes contained in a single layer or distribute several components in a work path along their horizontal centers.

Note: To align shapes that are on separate layers, use the Move tool.

- To align components, use the Path Selection tool  to select the components you want to align, and select one of the alignment options from the options bar.

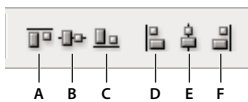

Alignment options

A. Top B. Vertical Centers C. Bottom D. Left E. Horizontal Centers F. Right

- To distribute components, select at least three components you want to distribute, and then select one of the distribute options from the options bar.

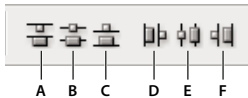



Distribute options

A. Top B. Vertical Centers C. Bottom D. Left E. Horizontal Centers F. Right

Add or delete anchor points

Adding anchor points can give you more control over a path or it can extend an open path. However, it's a good idea not to add more points than necessary. A path with fewer points is easier to edit, display, and print. You can reduce the complexity of a path by deleting unnecessary points.

The toolbox contains three tools for adding or deleting points: the Pen tool , the Add Anchor Point tool , and the Delete Anchor Point tool .

By default, the Pen tool changes to the Add Anchor Point tool as you position it over a selected path, or to the Delete Anchor Point tool as you position it over an anchor point. (In Photoshop, you must select Auto Add/Delete in the options bar to enable the Pen tool to automatically change to the Add Anchor Point or Delete Anchor Point tool.)

You can select and edit multiple paths simultaneously in Photoshop and InDesign; however, you can add or delete points to only one path at a time in Illustrator. In Photoshop and InDesign, you can reshape a path while adding anchor points by clicking and dragging as you add.

Note: Don't use the Delete or Backspace keys or the Edit > Cut or Edit > Clear commands to delete anchor points. These keys and commands delete the point and line segments that connect to that point.

Add or delete anchor points

- 1 Select the path you want to modify.
- 2 Select the Pen tool, the Add Anchor Point tool, or the Delete Anchor Point tool.

- 3 To add an anchor point, position the pointer over a path segment and click. To delete an anchor point, position the pointer over an anchor point and click.

 *In Illustrator, you can add anchor points to a path by selecting the object and choosing Object > Path > Add Anchor Points.*

Disable or temporarily override automatic Pen tool switching

You can override automatic switching of the Pen tool to the Add Anchor Point tool or the Delete Anchor Point tool. This is useful when you want to start a new path on top of an existing path.

- In Photoshop, deselect Auto Add/Delete in the options bar.
- In Illustrator or InDesign, hold down Shift as you position the Pen tool over the selected path or an anchor point. (To prevent Shift from constraining the Pen tool, release Shift before you release the mouse button.)
- In Illustrator, choose Edit > Preferences > General (Windows) or Illustrator > Preferences > General (Mac OS), and select Disable Auto Add/Delete.

Convert between smooth points and corner points

- 1 Select the path you want to modify.
- 2 Select the Convert Point tool, or use the Pen tool and hold down Alt (Windows) or Option (Mac OS).

Note: *To activate the Convert Point tool while the Direct Selection tool is selected, position the pointer over an anchor point, and press Ctrl+Alt (Windows) or Command+Option (Mac OS).*

- 3 Position the Convert Point tool over the anchor point you want to convert, and do one of the following:
 - To convert a corner point to a smooth point, drag away from the corner point to make direction lines appear.

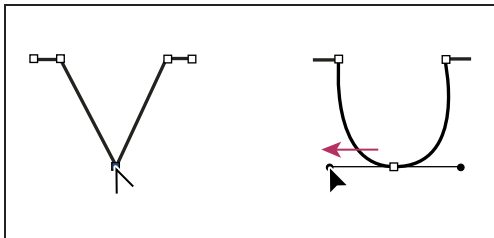

Dragging a direction point out of a corner point to create a smooth point

- To convert a smooth point to a corner point without direction lines, click the smooth point.

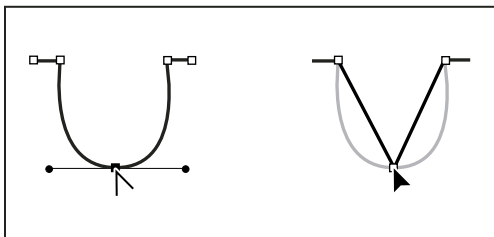

Clicking a smooth point to create a corner point

- To convert a corner point without direction lines to a corner point with independent direction lines, first drag a direction point out of a corner point (making it a smooth point with direction lines). Release the mouse button only (don't release any keys you may have pressed to activate the Convert Anchor Point tool), and then drag either direction point.

- To convert a smooth point to a corner point with independent direction lines, drag either direction point.

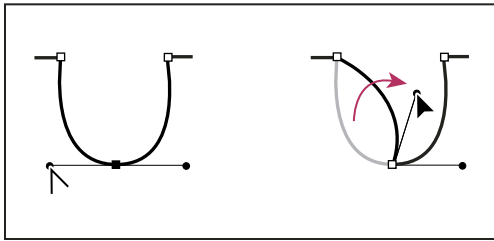

Converting a smooth point to a corner point

See also

“[Path segments, components, and points](#)” on page 372

Converting between paths and selection borders

Convert paths to selection borders

Paths provide smooth outlines that you can convert into precise selection borders. You also can convert selection borders into paths, using the Direct Selection tool  for fine-tuning.

You can define any closed path as a selection border. A closed path can be added to, subtracted from, or combined with the current selection.

Convert a path to a selection border using the current settings

- 1 Select the path in the Paths panel.
- 2 To convert the path, do one of the following:
 - Click the Load Path as a Selection button  at the bottom of the Paths panel.
 - Ctrl-click (Windows) or Command-click (Mac OS) the path thumbnail in the Paths panel.

Convert a path to a selection border and specify settings

- 1 Select the path in the Paths panel.
- 2 Do one of the following:
 - Alt-click (Windows) or Option-click (Mac OS) the Load Path As A Selection button  at the bottom of the Paths panel.
 - Alt-drag (Windows) or Option-drag (Mac OS) the path to the Load Path As A Selection button.
 - Choose Make Selection from the Paths panel menu.
- 3 In the Make Selection dialog box, select a Rendering option:

Feather Radius Defines how far inside and outside the selection border the feather edge extends. Enter a value in pixels.

Anti-aliased Creates a finer transition between the pixels in the selection and the surrounding pixels. Make sure the Feather Radius is set to 0.

For more information on these options, see “[Soften the edges of selections](#)” on page 259.

4 Select an Operation option:

New Selection Selects only the area defined by the path.

Add To Selection Adds the area defined by the path to the original selection.

Subtract From Selection Removes the area defined by the path from the current selection.

Intersect With Selection Selects the area common to both the path and the original selection. If the path and selection do not overlap, nothing is selected.

5 Click OK.

Convert a selection to a path

Any selection made with a selection tool can be defined as a path. The Make Work Path command eliminates any feathering applied to the selection. It can also alter the shape of the selection, depending on the complexity of the path and the tolerance value you choose in the Make Work Path dialog box.

1 Make the selection, and do one of the following:

- Click the Make Work Path button  at the bottom of the Paths panel to use the current tolerance setting, without opening the Make Work Path dialog box.
- Alt-click (Windows) or Option-click (Mac OS) the Make Work Path button at the bottom of the Paths panel.
- Choose Make Work Path from the Paths panel menu.

2 Enter a Tolerance value or use the default value in the Make Work Path dialog box.

Tolerance values can range from 0.5 to 10 pixels and determine how sensitive the Make Work Path command is to slight changes in the selection shape. The higher the tolerance value, the fewer the anchor points used to draw the path and the smoother the path. If the path is used as a clipping path and you have problems printing the image, use a higher tolerance value. (See “[Printing image clipping paths](#)” on page 470.)

3 Click OK. The path appears at the bottom of the Paths panel.

Adding color to paths

Fill paths with color

A path created with the Pen tool does not become an image element until you stroke or fill it. The Fill Path command fills a path with pixels using a specified color, a state of the image, a pattern, or a fill layer.

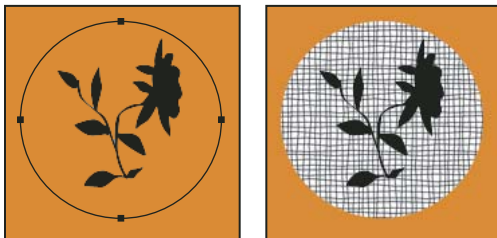

Path selected (left) and filled (right)

Important: When you fill a path, the color values appear on the active layer. Make sure that the layer you want is active before beginning. You cannot fill a path when a layer mask or text layer is active.

Fill a path using the current Fill Path settings

- 1 Select the path in the Paths panel.
- 2 Click the Fill Path button  at the bottom of the Paths panel.

Fill a path and specify options

- 1 Select the path in the Paths panel.
- 2 Fill the path:
 - Alt-click (Windows) or Option-click (Mac OS) the Fill Path button at the bottom of the Paths panel.
 - Alt-drag (Windows) or Option-drag (Mac OS) the path to the Fill Path button.
 - Choose Fill Path from the Paths panel menu. If the selected path is a path component, this command changes to Fill Subpath.
- 3 For Use, choose the contents for the fill. (See “[Fill a selection or layer with a color](#)” on page 355.)
- 4 Specify an opacity for the fill. To make the fill more transparent, use a low percentage. A setting of 100% makes the fill opaque.
- 5 Choose a blending mode for the fill. (See “[List of blending modes](#)” on page 347.)

The Mode list includes a Clear mode that lets you erase to transparency. You must be working in a layer other than the background to use this option.

- 6 Choose Preserve Transparency to limit the fill to layer areas that contain pixels. (See “[Lock layers](#)” on page 290.)
- 7 Select a Rendering option:

Feather Radius Defines how far inside and outside the selection border the feather edge extends. Enter a value in pixels.

Anti-aliased Creates a finer transition between the pixels in the selection and the surrounding pixels by partially filling the edge pixels of the selection.

For more information on these options, see “[Soften the edges of selections](#)” on page 259.

- 8 Click OK.

Stroke paths with color

The Stroke Path command paints the border of a path. The Stroke Path command allows you to create a paint stroke (using the current settings for your painting tools) that follows any path. This is completely different from the Stroke layer effect, which doesn’t mimic the effect of any of the painting tools.

Important: When you stroke a path, the color values appear on the active layer. Make sure that the layer you want is active before beginning. You cannot stroke a path when a layer mask or text layer is active.



Path selected (left) and stroked (right)

Stroke a path using the current Stroke Path settings

- 1 Select the path in the Paths panel.
- 2 Click the Stroke Path button  at the bottom of the Paths panel. Each click of the Stroke Path button builds up the opacity of the stroke and, in some cases, makes it look thicker.

Stroke a path and specify options

- 1 Select the path in the Paths panel.
- 2 Select the painting or editing tool you want to use to stroke the path. Set the tool options, and specify a brush from the options bar. You must specify the tool's settings before opening the Stroke Path dialog box. For information on specific tool settings, see [“Smudge image areas”](#) on page 204 and [“About painting tools, options, and panels”](#) on page 328.
- 3 To stroke the path, do one of the following:
 - Alt-click (Windows) or Option-click (Mac OS) the Stroke Path button  at the bottom of the Paths panel.
 - Alt-drag (Windows) or Option-drag (Mac OS) the path to the Stroke Path button.
 - Choose Stroke Path from the Paths panel menu. If the selected path is a path component, this command changes to Stroke Subpath.
- 4 If you did not select a tool in step 2, choose a tool from the Stroke Path dialog box.
- 5 Click OK.

Chapter 13: Filters

You can use filters to apply special effects to images or to perform common image editing tasks, such as sharpening photos. This section provides an overview of Adobe Photoshop CS4 filters and how to apply them to images. Complete information on using some filters is available in other sections. Search Adobe Help for information on the Sharpening, Blurring, Lens Correction, Lens Blur, Noise Reduction, Liquify, and Vanishing Point filters.

Filter basics

Using filters

You can use filters to clean up or retouch your photos, apply special art effects that give your image the appearance of a sketch or impressionistic painting, or create unique transformations using distortions and lighting effects. The filters provided by Adobe appear in the Filter menu. Some filters provided by third-party developers are available as plug-ins. Once installed, these plug-in filters appear at the bottom of the Filter menu.

Smart Filters, applied to Smart Objects, let you use filters non-destructively. Smart Filters are stored as layer effects in the Layers panel and can be readjusted at any time, working from the original image data contained in the Smart Object. For more information on Smart Filter Effects and nondestructive editing, see [“Nondestructive editing”](#) on page 309.

To use a filter, choose the appropriate submenu command from the Filter menu. These guidelines can help you in choosing filters:

- Filters are applied to the active, visible layer or a selection.
- For 8-bits-per-channel images, most filters can be applied cumulatively through the Filter Gallery. All filters can be applied individually.
- Filters cannot be applied to Bitmap-mode or indexed-color images.
- Some filters work only on RGB images.
- All filters can be applied to 8-bit images.
- The following filters can be applied to 16-bit images: Liquify, Vanishing Point, Average Blur, Blur, Blur More, Box Blur, Gaussian Blur, Lens Blur, Motion Blur, Radial Blur, Surface Blur, Shape Blur, Lens Correction, Add Noise, Despeckle, Dust & Scratches, Median, Reduce Noise, Fibers, Clouds, Difference Clouds, Lens Flare, Sharpen, Sharpen Edges, Sharpen More, Smart Sharpen, Unsharp Mask, Emboss, Find Edges, Solarize, De-Interlace, NTSC Colors, Custom, High Pass, Maximum, Minimum, and Offset.
- The following filters can be applied to 32-bit images: Average Blur, Box Blur, Gaussian Blur, Motion Blur, Radial Blur, Shape Blur, Surface Blur, Add Noise, Clouds, Lens Flare, Smart Sharpen, Unsharp Mask, De-Interlace, NTSC Colors, Emboss, High Pass, Maximum, Minimum, and Offset.
- Some filters are processed entirely in RAM. If you don't have enough available RAM to process a filter effect, you may get an error message.

See also

[“About plug-in modules”](#) on page 44

Apply a filter from the Filter menu

You can apply a filter to the active layer, or to a Smart Object. Filters applied to a Smart Object are nondestructive and can be readjusted at any time.

1 Do one of the following:

- To apply a filter to an entire layer, make sure the layer is active or selected.
- To apply a filter to an area of a layer, select that area.
- To apply a filter non-destructively so you can change your filter settings later, select the Smart Object that contains the image content you want to filter.

2 Choose a filter from the submenus in the Filter menu.

If no dialog box appears, the filter effect is applied.

3 If a dialog box or the Filter Gallery appears, enter values or select options, and then click OK.

 *Applying filters to large images can be time consuming, but you can preview the effect in the filter dialog box. Drag in the preview window to center a specific area of the image. In some filters, you can click in the image to center it where you click. Click the + or – button under the preview window to zoom in or out.*

See also

[“About Smart Filters”](#) on page 313

[“Nondestructive editing”](#) on page 309

[“Filter Gallery overview”](#) on page 385

Filter Gallery overview

The Filter Gallery provides a preview of many of the special effects filters. You can apply multiple filters, turn on or off the effect of a filter, reset options for a filter, and change the order in which filters are applied. When you are satisfied with the preview, you can then apply it to your image. Not all filters in the Filter menu are available in the Filter Gallery.

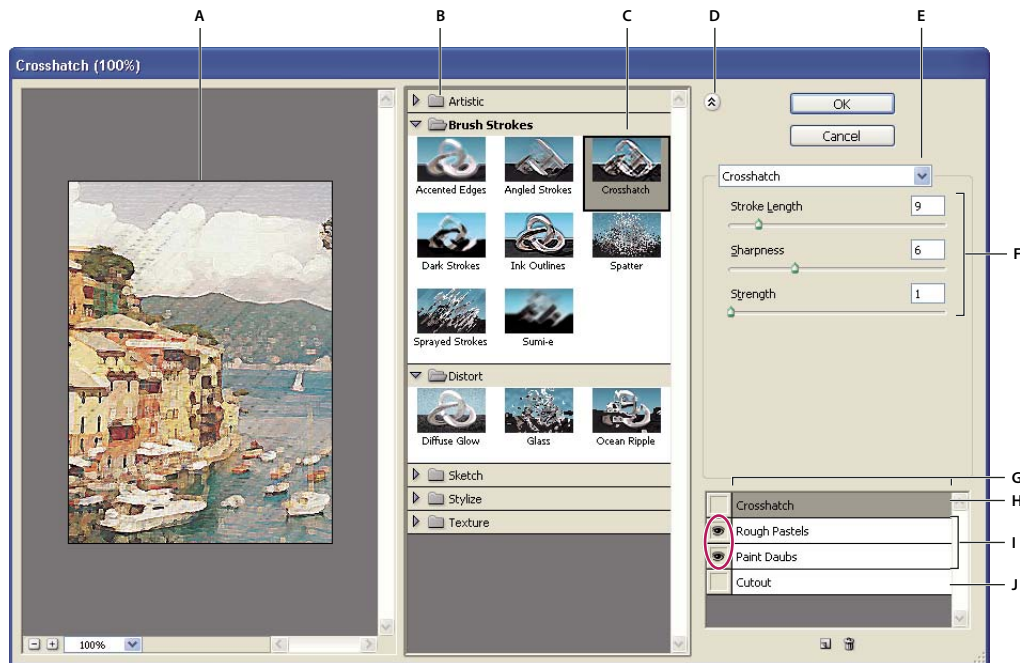

Filter Gallery dialog box

A. Preview B. Filter category C. Thumbnail of selected filter D. Show/Hide filter thumbnails E. Filters pop-up menu F. Options for selected filter G. List of filter effects to apply or arrange H. Filter effect selected but not applied I. Filter effects applied cumulatively but not selected J. Hidden filter effect

Display the Filter Gallery

❖ Choose Filter > Filter Gallery. Clicking a filter category name displays thumbnails of available filter effects.

Zoom in or out of the preview

❖ Click the + or – button under the preview area, or choose a zoom percentage.



View another area of the preview

❖ Drag in the preview area with the Hand tool

Hide filter thumbnails

❖ Click the Show/Hide button  at the top of the gallery



Apply filters from the Filter Gallery

Filter effects are applied in the order you select them. You can rearrange filters after you apply them by dragging a filter name to another position in the list of applied filters. Rearranging filter effects can dramatically change the way your image looks. Click the eye icon  next to a filter to hide the effect in the preview image. You can also delete applied filters by selecting the filter and clicking the Delete Layer icon .

 To save time when trying various filters, experiment by selecting a small, representative part of your image.

1 Do one of the following:

- To apply a filter to an entire layer, make sure that the layer is active or selected.
- To apply a filter to an area of a layer, select that area.

- To apply a filter non-destructively, so you can change your filter settings later, select the Smart Object that contains the image content that you want to filter.
- 2 Choose Filter > Filter Gallery.
 - 3 Click a filter name to add the first filter. You may need to click the inverted triangle next to the filter category to see the complete list of filters. Once added, the filter appears in the applied filter list in the lower right corner of the Filter Gallery dialog box.
 - 4 Enter values or select options for the filter you selected.
 - 5 Do any of the following:
 - To apply filters cumulatively, click the New Effect Layer icon , and choose an additional filter to apply. Repeat this procedure to add more filters.
 - To rearrange applied filters, drag the filter to a new position in the applied filter list in the lower right corner of the Filter Gallery dialog box.
 - To remove applied filters, select a filter in the applied filter list, and click the Delete Layer icon .
 - 6 When you're satisfied with the results, click OK.

See also

[“About Smart Filters”](#) on page 313

[“Nondestructive editing”](#) on page 309

[“Filter Gallery overview”](#) on page 385

Blend and fade filter effects

The Fade command changes the opacity and blending mode of any filter, painting tool, erasing tool, or color adjustment. The Fade command blending modes are a subset of those in the painting and editing tools options (excluding the Behind and Clear modes). Applying the Fade command is similar to applying the filter effect on a separate layer and then using the layer opacity and blending mode controls.

Note: The Fade command can also modify the effects of using the Liquify command and Brush Strokes filters.

- 1 Apply a filter, painting tool, or color adjustment to an image or selection.
- 2 Choose Edit > Fade. Select the Preview option to preview the effect.
- 3 Drag the slider to adjust the opacity, from 0% (transparent) to 100%.
- 4 Choose a blending mode from the Mode menu.

Note: The Color Dodge, Color Burn, Lighten, Darken, Difference, and Exclusion blending modes do not work on Lab images.

- 5 Click OK.

See also

[“About blending modes”](#) on page 346

[“About adjustment layers and fill layers”](#) on page 307

Tips for creating special effects

Creating edge effects You can use various techniques to treat the edges of an effect applied to only part of an image. To leave a distinct edge, simply apply the filter. For a soft edge, feather the edge, and then apply the filter. For a transparent effect, apply the filter, and then use the Fade command to adjust the selection's blending mode and opacity.

Applying filters to layers You can apply filters to individual layers or to several layers in succession to build up an effect. For a filter to affect a layer, the layer must be visible and must contain pixels—for example, a neutral fill color.

Applying filters to individual channels You can apply a filter to an individual channel, apply a different effect to each color channel, or apply the same filter but with different settings.

Creating backgrounds By applying effects to solid-color or grayscale shapes, you can generate a variety of backgrounds and textures. You might then blur these textures. Although some filters have little or no visible effect when applied to solid colors (for example, Glass), others produce interesting effects.

Combining multiple effects with masks or duplicate images Using masks to create selection areas gives you more control over transitions from one effect to another. For example, you can filter the selection created with a mask.

You can also use the History Brush tool to paint a filter effect onto part of the image. First, apply the filter to an entire image. Next, step back in the History panel to the image state before the filter was applied, and set the history brush source to the filtered state by clicking in the well at the left side of the history state. Then paint the image.

Improving image quality and consistency You can disguise faults, alter or enhance images, or create a relationship among images by applying the same effect to each. Use the Actions panel to record the steps you take to modify one image, and then apply this action to the other images.

Improve filter performance

Some filter effects can be memory-intensive, especially when applied to a high-resolution image.

❖ You can do any of the following to improve performance:

- Try out filters and settings on a small portion of an image.
- Apply the effect to individual channels—for example, to each RGB channel—if the image is large and you're having problems with insufficient memory. (With some filters, effects vary if applied to the individual channel rather than the composite channel, especially if the filter randomly modifies pixels.)
- Free up memory before running the filter by using the Purge command.
- Allocate more RAM to Photoshop. If necessary, exit other applications to make more memory available to Photoshop.
- Try changing settings to improve the speed of memory-intensive filters, such as Lighting Effects, Cutout, Stained Glass, Chrome, Ripple, Spatter, Sprayed Strokes, and Glass filters. (For example, with the Stained Glass filter, increase cell size. With the Cutout filter, increase Edge Simplicity, decrease Edge Fidelity, or both.)
- If you plan to print to a grayscale printer, convert a copy of the image to grayscale before applying filters. However, applying a filter to a color image, and then converting to grayscale, may not have the same effect as applying the filter to a grayscale version of the image.

See also

“Use the Undo or Redo commands” on page 45

Filter effects reference

Artistic filters

Filters from the Artistic submenu help you achieve painterly and artistic effects for a fine arts or commercial project. For example, use the Cutout filter for collages or typography. These filters replicate natural or traditional media effects. All the Artistic filters can be applied through the Filter Gallery.

Colored Pencil Draws an image using colored pencils on a solid background. Edges are retained and given a rough crosshatch appearance; the solid background color shows through the smoother areas.

 *For a parchment effect, change the background color just before applying the Colored Pencil filter to a selected area.*

Cutout Makes an image appear as though it were constructed from roughly cut pieces of colored paper. High-contrast images appear as if in silhouette, and colored images are built up from several layers of colored paper.

Dry Brush Paints the edges of the image using a dry brush technique (between oil and watercolor). The filter simplifies an image by reducing its range of colors to areas of common color.

Film Grain Applies an even pattern to the shadow tones and midtones. A smoother, more saturated pattern is added to the lighter areas. This filter is useful for eliminating banding in blends and visually unifying elements from various sources.

Fresco Paints an image in a coarse style using short, rounded, and hastily applied daubs.

Neon Glow Adds various types of glows to the objects in an image. This filter is useful for coloring an image while softening its look. To select a glow color, click the glow box, and select a color from the Color Picker.

Paint Daubs Lets you choose from various brush sizes (from 1 to 50) and types for a painterly effect. Brush types include Simple, Light Rough, Dark Rough, Wide Sharp, Wide Blurry, and Sparkle.

Palette Knife Reduces detail in an image to give the effect of a thinly painted canvas that reveals the texture underneath.

Plastic Wrap Coats the image in shiny plastic, accentuating the surface detail.

Poster Edges Reduces the number of colors in an image (posterizes it) according to the posterization option you set, and finds the edges of the image and draws black lines on them. Large broad areas have simple shading, and fine dark detail is distributed throughout the image.

Rough Pastels Applies strokes of pastel chalk on a textured background. In areas of bright color, the chalk appears thick with little texture; in darker areas, the chalk appears scraped off to reveal the texture.

Smudge Stick Softens an image using short diagonal strokes to smudge or smear the darker areas. Lighter areas become brighter and lose detail.

Sponge Creates images with highly textured areas of contrasting color, simulating the effect of sponge painting.

Underpainting Paints the image on a textured background, and then paints the final image over it.

Watercolor Paints the image in a watercolor style using a medium brush loaded with water and color, simplifying details. Where significant tonal changes occur at the edges, the filter saturates the color.

Blur filters

The Blur filters soften a selection or an entire image, and are useful for retouching. They smooth transitions by averaging the pixels next to the hard edges of defined lines and shaded areas in an image.

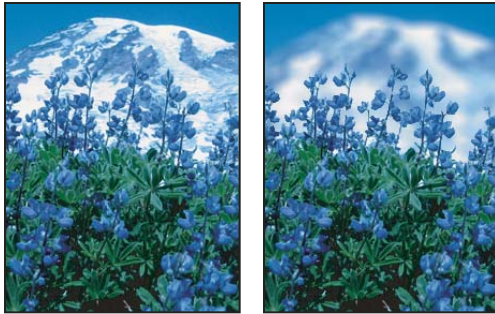

Before (left) and after (right) using the Lens Blur filter; the background is blurred but the foreground stays sharp.

Note: To apply a Blur filter to the edges of a layer, deselect the Lock Transparent Pixel option in the Layers panel.

Average Finds the average color of an image or selection, and then fills the image or selection with the color to create a smooth look. For example, if you select an area of grass, the filter changes the area into a homogeneous patch of green.

Blur and Blur More Eliminate noise where significant color transitions occur in an image. Blur filters smooth transitions by averaging the pixels next to the hard edges of defined lines and shaded areas. The effect of the Blur More filter is three or four times stronger than that of the Blur filter.

Box Blur Blurs an image based on the average color value of neighboring pixels. This filter is useful for creating special effects. You can adjust the size of the area used to calculate the average value for a given pixel; a larger radius results in greater blurring.

Gaussian Blur Quickly blurs a selection by an adjustable amount. *Gaussian* refers to the bell-shaped curve that is generated when Photoshop applies a weighted average to the pixels. The Gaussian Blur filter adds low-frequency detail and can produce a hazy effect.

Note: When Gaussian Blur, Box Blur, Motion Blur, or Shape Blur are applied to a selected image area, they will sometimes produce visually unexpected results near the edges of the selection. This is because these blur filters will use image data from outside the selected area to create the new, blurred pixels inside the selected area. For example, if the selection represents a background area that you want to blur while keeping the foreground sharp, the edges of the blurred background area will be contaminated with colors from the foreground, producing a fuzzy, muddy-looking outline around the foreground. To avoid this effect in such cases, you can use Smart Blur or Lens Blur.

Lens Blur Adds blur to an image to give the effect of a narrower depth of field so that some objects in the image stay in focus and others areas are blurred. See “Add lens blur” on page 213.

Motion Blur Blurs in the specified direction (from -360° to $+360^\circ$) and at a specified intensity (from 1 to 999). The filter’s effect is analogous to taking a picture of a moving object with a fixed exposure time.

Radial Blur Simulates the blur of a zooming or rotating camera to produce a soft blur. Choose Spin to blur along concentric circular lines, and then specify a degree of rotation. Choose Zoom to blur along radial lines, as if zooming into or out of the image, and specify a value from 1 to 100. Blur quality ranges from Draft (for fast but grainy results) or Good and Best for smoother results, which are indistinguishable from each other except on a large selection. Specify the origin of the blur by dragging the pattern in the Blur Center box.

Shape Blur Uses the specified kernel to create the blur. Choose a kernel from the list of custom shape presets, and use the radius slider to adjust its size. You can load different shape libraries by clicking the triangle and choosing from the list. Radius determines the size of the kernel; the larger the kernel, the greater the blur.

Smart Blur Blurs an image with precision. You can specify a radius, a threshold, and a blur quality. The Radius value determines the size of the area searched for dissimilar pixels. The Threshold value determines how dissimilar the pixels must be before they are affected. You also can set a mode for the entire selection (Normal) or for the edges of color

transitions (Edge Only and Overlay Edge). Where significant contrast occurs, Edge Only applies black-and-white edges, and Overlay Edge applies white.

Surface Blur Blurs an image while preserving edges. This filter is useful for creating special effects and for removing noise or graininess. The Radius option specifies the size of the area sampled for the blur. The Threshold option controls how much the tonal values of neighboring pixels must diverge from the center pixel value before being part of the blur. Pixels with tonal value differences less than the Threshold value are excluded from the blur.

Brush Stroke filters

Like the Artistic filters, the Brush Stroke filters give a painterly or fine-arts look using different brush and ink stroke effects. Some of the filters add grain, paint, noise, edge detail, or texture. All the Brush Stroke filters can be applied through the Filter Gallery.

Accented Edges Accentuates the edges of an image. When the edge brightness control is set to a high value, the accents resemble white chalk; when set to a low value, the accents resemble black ink.

Angled Strokes Repaints an image using diagonal strokes, with lighter and darker areas painted in strokes going in opposite directions.

Crosshatch Preserves the details and features of the original image while adding texture and roughening the edges of the colored areas with simulated pencil hatching. The Strength option (with values from 1 to 3) determines the number of hatching passes.

Dark Strokes Paints dark areas with short, tight, dark strokes, and lighter areas with long, white strokes.

Ink Outlines Redraws an image with fine narrow lines over the original details, in pen-and-ink style.

Spatter Replicates the effect of a spatter airbrush. Increasing the options simplifies the overall effect.

Sprayed Strokes Repaints an image, using its dominant colors, with angled, sprayed strokes of color.

Sumi-e Paints an image in Japanese style, as if with a fully saturated brush applied to rice paper. Sumi-e creates soft, blurred edges with rich, inky blacks.

Distort filters

The Distort filters geometrically distort an image, creating 3D or other reshaping effects. Note that these filters can be very memory-intensive. The Diffuse Glow, Glass, and Ocean Ripple filters can be applied through the Filter Gallery.

Diffuse Glow Renders an image as though it were viewed through a soft diffusion filter. The filter adds see-through white noise, with the glow fading from the center of a selection.

Displace Uses an image, called a *displacement map*, to determine how to distort a selection. For example, using a parabola-shaped displacement map, you can create an image that appears to be printed on a cloth held up by its corners.

Glass Makes an image appear as if it were being viewed through different types of glass. You can choose a glass effect or create your own glass surface as a Photoshop file and apply it. You can adjust scaling, distortion, and smoothness settings. When using surface controls with a file, follow the instructions for the Displace filter.

Lens Correction The Lens Correction filter fixes common lens flaws such as barrel and pincushion distortion, vignetting, and chromatic aberration.

Ocean Ripple Adds randomly spaced ripples to the surface of the image so that it appears to be underwater.

Pinch Squeezes a selection. A positive value up to 100% shifts a selection toward its center; a negative value up to -100% shifts a selection outward.

Polar Coordinates Converts a selection from its rectangular to polar coordinates, and vice versa, according to a selected option. You can use this filter to create a cylinder anamorphosis—an art form popular in the 18th century—in which the distorted image appears normal when viewed in a mirrored cylinder.

Ripple Creates an undulating pattern on a selection, like ripples on the surface of a pond. For greater control, use the Wave filter. Options include the number and size of ripples.

Shear Distorts an image along a curve. Specify the curve by dragging the line in the box. You can adjust any point along the curve. Click Default to change the curve back to a straight line. In addition, you choose how to treat undistorted areas.

Spherize Gives objects a 3D effect by wrapping a selection around a spherical shape, distorting the image and stretching it to fit the selected curve.

Twirl Rotates a selection more sharply in the center than at the edges. Specifying an angle produces a twirl pattern.

Wave Works much as the Ripple filter does, but with greater control. Options include the number of wave generators, wavelength (distance from one wave crest to the next), height of the wave, and wave type: Sine (rolling), Triangle, or Square. The Randomize option applies random values. You can also define undistorted areas.

 *To replicate wave results on other selections, click Randomize, set Number Of Generators to 1, and set the minimum and maximum Wavelength and Amplitude parameters to the same value.*

ZigZag Distorts a selection radially, depending on the radius of the pixels in your selection. The Ridges option sets the number of direction reversals of the zigzag from the center of the selection to its edge. You also specify how to displace the pixels: Pond Ripples displaces pixels to the upper-left or lower right, Out From Center displaces pixels toward or away from the center of the selection, and Around Center rotates pixels around the center.

Noise filters

The Noise filters add or remove *noise*, or pixels with randomly distributed color levels. This helps to blend a selection into the surrounding pixels. Noise filters can create unusual textures or remove problem areas, such as dust and scratches.

Add Noise Applies random pixels to an image, simulating the effect of shooting pictures on high-speed film. You can also use the Add Noise filter to reduce banding in feathered selections or graduated fills or to give a more realistic look to heavily retouched areas. Options for noise distribution include Uniform and Gaussian. Uniform distributes color values of noise using random numbers between 0 and plus or minus the specified value, creating a subtle effect. Gaussian distributes color values of noise along a bell-shaped curve, creating a speckled effect. The Monochromatic option applies the filter to only the tonal elements in the image without changing the colors.

Despeckle Detects the edges in an image (areas where significant color changes occur) and blurs all of the selection except those edges. This blurring removes noise while preserving detail.

Dust & Scratches Reduces noise by changing dissimilar pixels. To achieve a balance between sharpening the image and hiding defects, try various combinations of Radius and Threshold settings. Or apply the filter to selected areas in the image. See also “[Apply the Dust And Scratches filter](#)” on page 398.

Median Reduces noise in an image by blending the brightness of pixels within a selection. The filter searches the radius of a pixel selection for pixels of similar brightness, discarding pixels that differ too much from adjacent pixels, and replaces the center pixel with the median brightness value of the searched pixels. This filter is useful for eliminating or reducing the effect of motion on an image.

Reduce Noise Reduces noise while preserving edges based on user settings affecting the overall image or individual channels. See “[Reduce image noise and JPEG artifacts](#)” on page 208.

Pixelate filters

The filters in the Pixelate submenu sharply define a selection by clumping pixels of similar color values in cells.

Color Halftone Simulates the effect of using an enlarged halftone screen on each channel of the image. For each channel, the filter divides the image into rectangles and replaces each rectangle with a circle. The circle size is proportional to the brightness of the rectangle. See “[Apply the Color Halftone filter](#)” on page 399.

Crystallize Clumps pixels into a solid color in a polygon shape.

Facet Clumps pixels of solid or similar colors into blocks of like-colored pixels. You can use this filter to make a scanned image look hand-painted or to make a realistic image resemble an abstract painting.

Fragment Creates four copies of the pixels in the selection, averages them, and offsets them from each other.

Mezzotint Converts an image to a random pattern of black-and-white areas or of fully saturated colors in a color image. To use the filter, choose a dot pattern from the Type menu in the Mezzotint dialog box.

Mosaic Clumps pixels into square blocks. The pixels in a given block are the same color, and the colors of the blocks represent the colors in the selection.

Pointillize Breaks up the color in an image into randomly placed dots, as in a pointillist painting, and uses the background color as a canvas area between the dots.

Render filters

The Render filters create 3D shapes, cloud patterns, refraction patterns, and simulated light reflections in an image. You can also manipulate objects in 3D space, create 3D objects (cubes, spheres, and cylinders), and create texture fills from grayscale files to produce 3D-like effects for lighting.

Clouds Generates a soft cloud pattern using random values that vary between the foreground and the background colors. To generate a more stark cloud pattern, hold down Alt (Windows) or Option (Mac OS) as you choose Filter > Render > Clouds. When you apply the Clouds filter, the image data on the active layer is replaced.

Difference Clouds Uses randomly generated values that vary between the foreground and background color to produce a cloud pattern. The filter blends the cloud data with the existing pixels in the same way the Difference mode blends colors. The first time you choose this filter, portions of the image are inverted in a cloud pattern. Applying the filter several times creates rib and vein patterns that resemble a marble texture. When you apply the Difference Clouds filter, the image data on the active layer is replaced.

Fibers Creates the look of woven fibers using the foreground and background colors. You use the Variance slider to control how the colors vary (a low value produces long streaks of color, and a high value results in very short fibers with more varied distribution of color). The Strength slider controls how each fiber looks. A low setting produces a loose weave, and a high setting produces short, stringy fibers. Click the Randomize button to change how the pattern looks; you can click the button a number of times until you find a pattern you like. When you apply the Fibers filter, the image data on the active layer is replaced.



Try adding a gradient map adjustment layer to colorize the fibers.

Lens Flare Simulates the refraction caused by shining a bright light into a camera lens. Specify a location for the center of the flare by clicking anywhere inside the image thumbnail or by dragging its cross hair.

Lighting Effects Lets you produce myriad lighting effects on RGB images by varying 17 light styles, three light types, and four sets of light properties. You can also use textures from grayscale files (called *bump maps*) to produce 3D-like effects and save your own styles for use in other images. See “[Add Lighting Effects](#)” on page 400.

Sharpen filters

The Sharpen filters focus blurred images by increasing the contrast of adjacent pixels.

Sharpen and Sharpen More Focus a selection and improve its clarity. The Sharpen More filter applies a stronger sharpening effect than does the Sharpen filter.

Sharpen Edges and Unsharp Mask Find the areas in the image where significant color changes occur and sharpen them. The Sharpen Edges filter sharpens only edges while preserving the overall smoothness of the image. Use this filter to sharpen edges without specifying an amount. For professional color correction, use the Unsharp Mask filter to adjust the contrast of edge detail and produce a lighter and darker line on each side of the edge. This process emphasizes the edge and creates the illusion of a sharper image.

Smart Sharpen Sharpens an image by letting you set the sharpening algorithm or control the amount of sharpening that occurs in shadows and highlights. This is the recommended way to sharpen if you don't have a particular sharpening filter in mind. See [“Sharpen using Smart Sharpen”](#) on page 210.

See also

[“Adjusting image sharpness and blur”](#) on page 209

Sketch filters

Filters in the Sketch submenu add texture to images, often for a 3D effect. The filters also are useful for creating a fine-arts or hand-drawn look. Many of the Sketch filters use the foreground and background color as they redraw the image. All the Sketch filters can be applied through the Filter Gallery.

Bas Relief Transforms an image so that it appears carved in low relief and lit to accent the surface variations. Dark areas of the image take on the foreground color, and light colors use the background color.

Chalk & Charcoal Redraws highlights and midtones with a solid midtone gray background drawn in coarse chalk. Shadow areas are replaced with black diagonal charcoal lines. The charcoal is drawn in the foreground color; the chalk, in the background color.

Charcoal Creates a posterized, smudged effect. Major edges are boldly drawn, and midtones are sketched using a diagonal stroke. Charcoal is the foreground color, and the background is the color of the paper.

Chrome Renders the image as if it had a polished chrome surface. Highlights are high points, and shadows are low points in the reflecting surface. After applying the filter, use the Levels dialog box to add more contrast to the image.

Conté Crayon Replicates the texture of dense dark and pure white Conté crayons on an image. The Conté Crayon filter uses the foreground color for dark areas and the background color for light areas. For a truer effect, change the foreground color to one of the common Conté Crayon colors (black, sepia, or sanguine) before applying the filter. For a muted effect, change the background color to white, add some of the foreground color to the white background, and then apply the filter.

Graphic Pen Uses fine, linear ink strokes to capture the details in the original image. The effect is especially striking with scanned images. The filter replaces color in the original image, using the foreground color for ink and the background color for paper.

Halftone Pattern Simulates the effect of a halftone screen while maintaining the continuous range of tones.

Note Paper Creates an image that appears to be constructed of handmade paper. This filter simplifies images and combines the effects of the Stylize > Emboss and Texture > Grain filters. Dark areas of the image appear as holes in the top layer of paper, revealing the background color.

Photocopy Simulates the effect of photocopying an image. Large dark areas tend to be copied only around their edges, and midtones fall away to either solid black or solid white.

Plaster Molds an image from 3D plaster, and then colorizes the result using the foreground and background color. Dark areas are raised, and light areas are recessed.

Reticulation Simulates the controlled shrinking and distortion of film emulsion to create an image that appears clumped in the shadows and lightly grained in the highlights.

Stamp Simplifies the image so that it appears to be created with a rubber or wood stamp. This filter is best used with black-and-white images.

Torn Edges Reconstructs the image so that it appears composed of ragged, torn pieces of paper, and then colorizes the image using the foreground and background colors. This filter is particularly useful for text or high-contrast objects.

Water Paper Uses blotchy daubs that appear painted onto fibrous, damp paper, causing the colors to flow and blend.

Stylize filters

The Stylize filters produce a painted or impressionistic effect on a selection by displacing pixels and by finding and heightening contrast in an image. After using filters like Find Edges and Trace Contour that highlight edges, you can apply the Invert command to outline the edges of a color image with colored lines or to outline the edges of a grayscale image with white lines.

Diffuse Shuffles pixels in a selection to soften focus according to the selected option: Normal moves pixels randomly (ignoring color values), Darken Only replaces light pixels with darker ones, and Lighten Only replaces dark pixels with lighter ones. Anisotropic shuffles pixels in the direction of the least change in color.

Emboss Makes a selection appear raised or stamped by converting its fill color to gray and tracing the edges with the original fill color. Options include an embossing angle (from -360° to recess the surface, to $+360^\circ$ to raise the surface), height, and a percentage (1% to 500%) for the amount of color within the selection. To retain color and detail when embossing, use the Fade command after applying the Emboss filter.

Extrude Gives a 3D texture to a selection or layer. See “[Apply the Extrude filter](#)” on page 399.

Find Edges Identifies the areas of the image with significant transitions and emphasizes the edges. Like the Trace Counter filter, Find Edges outlines the edges of an image with dark lines against a white background and is useful for creating a border around an image.

Glowing Edges Identifies the edges of color and adds a neon-like glow to them. This filter can be applied cumulatively.

Solarize Blends a negative and a positive image—similar to exposing a photographic print briefly to light during development.

Tiles Breaks up an image into a series of tiles, creating an offset between the selection and its original position. You can choose one of the following to fill the area between the tiles: the background color, the foreground color, a reverse version of the image, or an unaltered version of the image, which puts the tiled version on top of the original and reveals part of the original image underneath the tiled edges.

Trace Contour Finds the transitions of major brightness areas and thinly outlines them for each color channel, for an effect similar to the lines in a contour map. See “[Apply the Trace Contour filter](#)” on page 399.

Wind Places tiny horizontal lines in the image to create a windblown effect. Methods include Wind; Blast, for a more dramatic wind effect; and Stagger, which offsets the lines in the image.

Texture filters

Use the Texture filters to simulate the appearance of depth or substance, or to add an organic look.

Craquelure Paints an image onto a high-relief plaster surface, producing a fine network of cracks that follow the contours of the image. Use this filter to create an embossing effect with images that contain a broad range of color or grayscale values.

Grain Adds texture to an image by simulating different kinds of grain—Regular, Soft, Sprinkles, Clumped, Contrasty, Enlarged, Stippled, Horizontal, Vertical, and Speckle, available from the Grain Type menu.

Mosaic Tiles Renders the image so that it appears to be made up of small chips or tiles and adds grout between the tiles. (In contrast, the Pixelate > Mosaic filter breaks up an image into blocks of different-colored pixels.)

Patchwork Breaks up an image into squares filled with the predominant color in that area of the image. The filter randomly reduces or increases the tile depth to replicate the highlights and shadows.

Stained Glass Repaints an image as single-colored adjacent cells outlined in the foreground color.

Texturizer Applies a texture you select or create to an image.

Video filters

The Video submenu contains the De-Interlace and NTSC Colors filters.

De-Interlace Smooths moving images captured on video by removing either the odd or even interlaced lines in a video image. You can choose to replace the discarded lines by duplication or interpolation.

NTSC Colors Restricts the gamut of colors to those acceptable for television reproduction, to prevent oversaturated colors from bleeding across television scan lines.

Other filters

Filters in the Other submenu let you create your own filters, use filters to modify masks, offset a selection within an image, and make quick color adjustments.

Custom Lets you design your own filter effect. With the Custom filter, you can change the brightness values of each pixel in the image according to a predefined mathematical operation known as *convolution*. Each pixel is reassigned a value based on the values of surrounding pixels. This operation is similar to the Add and Subtract calculations for channels.

You can save the custom filters you create and use them with other Photoshop images. See “[Create a Custom filter](#)” on page 399.

High Pass Retains edge details in the specified radius where sharp color transitions occur and suppresses the rest of the image. (A radius of 0.1 pixel keeps only edge pixels.) The filter removes low-frequency detail from an image and has an effect opposite to that of the Gaussian Blur filter.

It is helpful to apply the High Pass filter to a continuous-tone image before using the Threshold command or converting the image to Bitmap mode. The filter is useful for extracting line art and large black-and-white areas from scanned images.

Maximum and Minimum Are useful for modifying masks. The Maximum filter has the effect of applying a *choke*—spreading out white areas and choking in black areas. The Minimum filter has the effect of applying a *spread*—spreading out black areas and shrinking white areas. Like the Median filter, the Maximum and Minimum filters look at individual pixels in a selection. Within a specified radius, the Maximum and Minimum filters replace the current pixel’s brightness value with the highest or lowest brightness value of the surrounding pixels.

Offset Moves a selection a specified horizontal or vertical amount, leaving an empty space at the selection's original location. You can fill the empty area with the current background color, with another part of the image, or with your choice of fill if the selection is near the edge of an image.

Digimarc filters

The Digimarc filters embed a digital watermark into an image to store copyright information.

See also

[“Adding digital copyright information”](#) on page 465

Vanishing Point

The Vanishing Point feature preserves correct perspective in edits of images that contain perspective planes (for instance, the sides of a building or any rectangular object).

See also

[“Work in Vanishing Point”](#) on page 230

Applying specific filters

Load images and textures for filters

To produce their effects, some filters load and use other images, such as textures and displacement maps. These filters include the Conté Crayon, Displace, Glass, Lighting Effects, Rough Pastels, Texturizer, Underpainting, and Custom filters. Not all of these filters load images or textures in the same way.

- 1 Choose the filter you want from the appropriate submenu.
- 2 In the filter's dialog box, choose Load Texture from the Texture pop-up menu, and locate and open a texture image.

All textures must be in the Photoshop format. Most filters use only the grayscale information of a color file.

Set texture and glass surface controls

The Rough Pastels, Underpainting, Glass, Conté Crayon, and Texturizer filters have texturizing options. These options make images appear as if they were painted onto textures such as canvas and brick, or viewed through surfaces such as glass blocks or frosted glass.

- 1 From the Filter menu, choose Artistic > Rough Pastels, Artistic > Underpainting, Distort > Glass, Sketch > Conté Crayon, or Texture > Texturizer.
- 2 For Texture, choose a texture type or choose Load Texture to specify a Photoshop file.
- 3 Drag the Scaling slider to increase or reduce the size of the texture pattern.
- 4 Drag the Relief slider (if available) to adjust the depth of the texture's surface.
- 5 Select Invert to reverse the shadows and highlights in the texture.
- 6 For Light Direction (if available), indicate the direction from which the light source sheds light on the texture.

Defining undistorted areas

The Displace, Shear, and Wave filters in the Distort submenu and the Offset filter in the Other submenu let you treat areas undefined (or unprotected) by the filter in the following ways:

Wrap Around Fills the undefined space with content from the opposite edge of the image.

Repeat Edge Pixels Extends the colors of pixels along the edge of the image in the direction specified. Banding may result if the edge pixels are different colors.

Set To Background (Offset filter only) Fills the selected area with the current background color.

Apply the Dust And Scratches filter

- 1 Choose Filter > Noise > Dust & Scratches.
- 2 If necessary, adjust the preview zoom ratio until the area containing noise is visible.
- 3 Drag the Threshold slider left to 0 to turn off the value so that all pixels in the selection or image can be examined. The Threshold value determines how dissimilar the pixels should be before they are eliminated.

Note: The Threshold slider gives greater control for values between 0 and 128—the most common range for images—than for values between 128 and 255.

- 4 Drag the Radius slider left or right, or enter a value in the text box from 1 to 16 pixels. The Radius value determines the size of the area searched for dissimilar pixels.

Increasing the radius blurs the image. Use the smallest value that eliminates the defects.

- 5 Increase the threshold gradually by entering a value or by dragging the slider to the highest possible value that eliminates defects.

Apply the Displace filter

The Displace filter shifts a selection using a color value from the displacement map—0 is the maximum negative shift, 255 the maximum positive shift, and a gray value of 128 produces no displacement. If a map has one channel, the image shifts along a diagonal defined by the horizontal and vertical scale ratios. If the map has more than one channel, the first channel controls the horizontal displacement, and the second channel controls the vertical displacement.

The filter creates displacement maps using a flattened file saved in Adobe Photoshop format (except Bitmap mode images). You can also use the files in the Plug-Ins folder in the Photoshop program folder.

- 1 Choose Filter > Distort > Displace.
- 2 Enter the scale for the magnitude of the displacement.

When the horizontal and vertical scale are set to 100%, the greatest displacement is 128 pixels (because middle gray produces no displacement).

- 3 If the displacement map is not the same size as the selection, specify how the map fits the image—select Stretch To Fit to resize the map or Tile to fill the selection by repeating the map in a pattern.
- 4 Choose Wrap Around or Repeat Edge Pixels to determine how undistorted areas of the image are treated.
- 5 Click OK.
- 6 Select and open the displacement map. The distortion is applied to the image.

Apply the Color Halftone filter

- 1 Choose Filter > Pixelate > Color Halftone.
- 2 Enter a value in pixels for the maximum radius of a halftone dot, from 4 to 127.
- 3 Enter a screen-angle value (the angle of the dot from the true horizontal) for one or more channels:
 - For Grayscale images, use only channel 1.
 - For RGB images, use channels 1, 2, and 3, which correspond to the red, green, and blue channels.
 - For CMYK images, use all four channels, which correspond to the cyan, magenta, yellow, and black channels.
 - Click Defaults to return all the screen angles to their default values.
- 4 Click OK.

Apply the Extrude filter

- 1 Choose Filter > Stylize > Extrude.
- 2 Choose a 3D type:
 - Blocks creates objects with a square front face and four side faces. To fill the front face of each block with the average color of the block, select Solid Front Faces. To fill the front face with the image, deselect Solid Front Faces.
 - Pyramids creates objects with four triangular sides that meet at a point.
- 3 Enter a value in the Size text box to determine the length of any side of the object's base, from 2 to 255 pixels.
- 4 Enter a value in the Depth text box to indicate how far the tallest object appears to protrude from the screen, from 1 to 255.
- 5 Choose a depth option:
 - Random to give each block or pyramid an arbitrary depth.
 - Level-based to make each object's depth correspond to its brightness—bright protrudes more than dark.
- 6 Select Mask Incomplete Blocks to hide any object extending beyond the selection.

Apply the Trace Contour filter

- 1 Choose Filter > Stylize > Trace Contour.
- 2 Choose an Edge option to outline areas in the selection: Lower outlines areas where the color values of pixels fall below the specified level, and Upper outlines areas where the color values fall above.
- 3 Enter a threshold (Level) for evaluating color values (tonal level), from 0 to 255. Experiment to see what values bring out the best detail in the image.

Use the Info panel in Grayscale mode to identify a color value that you want traced. Then enter the value in the Level text box.

See also

[“Work with the Info panel”](#) on page 32

Create a Custom filter

- 1 Choose Filter > Other > Custom. The Custom dialog box displays a grid of text boxes into which you can enter numeric values.

- 2 Select the center text box, which represents the pixel being evaluated. Enter the value by which you want to multiply that pixel's brightness value, from -999 to +999.
- 3 Select a text box representing an adjacent pixel. Enter the value by which you want the pixel in this position multiplied.

For example, to multiply the brightness value of the pixel to the immediate right of the current pixel by 2, enter 2 in the text box to the immediate right of the center text box.

- 4 Repeat steps 2 and 3 for all pixels to be included in the operation. You don't have to enter values in all the text boxes.
- 5 For Scale, enter the value by which to divide the sum of the brightness values of the pixels included in the calculation.
- 6 For Offset, enter the value to be added to the result of the scale calculation.
- 7 Click OK. The custom filter is applied to each pixel in the image, one at a time.

Use the Save and Load buttons to save and reuse custom filters.

Add Lighting Effects

Apply the Lighting Effects filter

The Lighting Effects filter lets you produce myriad lighting effects on RGB images. You can also use textures from grayscale files (called *bump maps*) to produce 3D-like effects and save your own styles for use in other images.

Note: The Lighting Effects filter works only on RGB images.

- 1 Choose Filter > Render > Lighting Effects.
- 2 For Style, choose a style.
- 3 For Light Type, choose a type. If you're using multiple lights, select and deselect On to turn individual lights on and off.
- 4 To change the color of the light, click the color box in the Light Type area of the dialog box.

The Color Picker chosen in the General Preferences dialog box opens.

- 5 To set light properties, drag the corresponding slider for the following options:

Gloss Determines how much the surface reflects light (as on the surface of a piece of photographic paper), from Matte (low reflectance) to Shiny (high reflectance).

Material Determines which is more reflective: the light or the object on which the light is cast. Plastic reflects the light's color; Metallic reflects the object's color.

Exposure Increases (positive values) or decreases (negative values) light. A value of 0 has no effect.

Ambience Diffuses the light as if it were combined with other light in a room, such as sunlight or fluorescent light. Choose a value of 100 to use only the light source, or a value of -100 to remove the light source. To change the color of the ambient light, click the color box and use the Color Picker that appears.



To duplicate a light, Alt-drag (Windows) or Option-drag (Mac OS) the light within the preview window.

- 6 To use a texture fill, choose a channel for Texture Channel.

Lighting Effects types

You can choose from several lighting types:

Omni Shines light in all directions from directly above the image—like a light bulb over a piece of paper.

Directional Shines light from far away so that the light angle doesn't change—like the sun.

Spotlight Casts an elliptical beam of light. The line in the preview window defines the light direction and angle, and the handles define the edges of the ellipse.

Adjust an Omni light

- 1 Choose Filter > Render > Lighting Effects.
- 2 For Light Type, choose Omni.
- 3 Adjust the light:
 - To move the light, drag the center circle.
 - To increase or decrease the size of the light (like a light moving closer or farther away), drag one of the handles defining the edges of the effect.

Adjust directional light using the preview window

- 1 Choose Filter > Render > Lighting Effects.
- 2 For Light Type, choose Directional.
- 3 Adjust the light:
 - To move the light, drag the center circle.
 - To change the direction of the light, drag the handle at the end of the line to rotate the light's angle. Ctrl-drag (Windows) or Command-drag (Mac OS) to keep the light's height (line length) constant.
 - To change the height of the light, drag the handle at the end of the line. Shorten the line for a bright light, and lengthen it for a less intense one. A very short line produces pure white light; a very long one, no light. Shift-drag to keep the angle constant and change the height of the light (line length).

Adjust the spotlight using the preview window

- 1 Choose Filter > Render > Lighting Effects.
- 2 For Light Type, choose Spotlight.
- 3 Adjust the light:
 - To move the light, drag the center circle.
 - To increase the light angle, drag the handle to shorten the line. To decrease the light angle, drag to lengthen the line.
 - To stretch the ellipse or rotate the light, drag one of the handles. Shift-drag to keep the angle constant and change only the size of the ellipse. Ctrl-drag (Windows) or Command-drag (Mac OS) to keep the size constant and change the angle or direction of the spotlight.
 - To set the light focus (or spotlight intensity) and control how much of an ellipse is filled with light, drag the Intensity slider: full intensity (a value of 100) is brightest, normal intensity is about 50, negative intensity takes away light, and -100 intensity produces no light. Use the Focus slider to control how much of the ellipse is filled with light.

Lighting Effects styles

Use the Style menu in the Lighting Effects dialog box to choose from 17 light styles. You can also create your own lighting style by adding lights to the Default setting. The Lighting Effects filter requires at least one light source. Only one light can be edited at a time, but all added lights are used to create the effect.

2 o'clock Spotlight A yellow spotlight of medium (17) intensity with a wide (91) focus.

Blue Omni A blue overhead omni light of full (85) intensity with no focus.

Circle Of Light Four spotlights. White has full (100) intensity and a concentrated (8) focus. Yellow has strong intensity (88) and a concentrated focus (3). Red has medium (50) intensity and a concentrated (0) focus. Blue has full (100) intensity and medium (25) focus.

Crossing A white spotlight of medium (35) intensity with a wide (69) focus.

Crossing Down Two white spotlights of medium (35) intensity with a wide (100) focus.

Default A white spotlight of medium intensity (35) with a wide focus (69).

Five Lights Down/Five Lights Up Five white spotlights, down or up, of full (100) intensity with a wide (60) focus.

Flashlight An omni yellow light of medium (46) intensity.

Flood Light A white spotlight of medium (35) intensity with a wide (69) focus.

Parallel Directional A directional blue light of full (98) intensity with no focus.

RGB Lights Red, blue, and green lights that produce a light of medium (60) intensity with a wide (96) focus.

Soft Direct Lights Two unfocused white and blue directional lights. White has a soft (20) intensity. Blue has a medium (67) intensity.

Soft Omni A soft omni light of medium (50) intensity.

Soft Spotlight A white spotlight of full (98) intensity with a wide (100) focus.

Three Down Three white spotlights of soft (35) intensity with a wide (96) focus.

Triple Spotlight Three spotlights of slight (35) intensity with a wide (100) focus.

Add or delete a light

❖ In the Lighting Effects dialog box, do one of the following:

- To add a light, drag the light icon at the bottom of the dialog box into the preview area. Repeat as desired for a maximum of 16 lights.
- To delete a light, drag the light by its center circle to the Delete icon at the lower right of the preview window.

Create, save, or delete a Lighting Effects style

❖ In the Lighting Effects dialog box, do one of the following:

- To create a style, choose Default for Style and drag the light bulb icon at the bottom of the dialog box into the preview area. Repeat as desired for a maximum of 16 lights.
- To save a style, click Save, name the style, and click OK. Saved styles include all the settings for each light and appear in the Style menu whenever you open the image.
- To delete a style, choose a style, and then click Delete.

Use the Texture Channel in the Lighting Effects

The Texture Channel in the Lighting Effects dialog box lets you control lighting effects using grayscale images (called *bump maps*) that you add to your image as alpha channels. You can add any grayscale image to your image as an alpha channel, or create a new alpha channel and add texture to it. For an embossed text effect, use a channel with white text on a black background, or vice versa.

- 1 If necessary, add an alpha channel to your image. Do one of the following:
 - To use a texture based on another image (for example, fabric or water), convert that image to grayscale, then drag the grayscale channel from that image into the current image.
 - Drag an existing alpha channel from another image into the current image.
 - Create an alpha channel in your image, then add texture to it.
- 2 In the Lighting Effects dialog box, choose a channel from the Texture Channel menu: either an alpha channel you've added or the image's Red, Green, or Blue channel.
- 3 Select White Is High to raise the white parts of the channel from the surface. Deselect this option to raise the dark parts.
- 4 Drag the Height slider to vary the texture from Flat (0) to Mountainous (100).

See also

[“Create and edit alpha channel masks”](#) on page 273

Chapter 14: Type

Type in Adobe Photoshop CS4 consists of vector-based type outlines—mathematically defined shapes that describe the letters, numbers, and symbols of a *typeface*. Many typefaces are available in more than one format, the most common formats being Type 1 (also called PostScript fonts), TrueType, OpenType, New CID, and CID nonprotected (Japanese only). Photoshop preserves vector-based type outlines and uses them when you scale or resize type, save a PDF or EPS file, or print the image to a PostScript printer. As a result, it's possible to produce type with crisp, resolution-independent edges.

Creating type

About type and type layers

When you create type, a new type layer is added to the Layers panel.

Important: *Type layers aren't created for images in Multichannel, Bitmap, or Indexed Color mode, because these modes don't support layers. In these modes, type appears on the background as rasterized text.*

After you create a type layer, you can edit the type and apply layer commands to it.

Once you make a change to a type layer that requires it to be rasterized, however, Photoshop converts the vector-based type outlines to pixels. Rasterized type no longer has vector outlines and is uneditable as type. See [“Rasterize type layers”](#) on page 411.

You can make the following changes to a type layer and still edit the type:

- Change the orientation of type.
- Apply anti-aliasing.
- Convert between point type and paragraph type.
- Create a work path from type.
- Apply transformation commands from the Edit menu, except for Perspective and Distort.

Note: *To transform part of the type layer, you must first rasterize the type layer.*

- Use layer styles.
- Use fill shortcuts .
- Warp type to conform to a variety of shapes.

See also

[“Create and edit type on a path”](#) on page 429

[“Display and set Asian type options”](#) on page 434

[“Edit text”](#) on page 407

Entering type

There are three ways to create type: at a point, inside a paragraph, and along a path.

- *Point type* is a horizontal or vertical line of text that begins where you click in the image. Entering text at a point is a useful way to add a few words to your image.
- *Paragraph type* uses boundaries to control the flow of characters, either horizontally or vertically. Entering text this way is useful when you want to create one or more paragraphs, such as for a brochure.

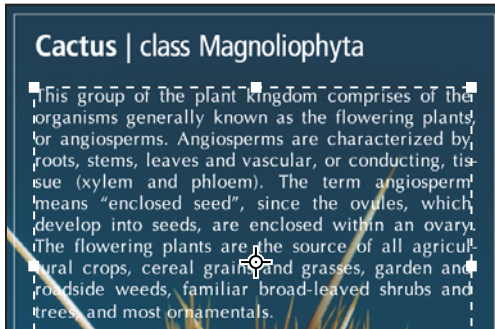

Type entered as point type (top) and in a bounding box (bottom)

- *Type on a path* flows along the edge of an open or a closed path. When you enter text horizontally, characters appear along the path perpendicular to the baseline. When you enter text vertically, characters appear along the path parallel to the baseline. In either case, the text flows in the direction in which points were added to the path.

If you enter more text that can fit within a paragraph boundary or along a path, a small box or circle containing a plus symbol (+) appears in place of a handle in the corner of the boundary or anchor point at the end of the path.

Clicking in an image with a type tool puts the type tool in edit mode. When the tool is in edit mode, you can enter and edit characters as well as perform some other commands from the various menus; however, certain operations require that you first commit changes to the type layer. To determine whether a type tool is in edit mode, look in the options bar—if you see the Commit button ✓ and the Cancel button ⓧ, the type tool is in edit mode.

See also

“[About tools](#)” on page 18

“[Create and edit type on a path](#)” on page 429

Enter point type

When you enter point type, each line of type is independent—the line expands or shrinks as you edit it, but it doesn’t wrap to the next line. The type you enter appears in a new type layer.

- 1 Select the Horizontal Type tool **T** or the Vertical Type tool **↓T**.
- 2 Click in the image to set an insertion point for the type. The small line through the I-beam marks the baseline of the type (the imaginary line on which type rests). For vertical type, the baseline marks the center axis of the characters.
- 3 Select additional type options in the options bar, Character panel, or Paragraph panel.
- 4 Enter the characters. To begin a new line, press Enter (Windows) or Return (Mac OS).

Note: You can also transform point type while in edit mode. Hold down the *Ctrl* (Windows) or *Command* (Mac OS) key. A bounding box appears around the type. You can grab a handle to scale or skew the type. You can also rotate the bounding box.

5 When you finish entering or editing the type, do one of the following:

- Click the Commit button ✓ in the options bar.
- Press the Enter key on the numeric keypad.
- Press *Ctrl+Enter* (Windows) or *Command+Return* (Mac OS).
- Select any tool in the toolbox; click in the Layers, Channels, Paths, Actions, History, or Styles panel; or select any available menu command.

Enter paragraph type

When you enter paragraph type, the lines of type wrap to fit the dimensions of the bounding box. You can enter multiple paragraphs and select a paragraph justification option.

You can resize the bounding box, causing the type to reflow within the adjusted rectangle. You can adjust the bounding box while you enter type or after you create the type layer. You can also use the bounding box to rotate, scale, and skew type.

1 Select the Horizontal Type tool **T** or the Vertical Type tool **⌞T**.

2 Do one of the following:

- Drag diagonally to define a bounding box for the type.
- Hold down *Alt* (Windows) or *Option* (Mac OS) as you click or drag to display the Paragraph Text Size dialog box. Enter values for Width and Height, and click OK.

3 Select additional type options in the options bar, Character panel, Paragraph panel, or Layer > Type submenu.

4 Enter the characters. To begin a new paragraph, press *Enter* (Windows) or *Return* (Mac OS). If you enter more type than can fit in the bounding box, the overflow icon **≡** appears on the bounding box.

5 If desired, resize, rotate, or skew the bounding box.

6 Commit the type layer by doing one of the following:

- Click the Commit button ✓ in the options bar.
- Press the Enter key on the numeric keypad.
- Press *Ctrl+Enter* (Windows) or *Command+Return* (Mac OS).
- Select any tool in the toolbox; click in the Layers, Channels, Paths, Actions, History, or Styles panel; or select any available menu command.

The type you enter appears in a new type layer.

Resize or transform a type bounding box

❖ Display the bounding box handles of paragraph type. With the Type tool **T** active, select the type layer in the Layers panel, and click in the text flow in the image.

Note: You can transform point type while in edit mode. Hold down the *Ctrl* (Windows) or *Command* (Mac OS) key, and a bounding box appears around the type.

- To resize the bounding box, position the pointer over a handle—the pointer turns into a double arrow **↔**—and drag. Shift-drag to maintain the proportions of the bounding box.

- To rotate the bounding box, position the pointer outside the bounding border—the pointer turns into a curved, two-sided arrow ↻—and drag. Shift-drag to constrain the rotation to 15° increments. To change the center of rotation, Ctrl-drag (Windows) or Command-drag (Mac OS) the center point to a new location. The center point can be outside the bounding box.
- To skew the bounding box, hold down Ctrl (Windows) or Command (Mac OS) and drag one of the middle handles. The pointer turns into an arrowhead ↗.

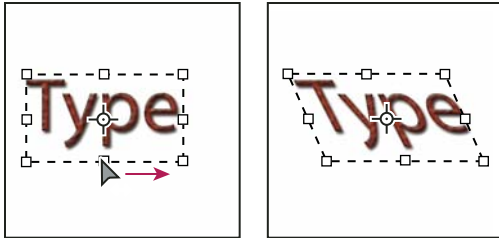

Skewing type using the bounding box

- To scale the type as you resize the bounding box, Ctrl-drag (Windows) or Command-drag (Mac OS) a corner handle.
- To resize the bounding box from the center point, Alt-drag (Windows) or Option-drag (Mac OS) a corner handle.

Convert between point type and paragraph type

You can convert point type to paragraph type to adjust the flow of characters within a bounding box. Alternatively, you can convert paragraph type to point type to make each text line flow independently from the others. When you convert from paragraph type to point type, a carriage return is added at the end of each line of type (with the exception of the last line).

- 1 Select the type layer in the Layers panel.
- 2 Choose Layer > Type > Convert To Point Text, or Layer > Type > Convert To Paragraph Text.

Note: When you convert paragraph type to point type, all characters that overflow the bounding box are deleted. To avoid losing text, adjust the bounding box so that all type is visible prior to conversion.

Editing text

Edit text

- 1 Select the Horizontal Type tool **T** or the Vertical Type tool **⌞T**.
- 2 Select the type layer in the Layers panel, or click in the text flow to automatically select a type layer.
- 3 Position the insertion point in the text, and do one of the following:
 - Click to set the insertion point.
 - Select one or more characters you want to edit.
- 4 Enter text as desired.
- 5 Do one of the following:
 - Commit the changes to the type layer.

- Cancel the changes to the type layer by clicking Cancel  or pressing ESC.

See also

“[Formatting characters](#)” on page 411

“[Formatting paragraphs](#)” on page 423

“[Line and character spacing](#)” on page 419

“[Scaling and rotating type](#)” on page 422

“[Fonts](#)” on page 415

Specify curly or straight quotes

Typographer’s quotes, often called curly quotes or smart quotes, blend in with the curves of the font. *Typographer’s quotes* are traditionally used for quotation marks and apostrophes. *Straight quotes* are traditionally used as abbreviations for feet and inches.

- 1 Choose Edit > Preferences > Type (Windows) or Photoshop > Preferences > Type (Mac OS).
- 2 Under Type Options, select or deselect Use Smart Quotes.

Apply anti-aliasing to a type layer

Anti-aliasing produces smooth-edged type by partially filling the edge pixels. As a result, the edges of the type blend into the background.

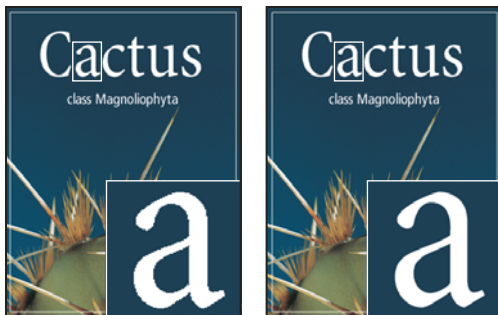

Anti-aliasing set to None (left), and Strong (right)

When creating type for display on the web, consider that anti-aliasing greatly increases the number of colors in the original image. This limits your ability to reduce the number of colors in the image and thus to reduce the size of the image file. Anti-aliasing may also cause stray colors to appear along the edges of the type. When reducing file size and limiting the number of colors are most important, it may be preferable to avoid anti-aliasing, despite the jagged edges. Also, consider using larger type than you would use for print. Larger type is easier to view on the web and gives you more freedom in deciding whether to apply anti-aliasing.

Note: *When you use anti-aliasing, type may be rendered inconsistently at small sizes and low resolutions (such as the resolution used for web graphics). To reduce this inconsistency, deselect the Fractional Width option in the Character panel menu.*

- 1 Select the type layer in the Layers panel.

- 2 Choose an option from the anti-aliasing menu **aa** in the options bar or the Character panel. Or, choose Layer > Type, and choose an option from the submenu.

None Applies no anti-aliasing

Sharp Type appears at its sharpest

Crisp Type appears somewhat sharp

Strong Type appears heavier

Smooth Type appears smoother

Check and correct spelling

When you check the spelling in a document, Photoshop questions any words that aren't in its dictionary. If a questioned word is spelled correctly, you can confirm its spelling by adding the word to your personal dictionary. If a questioned word is misspelled, you can correct it.

- 1 If necessary, in the Character panel, choose a language from the pop-up menu at the bottom of the panel. This is the dictionary Photoshop uses to check spelling.
- 2 (Optional) Show or unlock type layers. The Check Spelling command does not check spelling in hidden or locked layers.
- 3 Do one of the following:
 - Select a type layer.
 - To check specific text, select the text.
 - To check a word, place the insertion point in the word.
- 4 Choose Edit > Check Spelling.
- 5 If you selected a type layer and want to check the spelling of only that layer, deselect Check All Layers.
- 6 As Photoshop finds unfamiliar words and other possible errors, click one of the following:

Ignore Continues the spelling check without changing the text.

Ignore All Ignores the questioned word during the rest of the spelling check.

Change Corrects a misspelling. Make sure that the correctly spelled word is in the Change To text box and click Change. If the suggested word is not the word you want, select a different word in the Suggestions text box or enter the correct word in the Change To text box.

Change All Corrects all instances of the misspelling in the document. Make sure the correctly spelled word is in the Change To text box.

Add Stores the unrecognized word in the dictionary, so that subsequent occurrences are not flagged as misspellings.

Find and replace text

- 1 Do one of the following:
 - Select the layer containing the text you want to find and replace. Place the insertion point at the beginning of the text you want to search.
 - Select a nontype layer if you have more than one text layer and you want to search all layers in the document.

Note: In the Layers panel, make sure the text layers you want to search are visible and unlocked. The Find And Replace Text command does not check spelling in hidden or locked layers.

- 2 Choose Edit > Find And Replace Text.
- 3 In the Find What box, type or paste the text you want to find. To change the text, type the new text in the Change To text box.
- 4 Select one or more options to refine your search.

Search All Layers Searches all layers in a document. This option is available when a nontype layer is selected in the Layers panel.

Forward Searches forward from an insertion point in the text. Deselect this option to search all the text in a layer, regardless of where the insertion point is placed.

Case Sensitive Searches for a word or words that exactly match the case of the text in the Find What text box. For example, with the Case Sensitive option selected, a search for “PrePress” does not find “Prepress” or “PREPRESS.”

Whole Word Only Disregards the search text if it is embedded in a larger word. For example, if you are searching for “any” as a whole word, “many” is disregarded.

- 5 Click Find Next to begin the search.
- 6 Click one of the following buttons.

Change Replaces the found text with the revised text. To repeat the search, select Find Next.

Change All Searches for and replaces all occurrences of the found text.

Change/Find Replaces the found text with the revised text, and then searches for the next occurrence.

Assign a language for text

Photoshop uses language dictionaries to check hyphenation. Language dictionaries are also used to check spelling. Each dictionary contains hundreds of thousands of words with standard syllable breaks. You can assign a language to an entire document or apply a language to selected text.

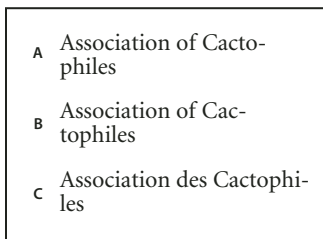

Examples of hyphenation for different languages

A. “Cactophiles” in English USA **B.** “Cactophiles” in English UK **C.** “Cactophiles” in French

- 1 Do one of the following:
 - To enter text using a specific language dictionary, choose the dictionary from the pop-up menu in the bottom left corner of the Character panel. Then enter the text.
 - To change the dictionary of existing text, select the text and choose the dictionary from the pop-up menu in the bottom left corner of the Character panel.
- 2 In the Character panel, choose the appropriate dictionary from the pop-up menu in the bottom left corner of the panel.

Note: If you select text with multiple languages or if the type layer has multiple languages, the pop-up menu in the Character panel will be dimmed and it will display the word “Multiple.”

Change the orientation of a type layer

The orientation of a type layer determines the direction of type lines in relation to the document window (for point type) or the bounding box (for paragraph type). When a type layer is vertical, the type flows up and down; when a type layer is horizontal, the type flows from left to right. Don't confuse the orientation of a type layer with the direction of characters in a type line.

- 1 Select the type layer in the Layers panel.
- 2 Do one of the following:
 - Select a type tool, and click the Text Orientation button  in the options bar.
 - Choose Layer > Type > Horizontal, or choose Layer > Type > Vertical.
 - Choose Change Text Orientation from the Character panel menu.

Rasterize type layers

Some commands and tools—such as filter effects and painting tools—are not available for type layers. You must rasterize the type before applying the command or using the tool. *Rasterizing* converts the type layer into a normal layer and makes its contents uneditable as text. A warning message appears if you choose a command or tool that requires a rasterized layer. Some warning messages provide an OK button you can click to rasterize the layer.

- ❖ Select the type layer and choose Layer > Rasterize > Type.

Formatting characters

About character formatting

You can set type attributes before you enter characters or reset them to change the appearance of selected characters in a type layer.



Before you can format individual characters, you must select them. You can select one character, a range of characters, or all characters in a type layer.

See also

[“Line and character spacing”](#) on page 419

[“Formatting paragraphs”](#) on page 423

Select characters

- 1 Select the Horizontal Type tool  or the Vertical Type tool .
- 2 Select the type layer in the Layers panel, or click in the text to automatically select a type layer.
- 3 Position the insertion point in the text, and do one of the following:
 - Drag to select one or more characters.
 - Click in the text, and then Shift-click to select a range of characters.
 - Choose Select > All to select all the characters in the layer.
 - Double-click a word to select it. Triple-click a line to select it. Quadruple-click a paragraph to select it. Quintuple-click anywhere in the text flow to select all characters in a bounding box.

- To use the arrow keys to select characters, click in the text, and then hold down Shift and press the Right Arrow or Left Arrow key. To use the keys to select words, hold down Shift+Ctrl (Windows) or Shift+Command (Mac OS) and press the Right Arrow or Left Arrow key.
- 4 To select all the characters in a layer without positioning the insertion point in the text flow, select the type layer in the Layers panel, and then double-click the layer's type icon.

Important: Selecting and formatting characters in a type layer puts the Type tool into edit mode.

Character panel overview

The Character panel provides options for formatting characters. Some formatting options are also available from the options bar.

You can display the Character panel by doing one of the following:

- Choose Window > Character, or click the Character panel tab if the panel is visible but not active.
- With a type tool selected, click the Panel button  in the options bar.

To set an option in the Character panel, choose a value from the pop-up menu on the right side of the option. For options with numeric values, you can also use the up and down arrows to set the value, or you can edit the value directly in the text box. When you edit a value directly, press Enter or Return to apply a value, Shift+Enter or Shift+Return to apply a value and then highlight the value just edited, or Tab to apply a value and move to the next text box in the panel.

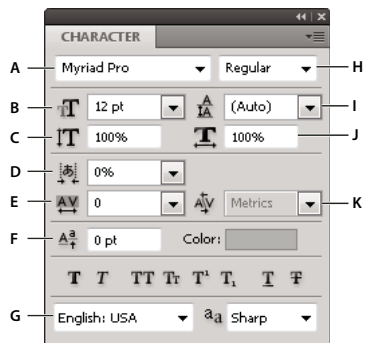

Character panel

A. Font Family B. Font Size C. Vertical Scale D. Set Tsume option E. Tracking F. Baseline Shift G. Language H. Font Style I. Leading J. Horizontal scale K. Kerning

Note: You must select Show Asian Text Options in the Type preferences for the Set Tsume option to appear in the Character panel.

You can access additional commands and options in the Character panel menu. To use this menu, click the triangle in the upper right corner of the panel.

See also

“Panels and menus” on page 14

About Dynamic Shortcuts

Dynamic Shortcuts are keyboard shortcuts that are accessible only when you are entering point or paragraph type, when type is selected, or when the I-beam is in text. You can view Dynamic Shortcuts in the Character panel menu when they are accessible. Dynamic Shortcuts are available for type options such as Faux Bold, Faux Italic, All Caps, Small Caps, Superscript, Subscript, Underline, and Strikethrough.

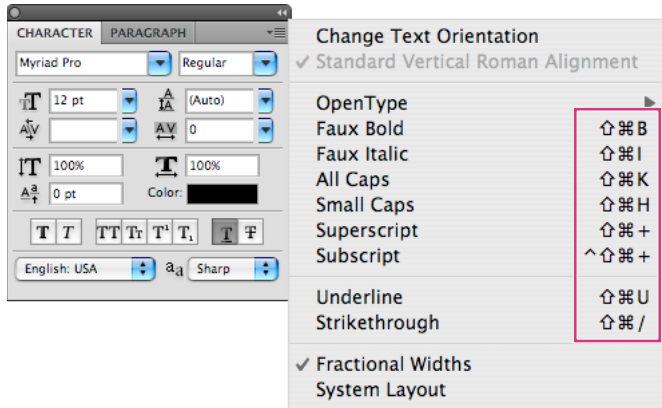

Dynamic shortcuts appear in the Character panel menu only when you are entering point or paragraph type, when type is selected, or when the I-beam is in text.

Specify type size

The *type size* determines how large the type appears in the image.

The default unit of measurement for type is *points*. One PostScript point is equal to 1/72 of an inch in a 72-ppi image; however, you can switch between using the PostScript and traditional definitions of point size. You can change the default unit of measurement for type in the Units & Rulers area of the Preferences dialog box.

Choose a type size

❖ In the Character panel or options bar, enter or select a new value for Size .

To use an alternate unit of measurement, enter the unit (in, cm, mm, pt, px, or pica) after the value in the Font Size text box.

 To change the unit of measurement for type, choose *Edit > Preferences > Units & Rulers (Windows) or Photoshop > Preferences > Units & Rulers (Mac OS)*, and choose a unit of measurement from the *Type* menu.

Define the point size unit

1 Choose *Edit > Preferences > Units & Rulers (Windows) or Photoshop > Preferences > Units & Rulers (Mac OS)*.

2 For *Point/Pica Size*, select from the following options:

PostScript (72 points/inch) Sets a unit size compatible for printing to a PostScript device.

Traditional 72.27 points/inch (Uses 72.27 points per inch, as traditionally used in printing.)

3 Click *OK*.

Change the type color

The type you enter is rendered in the current foreground color; however, you can change the color before or after you enter type. When editing existing type layers, you can change the color of individual, selected characters or of all type in a layer.

- ❖ Do one of the following:
 - Click the Color selection box in the options bar or Character panel, and select a color using the Adobe Color Picker.
 - Use fill shortcuts. To fill with the foreground color, press Alt+Backspace (Windows) or Option+Delete (Mac OS); to fill with the background color, press Ctrl+Backspace (Windows) or Command+Delete (Mac OS).
 - Apply an overlay layer style to the type layer to apply a color, gradient, or pattern on top of the existing color. You can't apply an overlay layer style selectively; it affects all characters in the type layer.
 - Click the foreground color selection box in the toolbox, and select a color using the Adobe Color Picker. Alternatively, click a color in the Color panel, or the Swatches panel. If you use this method to change the color of an existing type layer, you must first select characters on that layer.

See also

[“About layer effects and styles”](#) on page 298

Change the color of individual letters

- 1 Select the Horizontal Type tool **T**.
- 2 In the Layers panel, select the layer containing the type.
- 3 In the document window, select the characters you want to change.
- 4 In the options bar at the top of the work area, click the color swatch.
- 5 In the Adobe Color Picker, locate the color range you want using the triangle sliders on the color spectrum bar, and then click the desired color in the color field. The color you select appears in the top half of the color swatch in the Adobe Color Picker. The original color remains in the bottom half.
- 6 Click OK. The new color replaces the original color in the options bar and in the selected characters.

Note: You won't see the new color in the characters until you deselect them or select something else.

See also

[“Entering type”](#) on page 405

[“About character formatting”](#) on page 411

Underline or strike through text

You can place a line under horizontal type, or to the left or right of vertical type. You can also place a line through horizontal or vertical type. The line is always the same color as the type color.

- ❖ Select the type you want to underline or strike through.
 - To underline horizontal type, click the Underline button **T** in the Character panel.
 - To apply an underline to the left or right of vertical type, choose Underline Left or Underline Right from the Character panel menu. You can apply an underline to the left or right, but not to both sides. A check mark indicates that an option is selected.

Note: The *Underline Left* and *Underline Right* options appear in the Character panel menu only when a type layer containing vertical type is selected. When working with vertical Asian type, you can add an underline on either side of the type line.



- To apply a horizontal line through horizontal type or a vertical line through vertical type, click the Strikethrough button  in the Character panel. You can also choose Strikethrough from the Character panel menu.

Apply all caps or small caps

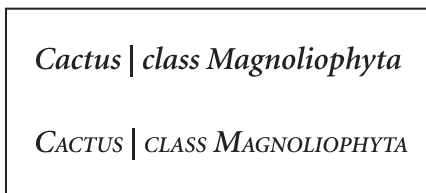
You can enter or format type as uppercase characters, either all caps or small caps. When you format text as small caps, Photoshop automatically uses the small-cap characters designed as part of the font, if available. If the font does not include small caps, Photoshop generates faux small caps.





Regular capital letters (top) compared to small-cap letters (bottom)

- 1 Select the type you want to change.
- 2 Do one of the following:
 - Click the All Caps button  or the Small Caps button  in the Character panel.
 - Choose All Caps or Small Caps from the Character panel menu. A check mark indicates that the option is selected.

Specify superscript or subscript characters

Superscript and *subscript* text (also called *superior* and *inferior* text) is reduced-size text that is raised or lowered in relation to a font's baseline. If the font does not include superscript or subscript characters, Photoshop generates faux superscript or subscript characters.

- 1 Select the type you want to change.
- 2 Do one of the following:
 - Click the Superscript button  or the Subscript button  in the Character panel.
 - Choose Superscript or Subscript from the Character panel menu. A check mark indicates that the option is selected.

Fonts

About fonts

A *font* is a complete set of characters—letters, numbers, and symbols—that share a common weight, width, and style, such as 10-pt Adobe Garamond Bold.

Typefaces (often called *type families* or *font families*) are collections of fonts that share an overall appearance, and are designed to be used together, such as Adobe Garamond.

A *type style* is a variant version of an individual font in a font family. Typically, the *Roman* or *Plain* (the actual name varies from family to family) member of a font family is the base font, which may include type styles such as regular, bold, semibold, italic, and bold italic. If a font doesn't include the style you want, you can apply *faux* styles—simulated versions of bold, italic, superscript, subscript, all caps, and small caps styles.

Typefaces include many characters in addition to the ones you see on your keyboard. Depending on the font, these characters can include ligatures, fractions, swashes, ornaments, ordinals, titling and stylistic alternates, superior and inferior characters, old-style figures, and lining figures. A *glyph* is a specific form of a character. For example, in certain fonts, the capital letter A is available in several forms, such as swash and small cap.

In addition to the fonts installed on your system, you can also use the fonts installed in these folders:

Windows Program Files/Common Files/Adobe/Fonts

Mac OS Library/Application Support/Adobe/Fonts

If you install a Type 1, TrueType, OpenType, or CID font into the local Fonts folder, the font appears in Adobe applications only.





See also

[“OpenType fonts”](#) on page 418

[“About missing fonts and glyph protection”](#) on page 417

Previewing fonts

You can view samples of a font in the font family and font style menus in the Character panel and other areas in the application from where you can choose fonts. The following icons are used to indicate different kinds of fonts:

- OpenType 
- Type 1 
- TrueType 
- Multiple Master 

You can turn off the preview feature or change the point size of the font names in Type preferences.

Choose a font family and style

- 1 Choose a font family from the Font Family menu in the Character panel or options bar. If more than one copy of a font is installed on your computer, an abbreviation follows the font name: (T1) for Type 1 fonts, (TT) for TrueType fonts, or (OT) for OpenType fonts.

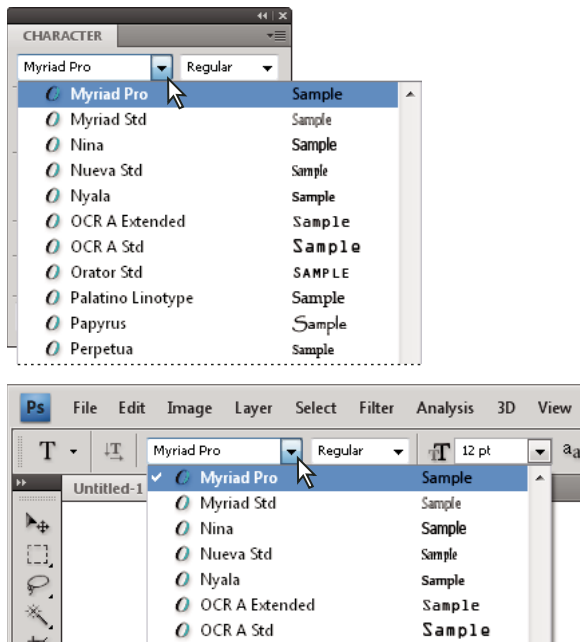

The Font Family menu in both the Character panel and the options bar shows a preview of available fonts.

 You can choose a font family and style by typing its name in the text box. As you type, the name of the first font or style beginning with that letter appears. Continue typing until the correct font or style name appears.

2 To choose a font style, do one of the following:

- Choose a font style from the Font Style menu in the Character panel or options bar.
- If the font family you chose does not include a bold or italic style, click the Faux Bold button **T** or the Faux Italic button *T* in the Character panel to apply a simulated style. Alternatively, choose Faux Bold or Faux Italic from the Character panel menu.
- Use a dynamic shortcut. Dynamic shortcuts are keyboard shortcuts that are available (in edit mode only) for Faux Bold, Faux Italic, All Caps, Small Caps, Superscript, Subscript, Underline, and Strikethrough.

Note: You cannot apply Faux Bold formatting to warped type.

Change the font on multiple layers

- 1 In the Layers panel, select the text layers you want to change.
- 2 In the Character panel, select type characteristics from the pop-up menus.



About missing fonts and glyph protection

If a document uses fonts not installed on your system, you see an alert message when you open it. Photoshop indicates which fonts are missing and substitutes missing fonts with available matching fonts. When this happens, you can select the text and apply any other available font.

Glyph protection protects against incorrect, unreadable characters that appear if you enter non-roman text (for example, Japanese or Cyrillic) after selecting a roman font. By default, Photoshop provides glyph protection by automatically selecting an appropriate font. To disable glyph protection, deselect Enable Missing Glyph Protection in the Type preferences.

OpenType fonts

OpenType fonts use a single font file for both Windows® and Macintosh® computers, so you can move files from one platform to another without worrying about font substitution and other problems that cause text to reflow. They may include a number of features, such as swashes and discretionary ligatures, that aren't available in current PostScript and TrueType fonts.

 OpenType fonts display the  icon.

When working with an OpenType font, you can automatically substitute alternate glyphs, such as ligatures, small capitals, fractions, and old style proportional figures, in your text.

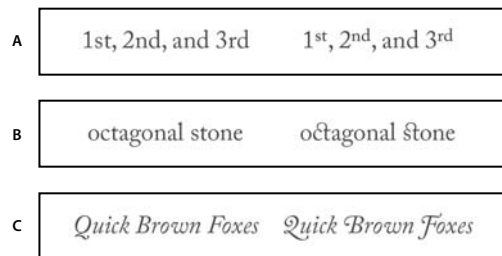

Regular (left) and OpenType (right) fonts
A. Ordinals B. Discretionary ligatures C. Swashes

OpenType fonts may include an expanded character set and layout features to provide richer linguistic support and advanced typographic control. OpenType fonts from Adobe that include support for central European (CE) languages include the word “Pro,” as part of the font name in application font menus. OpenType fonts that don't contain central European language support are labeled “Standard,” and have an “Std” suffix. All OpenType fonts can also be installed and used alongside PostScript Type 1 and TrueType fonts.

For more information on OpenType fonts, see www.adobe.com/go/opentype.

Apply OpenType features

- 1 Make sure you have an OpenType font chosen when using the Type tool. If you don't select any text, the setting applies to new text you create.
- 2 From the Character panel menu, choose one of the following from the OpenType submenu:

Standard Ligatures Are typographic replacements for certain pairs of characters, such as fi, fl, ff, ffi, and ffl.

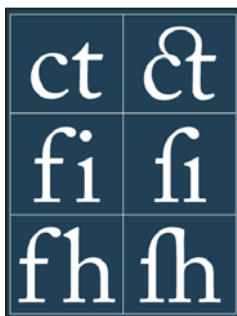

Type with the Standard Ligatures and Discretionary Ligatures options unselected and selected

Contextual Alternates Are alternative characters included in some script typefaces to provide better joining behavior. For example, when using Caflisch Script Pro with contextual alternatives enabled, the letter pair “bl” in the word “bloom” is joined so that it looks more like handwriting.

Discretionary Ligatures Are typographic replacement characters for letter pairs, such as ct, st, and ft.

Note: Although the characters in ligatures appear to be joined, they are fully editable and do not cause the spelling checker to flag a word erroneously.

Swash Substitutes *swash glyphs*, stylized letterforms with extended strokes (exaggerated flourishes).

Old Style Are numerals shorter than regular numerals, with some old style numerals descending below the type baseline.

Stylistic Alternates Formats stylized characters that create a purely aesthetic effect.

Titling Alternatives Formats characters (usually all in capitals) designed for use in large-size settings, such as titles.

Ornaments Are devices that add a personal signature to the type family and can be used as title page decoration, paragraph markers, dividers for blocks of text, or as repeated bands and borders.

Ordinals Automatically formats ordinal numbers (such as 1st and 2nd) with superscript characters. Characters such as the superscript in the Spanish words *segunda* and *segundo* (2^a and 2^o) are also typeset properly.

Fractions Automatically formats fractions; numbers separated by a slash (such as 1/2) are converted to a shilling fraction (such as ½).

 You can't preview OpenType features, such as contextual alternates, ligatures, and glyphs in Photoshop before you apply them. However, you can preview and apply OpenType features by using the Adobe Illustrator Glyphs panel. Copy and paste your text into Adobe Illustrator and use the Glyphs panel to preview and apply OpenType features. You can then paste the text back into Photoshop.

For a tutorial on viewing glyphs in Adobe Illustrator, see www.adobe.com/go/learn_ps_viewglyphsai.

See also

“Set Asian OpenType font attributes” on page 436

Line and character spacing

Set leading

The vertical space between lines of type is called *leading* (rhymes with *sledding*). For Roman type, leading is measured from the baseline of one line of text to the baseline of the line above it. The *baseline* is the invisible line on which most letters sit. You can apply more than one leading amount within the same paragraph; however, the largest leading value in a line of type determines the leading value for that line.

Note: When working with horizontal Asian type, you can specify how leading is measured, either from baseline to baseline or from the top of one line to the top of the next.

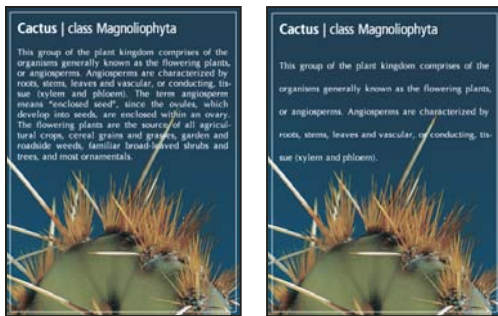

Five-point type with 6-point leading (left) and with 12-point leading (right)

See also

“[About Asian type](#)” on page 434

Set the leading

- 1 Select the characters you want to change. If you don't select any text, the leading applies to new text you create.
- 2 In the Character panel, set the Leading value.

Change the default auto leading percentage

- 1 Choose Justification from the Paragraph panel menu.
- 2 For Auto Leading, enter a new default percentage.

Kern and track

Kerning is the process of adding or subtracting space between specific pairs of characters. *Tracking* is the process of loosening or tightening the spacing between the characters in selected text or an entire block of text.

You can automatically kern type using metrics kerning or optical kerning. *Metrics kerning* (also called *Auto kerning*) uses kern pairs, which are included with most fonts. Kern pairs contain information about the spacing of specific pairs of letters. Some of these are: LA, P., To, Tr, Ta, Tu, Te, Ty, Wa, WA, We, Wo, Ya, and Yo. Metrics kerning is set as the default so that specific pairs are automatically kerned when you import or type text.

Some fonts include robust kern-pair specifications. However, when a font includes only minimal built-in kerning or none at all, or if you use two different typefaces or sizes in one or more words on a line, you may want to use the *optical kerning* option. Optical kerning adjusts the spacing between adjacent characters based on their shapes.

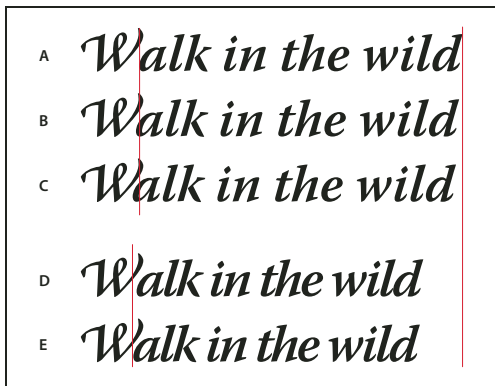

Kerning and tracking options

A. Original text B. Text with optical kerning C. Text with manual kerning between W and a D. Text with tracking E. Cumulative kerning and tracking

You can also use *manual kerning*, which is ideal for adjusting the space between two letters. Tracking and manual kerning are cumulative, so you can first adjust individual pairs of letters, and then tighten or loosen a block of text without affecting the relative kerning of the letter pairs.

When you click to place the insertion point between two letters, kerning values appear in the Character panel. Similarly, if you select a word or a range of text, the tracking values appear in the Character panel.

Tracking and kerning are both measured in 1/1000 em, a unit of measure that is relative to the current type size. In a 6-point font, 1 em equals 6 points; in a 10-point font, 1 em equals 10 points. Kerning and tracking are strictly proportional to the current type size.

Note: Values for kerning and tracking affect Japanese text, but normally these options are used to adjust the *aki* between roman characters.

Adjust kerning

❖ Do any of the following:

- To use a font's built-in kerning information for selected characters, select Metrics for the Kerning option in the Character panel.
- To automatically adjust the spacing between selected characters based on their shapes, select Optical for the Kerning option in the Character panel.
- To adjust kerning manually, place an insertion point between two characters, and set the desired value for the Kerning option in the Character panel. (Note that if a range of text is selected, you can't manually kern the text. Instead, use tracking.)

💡 Press *Alt+Left/Right Arrow (Windows)* or *Option+Left/Right Arrow (Mac OS)* to decrease or increase the kerning between two characters.

- To turn off kerning for selected characters, set the Kerning option in the Character panel to 0 (zero).

Adjust tracking

- 1 Select the range of characters or the type object that you want to adjust.
- 2 In the Character panel, set the Tracking option.

Shift the baseline

Use Baseline Shift to move selected characters up or down relative to the baseline of the surrounding text. Shifting the baseline is especially useful when you're hand-setting fractions or adjusting the position of a picture font.

- 1 Select the characters or type objects you want to change. If you don't select any text, the shift applies to new text you create.
- 2 In the Character panel, set the Baseline Shift option. Positive values move the character's baseline above the baseline of the rest of the line; negative values move it below the baseline.

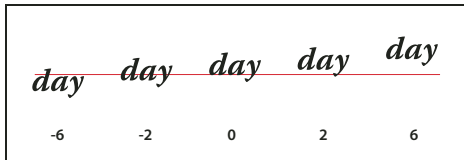

Type with different Baseline Shift values

Turn fractional character widths off or on

By default, the software uses *fractional character widths* between characters. This means that the spacing between characters varies, and will sometimes use only fractions of whole pixels.

In most situations, fractional character widths provide the best spacing for type appearance and readability. However, for type in small sizes (less than 20 points) displayed online, fractional character widths could cause type to run together or have too much extra space, making it difficult to read.

Turn off fractional widths when you want to fix type spacing in whole-pixel increments and prevent small type from running together. The fractional character width setting applies to all characters on a type layer—you cannot set the option for selected characters.

- ❖ Do any of the following:
 - To set type spacing for the entire document in whole-pixel increments, choose System Layout from the Character panel menu.
 - To re-enable fractional character widths, choose Fractional Widths from the Character panel menu.

Scaling and rotating type

Adjust the scale of type

You can specify the proportion between the height and width of the type, relative to the original width and height of the characters. Unscaled characters have a value of 100%. Some type families include a true *expanded font*, which is designed with a larger horizontal spread than the plain type style. Scaling distorts the type, so it is generally preferable to use a font that is designed as condensed or expanded, if one is available.

- 1 Select the characters or type objects you want to change. If you don't select any text, the scale applies to new text you create.
- 2 In the Character panel, set the Vertical Scaling option **!T** or the Horizontal Scaling option **T**.

Rotate type

- ❖ Do the following:
 - To rotate type, select the type layer and use any rotate command or the Free Transform command. For paragraph type, you can also select the bounding box and use a handle to rotate the type manually.
 - To rotate multiple characters in vertical Asian text, use the `tate-chu-yoko`.

See also

“Use `tate-chu-yoko`” on page 435

“Apply transformations” on page 214

Rotate vertical type characters

When working with vertical type, you can rotate the direction of characters by 90°. Rotated characters appear upright; unrotated characters appear sideways (perpendicular to the type line).

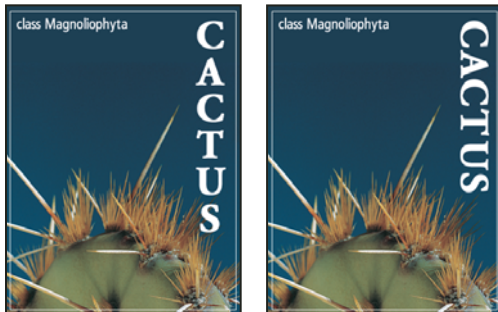

Original type (left) and type without vertical rotation (right)

- 1 Select the vertical type you want to rotate or unrotate.
- 2 Choose Standard Vertical Roman Alignment from the Character panel menu. A check mark indicates that the option is selected.

Note: You cannot rotate double-byte characters (full-width characters available only in Chinese, Japanese, and Korean fonts). Any double-byte characters in the selected range will not be rotated.

Formatting paragraphs

Format paragraphs

For point type, each line is a separate paragraph. For paragraph type, each paragraph can have multiple lines, depending on the dimensions of the bounding box.

You can select paragraphs and then use the Paragraph panel to set formatting options for a single paragraph, multiple paragraphs, or all paragraphs in a type layer.

- ❖ Select the Horizontal Type tool **T** or the Vertical Type tool **↓T**.
 - To apply formatting to a single paragraph, click in a paragraph.
 - To apply formatting to multiple paragraphs, make a selection within a range of paragraphs.

- To apply formatting to all paragraphs in the layer, select the type layer in the Layers panel.

See also

“[Formatting characters](#)” on page 411

“[Line and character spacing](#)” on page 419

“[Scaling and rotating type](#)” on page 422

“[Editing text](#)” on page 407

Paragraph panel overview

You use the Paragraph panel to change the formatting of columns and paragraphs. To display the panel, choose Window > Paragraph, or click the Paragraph panel tab if the panel is visible but not active. You can also select a type tool and click the Panel button  in the options bar.

To set options with numeric values in the Paragraph panel, you can use the up and down arrows or edit the value directly in the text box. When you edit a value directly, press Enter or Return to apply a value, Shift+Enter or Shift+Return to apply a value and then highlight the value just edited, or Tab to apply a value and move to the next text box in the panel.

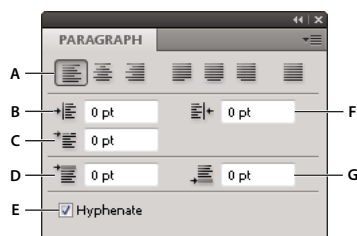

Paragraph panel

A. Alignment and justification B. Left indent C. First line left indent D. Space before paragraph E. Hyphenation F. Right indent G. Space after paragraph

You can access additional commands and options in the Paragraph panel menu. To use this menu, click the triangle in the upper right corner of the panel.

Specify alignment

You can *align* type to one edge of a paragraph (left, center, or right for horizontal type; top, center, or bottom for vertical type). Alignment options are available only for paragraph type.

1 Do one of the following:

- Select a type layer if you want all the paragraphs in that type layer to be affected.
- Select the paragraphs you want affected.

2 In the Paragraph panel or options bar, click an alignment option.

The options for horizontal type are:

Left Align Text Aligns type to the left, leaving the right edge of the paragraph ragged.

Center Text Aligns type to the center, leaving both edges of the paragraph ragged.

Right Align Text Aligns type to right, leaving the left edge of the paragraph ragged.

The options for vertical type are:

Top Align Text Aligns type to the top, leaving the bottom edge of the paragraph ragged.

Center Text Aligns type to the center, leaving both the top and bottom edges of the paragraph ragged.

Bottom Align Text Aligns type to the bottom, leaving the top edge of the paragraph ragged.

Specify justification for paragraph type

Text is said to be *justified* when it is aligned with both edges. You can choose to justify all text in a paragraph excluding the last line, or you can justify text in a paragraph including the last line. The settings you choose for justification affect the horizontal spacing of lines and the aesthetic appeal of type on a page. Justification options are available only for paragraph type and determine word, letter, and glyph spacing. Justification settings apply only to Roman characters; double-byte characters available in Chinese, Japanese, and Korean fonts are not affected by these settings.

1 Do one of the following:

- Select a type layer if you want all the paragraphs in that type layer to be affected.
- Select the paragraphs you want affected.

2 In the Paragraph panel, click a justification option.

The options for horizontal type are:

Justify Last Left Justifies all lines except the last, which is left aligned.

Justify Last Centered Justifies all lines except the last, which is center aligned.

Justify Last Right Justifies all lines except the last, which is right aligned.

Justify All Justifies all lines including the last, which is force justified.

The options for vertical type are:

Justify Last Top Justifies all lines except the last, which is top aligned.

Justify Last Centered Justifies all lines except the last, which is center aligned.

Justify Last Bottom Justifies all lines except the last, which is bottom justified.

Justify All Justifies all lines including the last, which is force justified.

Note: Justification (right, center, and left align, and justify all) for type on a path starts at the insertion point and ends at the end of the path.

Adjust word and letter spacing in justified text

You can precisely control how Photoshop spaces letters and words and scales characters. Adjusting spacing is especially useful with justified type, although you can also adjust spacing for unjustified type.

- 1 Select the paragraphs you want affected, or select a type layer if you want all the paragraphs in that type layer to be affected.
- 2 Choose Justification from the Paragraph panel menu.
- 3 Enter values for Word Spacing, Letter Spacing, and Glyph Spacing. The Minimum and Maximum values define a range of acceptable spacing for justified paragraphs only. The Desired value defines the desired spacing for both justified and unjustified paragraphs:

Word Spacing The space between words that results from pressing the spacebar. Word Spacing values can range from 0% to 1000%; at 100%, no additional space is added between words.

Letter Spacing The distance between letters, including kerning or tracking values. Letter Spacing values can range from -100% to 500%; at 0%, no space is added between letters; at 100% , an entire space width is added between letters.

Glyph Spacing The width of characters (a *glyph* is any font character). Glyph Spacing values can range from 50% to 200%; at 100%, the height of characters is not scaled.

 *Spacing options are always applied to an entire paragraph. To adjust the spacing in a few characters, but not an entire paragraph, use the Tracking option.*

See also

“[Set leading](#)” on page 419

Indent paragraphs

Indentation specifies the amount of space between type and the bounding box or line that contains the type. Indentation affects only the selected paragraph or paragraphs, so you can easily set different indentions for paragraphs.

1 Do one of the following:

- Select a type layer if you want all the paragraphs in that type layer to be affected.
- Select the paragraphs you want affected.



2 In the Paragraph panel, enter a value for an indentation option:

Indent Left Margin Indents from the left edge of the paragraph. For vertical type, this option controls the indentation from the top of the paragraph.

Indent Right Margin Indents from the right edge of the paragraph. For vertical type, this option controls the indentation from the bottom of the paragraph.

Indent First Line Indents the first line of type in the paragraph. For horizontal type, the first line indent is relative to the left indent; for vertical type, the first line indent is relative to the top indent. To create a first line hanging indent, enter a negative value.

Adjust paragraph spacing

- 1 Select the paragraphs you want affected, or select a type layer if you want all the paragraphs in that type layer to be affected. If you don't insert the cursor in a paragraph or select a type layer, the setting applies to new text you create.
- 2 In the Paragraph panel, adjust the values for Add Space Before Paragraph  and Add Space After Paragraph .

See also

“[Set leading](#)” on page 419

Specify hanging punctuation for Roman fonts

Hanging punctuation controls the alignment of punctuation marks for a specific paragraph. When Roman Hanging Punctuation is turned on, the following characters appear outside the margins: single quotes, double quotes, apostrophes, commas, periods, hyphens, em dashes, en dashes, colons, and semicolons. When a punctuation character is followed a quotation mark, both characters hang.

Keep in mind that the paragraph alignment determines the margin from which the punctuation hangs. For left-aligned and right-aligned paragraphs, punctuation hangs off the left and right margin, respectively. For top-aligned and bottom-aligned paragraphs, punctuation hangs off the top and bottom margin, respectively. For centered and justified paragraphs, punctuation hangs off both margins.

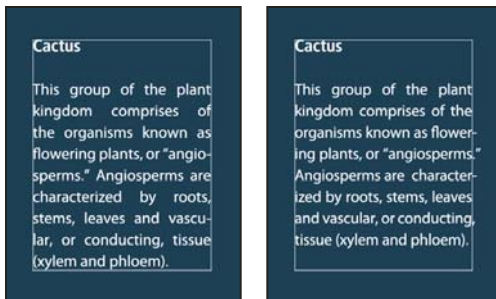

Paragraph without hanging punctuation (left) compared to paragraph with hanging punctuation (right)

- 1 Do one of the following:
 - Select a type layer if you want all the paragraphs in that type layer to be affected.
 - Select the paragraphs you want affected.
- 2 Choose Roman Hanging Punctuation from the Paragraph panel menu. A check mark indicates that the option is selected.

Note: Double-byte punctuation marks available in Chinese, Japanese, and Korean fonts in the selected range will not hang when you use Roman Hanging Punctuation. Instead, use either Burasagari Standard or Burasagari Strong. These items are available only if you select Show Asian Text Options in the Type preferences.

See also

[“Specify a burasagari option”](#) on page 439

[“Display and set Asian type options”](#) on page 434

Adjust hyphenation automatically

The settings you choose for hyphenation affect the horizontal spacing of lines and the aesthetic appeal of type on a page. Hyphenation options determine whether words can be hyphenated and, if so, what breaks are allowable.

- 1 To use automatic hyphenation, do any of the following:
 - To turn automatic hyphenation on or off, select or deselect the Hyphenate option in the Paragraph panel.
 - To apply hyphenation to specific paragraphs, first select only the paragraphs that you want to affect.
 - To choose a hyphenation dictionary, choose a language from the Language menu at the bottom of the Character panel.
- 2 To specify options, choose Hyphenation from the Paragraph panel menu, and specify the following options:

Words Longer Than _ Letters Specifies the minimum number of characters for hyphenated words.

After First _ Letters And Before Last _ Letters Specifies the minimum number of characters at the beginning or end of a word that can be broken by a hyphen. For example, by specifying 3 for these values, **aromatic** would be hyphenated as **aro- matic** instead of **ar- omatic** or **aromat- ic**.

Hyphen Limit Specifies the maximum number of consecutive lines on which hyphenation may occur.

Hyphenation Zone Specifies a distance from the right edge of a paragraph, demarcating a portion of the line where hyphenation is not allowed. A setting of 0 allows all hyphenation. This option applies only when you use the Adobe Single-line Composer.

Hyphenate Capitalized Words Select to prevent capitalized words from being hyphenated.

Note: Hyphenation settings apply only to Roman characters; double-byte characters available in Chinese, Japanese, and Korean fonts are not affected by these settings.

Prevent words from breaking

You can prevent words from breaking at the end of lines—for example, proper names or words that could be misread when hyphenated. You can also keep multiple words or groups of words together—for example, clusters of initials and a last name.

- 1 Select the characters you want to prevent from breaking.
- 2 Choose No Break from the Character panel menu.

Note: If you apply the No Break option to too many adjacent characters, the text may wrap in the middle of a word. However, if you apply the No Break option to more than a single line of text, none of the text will appear.

Composition methods

The appearance of type on the page depends on a complex interaction of processes called *composition*. Using the word spacing, letterspacing, glyph spacing, and hyphenation options you've selected, Adobe applications evaluate possible line breaks and choose the one that best supports the specified parameters.

You can choose between two composition methods: the Adobe Every-line Composer and the Adobe Single-line Composer. Both methods evaluate possible breaks and choose the one that best supports the hyphenation and justification options you've specified for a given paragraph. The composition method affects only the selected paragraph or paragraphs, so you can easily set different composition methods for different paragraphs.

Every-line Composer

The Every-line Composer considers a network of break points for a range of lines and thus can optimize earlier lines in the paragraph in order to eliminate especially unattractive breaks later on.

The Every-line Composer approaches composition by identifying possible break points, evaluating them, and assigning a weighted penalty based on the following principles:

- For left-, right-, or center-aligned text, lines that fall closer to the right side are favored and have a lower penalty.
- For justified text, the highest importance is given to evenness of letter and word spacing.
- Hyphenation is avoided when possible.

Single-line Composer

The Single-line composer offers a traditional approach to composing type one line at a time. This option is useful if you want manual control over how lines break. The Single-line Composer uses the following principles when considering a breakpoint:

- Longer lines are favored over shorter lines.
- In justified text, compressed or expanded word spacing is preferable to hyphenation.
- In nonjustified text, hyphenation is preferable to compressed or expanded letterspacing.
- If spacing must be adjusted, compression is better than expansion.

To choose one of these methods, select it from the Paragraph panel menu. To apply the method to all paragraphs, first select the type object; to apply the method to the current paragraph only, first insert the cursor in that paragraph.

Creating type effects

About type effects

You can perform various operations on type to change its appearance. For example, you can warp type, convert type to shapes, or add a drop shadow to type. One of the easiest ways to create type effects is to play the default Text Effects actions that come with Photoshop on a type layer. You can access these effects by choosing Text Effects from the Actions panel menu.

See also

[“Play an action on a file”](#) on page 615

Create and edit type on a path

You can enter type that flows along the edge of a work path created by a pen or a shape tool.

When you enter type along a path, the type flows in the direction that anchor points were added to the path. Entering horizontal type on a path results in letters that are perpendicular to the baseline. Entering vertical type on a path results in text orientation parallel to the baseline.

As you move a path or change its shape, the type conforms to the new path location or shape.

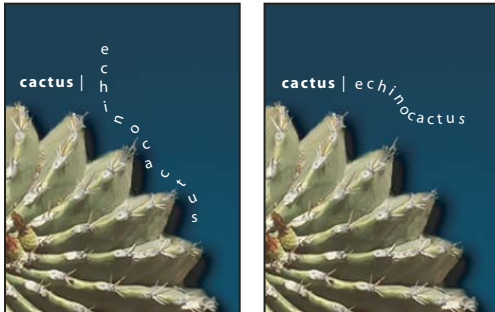

Horizontal and vertical type on an open path.

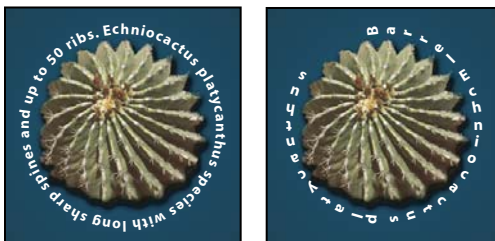

Horizontal and vertical type on a closed path created by a shape tool

See also

[“Drawing shapes and paths”](#) on page 359

[“Shift the baseline”](#) on page 422

Enter type along a path

- 1 Do one of the following:
 - Select the Horizontal Type tool **T** or the Vertical Type tool **⌫T**.
 - Select the Horizontal Type Mask tool **⌫T** or the Vertical Type Mask tool **⌫⌫T**.
- 2 Position the pointer so that the baseline indicator of the type tool **⌫** is on the path and click. After you click, an insertion point appears on the path.

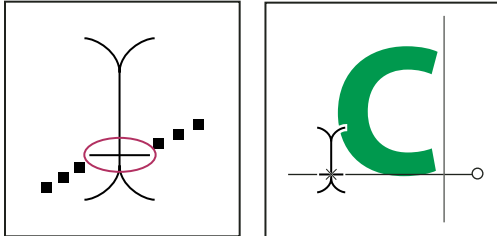

The baseline indicator of the Type tool (left) and the Type tool with its baseline indicator on a path (right)

- 3 Enter the type. Horizontal type appears along the path, perpendicular to the baseline. Vertical type appears along the path, parallel to the baseline.

 For more control over vertical alignment of type on a path, use the Baseline Shift option in the Character panel. For example, type a negative value in the Baseline Shift text box to lower the type.

Move or flip type on a path

- ❖ Select the Direct Selection tool **A** or Path Selection tool **A** and position it over the type. The pointer changes to an I-beam with an arrow **⌫**.
- To move text, click and drag the type along the path. Be careful not to drag across the path.
- To flip text to the other side of the path, click and drag the type across the path.

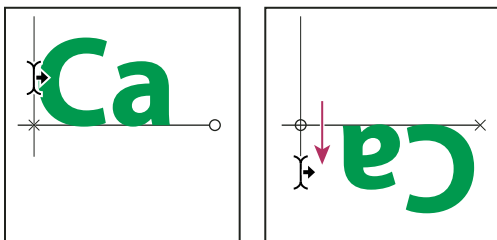

Using the Direct Selection tool or Path Selection tool to move or flip type on a path.

 To move type across a path without changing the direction of the type, use the Baseline Shift option in the Character panel. For example, if you created type that runs from left to right across the top of a circle, you can enter a negative number in the Baseline Shift text box to drop the type so that it flows inside the top of the circle.

Move a path with type

- ❖ Select the Path Selection tool **A** or the Move tool **V**, and then click and drag the path to a new position. If you use the Path Selection tool, make sure that the pointer does not change to an I-beam with an arrow **⌫** or you'll move the type along the path.

Change the shape of a path with type

- 1 Select the Direct Selection tool **A**.

- 2 Click an anchor point on the path and use the handles to change the shape of the path.

Warp and unwarped type

You can warp type to create a special type effect. For example, you can warp type in the shape of an arc or a wave. The warp style you select is an attribute of the type layer—you can change a layer's warp style at any time to change the overall shape of the warp. Warping options give you precise control over the orientation and perspective of the warp effect.

Note: You cannot warp type layers that include Faux Bold formatting or that use fonts without outline data (such as bitmap fonts).

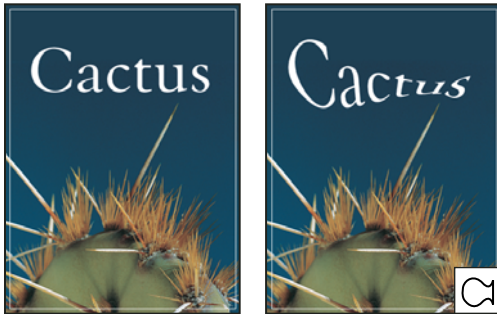

Example of type warped with Fish style.

See also

“Warp an item” on page 219

Warp type

- 1 Select a type layer.
- 2 Do one of the following:
 - Select a type tool, and click the Warp button  in the options bar.
 - Choose Layer > Type > Warp Text.

Note: You can use the Warp command to warp text in a type layer. Choose Edit > Transform Path > Warp.

- 3 Choose a warp style from the Style pop-up menu.
- 4 Select the orientation of the warp effect—Horizontal or Vertical.
- 5 If desired, specify values for additional warping options:
 - Bend to specify how much warp is applied to the layer
 - Horizontal Distortion or Vertical Distortion to apply perspective to the warp

Unwarp type

- 1 Select a type layer that has warping applied to it.
- 2 Select a type tool and click the Warp button  in the options bar, or choose Layer > Type > Warp Text.
- 3 Choose None from the Style pop-up menu, and click OK.

Create a work path from type

You can work with type characters as vector shapes by converting them to a work path. A *work path* is a temporary path that appears in the Paths panel and defines the outline of a shape. After you create a work path from a type layer, you can save and manipulate it as you do any other path. You cannot edit characters in the path as text; however, the original type layer remains intact and editable.

- ❖ Select a type layer, and choose Layer > Type > Create Work Path.

Note: You cannot create work paths from fonts that don't include outline data (such as bitmap fonts).

See also

[“Path segments, components, and points”](#) on page 372

Convert type to shapes

When you convert type to shapes, the type layer is replaced by a layer with a vector mask. You can edit the vector mask and apply styles to the layer; however, you cannot edit characters in the layer as text.

- ❖ Select a type layer, and choose Layer > Type > Convert To Shape.



Note: You cannot create shapes from fonts that don't include outline data (such as bitmap fonts).

See also

[“Drawing shapes and paths”](#) on page 359

Create a type selection border

When you use the Horizontal Type Mask tool or Vertical Type Mask tool, you create a selection in the shape of the type. Type selections appear on the active layer, and can be moved, copied, filled, or stroked just like any other selection.

- 1 Select the layer on which you want the selection to appear. For best results, create the type selection border on a normal image layer, not a type layer. If you want to fill or stroke the type selection border, create it on a new blank layer.
- 2 Select the Horizontal Type Mask tool  or the Vertical Type Mask tool .
- 3 Select additional type options, and enter type at a point or in a bounding box.

A red mask appears over the active layer as you enter the type. After you click the Commit button , the type selection border appears in the image on the active layer.

Add a drop shadow to text

Add a drop shadow to give depth to text in an image.

- 1 In the Layers panel, select the layer containing the text to which you want to add a drop shadow.
- 2 Click the Layer Style button  at the bottom of the Layers panel and choose Drop Shadow from the list that appears.
- 3 If possible, position the Layer Style dialog box so that you can see the layer and its drop shadow.
- 4 Adjust the settings to your liking. You can change various aspects of the shadow, including the way it blends with the layers below it, its opacity (how much the underlying layers show through), the angle of the light, and its distance from the text or object.

- 5 When you're satisfied with the drop shadow, click OK.



 *To use the same drop shadow settings on another layer, Alt+drag the Drop Shadow layer in the Layers panel to the other layer. When you release the mouse button, Photoshop applies the drop shadow attributes to the layer.*

See also

[“About layer effects and styles”](#) on page 298

Fill type with an image

You can fill type with an image by applying a clipping mask to an image layer placed above a text layer in the Layers panel.

- 1 Open the file containing the image you want to use inside the text.
- 2 Select the Horizontal Type tool  or the Vertical Type tool  in the toolbox.
- 3 Click the Character tab to bring the Character panel to the front or, if the panel isn't open, choose Window > Character.
- 4 In the Character panel, select the font and other type attributes for the text. Large, bold, thick letters work best.
- 5 Click an insertion point in the document window and type the desired text. When you are satisfied with the text, press Ctrl+Enter (Windows) or Command+Return (Mac OS).
- 6 Click the Layers tab to bring the Layers panel to the front or, if the panel isn't open, choose Windows > Layers.
- 7 (Optional) If the image layer is the background layer, double-click the image layer in the Layers panel to convert it from a background layer into a regular layer.

***Note:** Background layers are locked and prevent you from moving them in the Layers panel. It's necessary to convert background layers to regular layers to unlock them.*

- 8 (Optional) In the New Layer dialog box, you can rename the layer. Click OK to close the dialog box and convert the image layer.
- 9 In the Layers panel, drag the image layer so that it is immediately above the text layer.
- 10 With the image layer selected, choose Layer > Create Clipping Mask. The image appears inside the text.
- 11 Select the Move tool , and then drag the image to adjust its placement within the text.

 *To move the text instead of the image, select the text layer in the Layers panel and then use the Move tool to move the text.*

See also

[“Mask layers with clipping masks”](#) on page 326

[“Entering type”](#) on page 405

[“About character formatting”](#) on page 411

Asian type

About Asian type

Photoshop provides several options for working with Chinese, Japanese, and Korean type. Characters in Asian fonts are often referred to as *double-byte characters*.

Note: Your operating system must support the languages in which you wish to work. Consult your system software manufacturer for more information.

Display and set Asian type options

By default, non-Chinese, Japanese, or Korean versions of Photoshop hide options for Asian type that appear in the Character panel and Paragraph panel. To view and set options for working with Chinese, Japanese, and Korean type in these versions of Photoshop, you must select Show Asian Text Options in the Preferences dialog box. You can also control how font names are displayed—in English or in the native language.

- 1 Choose Edit > Preferences > Type (Windows) or Photoshop > Preferences > Type (Mac OS).
- 2 Select from the following options:

Show Asian Text Options Displays Asian type options in the Character and Paragraph panels.

Show Font Names In English Displays Asian font names in English.

Reduce spacing around Asian type characters

Tsume reduces the space around a character by a specified percentage value. As a result, the character itself is not stretched or squeezed. Instead, the space between the character's bounding box and the em box is compressed. When *tsume* is added to a character, spacing around both sides of the character is reduced by an equal percentage.

- 1 Select the characters you want to adjust.
- 2 In the Character panel, enter or select a percentage for Tsume . The greater the percentage, the tighter the compression between characters. At 100% (the maximum value), there is no space between the character's bounding box and its em box.

Specify how leading is measured in Asian type

- 1 Select the paragraphs you want to adjust.
- 2 Choose a leading option from the Paragraph panel menu.

Top-to-top Leading Measures the spacing between lines of type from the top of one line to the top of the next line. When you use top-to-top leading, the first line of type in a paragraph is aligned flush with the top of the bounding box.

Bottom-to-bottom Leading For horizontal type, measures the space between lines of type from the type baseline. When you use bottom-to-bottom leading, space appears between the first line of type and the bounding box. A check mark indicates which option is selected.

Note: The leading option you choose does not affect the amount of leading between lines, only how the leading is measured.

Use tate-chu-yoko

Tate-chu-yoko (also called *kumimoji* and *renmoji*) is a block of horizontal type laid out within vertical type lines. Using *tate-chu-yoko* makes it easier to read half-width characters such as numbers, dates, and short foreign words in vertical text.

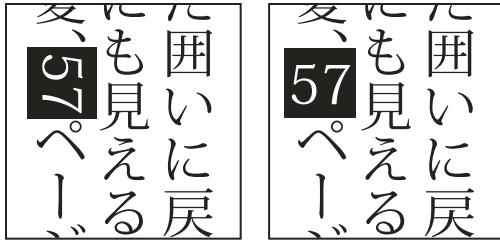

Numerals without *tate-chu-yoko* (left) compared to numerals rotated with *tate-chu-yoko* (right)

- 1 Select the characters you want to rotate.
- 2 Choose *Tate-Chu-Yoko* from the Character panel menu. A check mark indicates that the option is turned on.

Note: Using *tate-chu-yoko* does not prevent you from editing and formatting type; you can edit and apply formatting options to rotated characters just as you do to other characters.

Align Asian characters

Mojisoroe is the alignment of characters in Asian type. When a line of text contains different sizes of characters, you can specify how to align text to the largest characters in the line: to the top, center, or bottom of the em box (right, center, and left for vertical frames), to the roman baseline, or to the top or bottom of the ICF box (right or left for vertical frames). *ICF* (Ideographic Character Space) is the average height and width used by the font designer to design the ideographic characters which comprise a font.

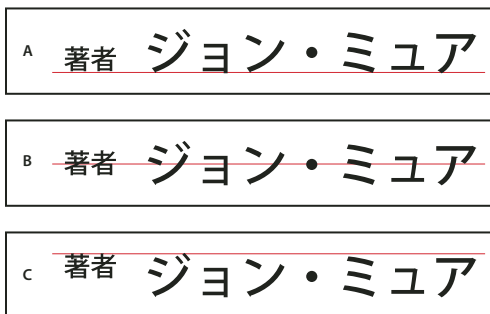

Character alignment options

A. Small characters aligned to the bottom B. Small characters aligned to the center C. Small characters aligned to the top

❖ In the Character panel menu, choose an option from the Character Alignment submenu:

Roman Baseline Aligns the small characters in a line to the large character.

Em box Top/Right, Em box Center, or Em box Bottom/Left Aligns the small characters in a line to the specified position of the large character's em box. In vertical text frames, Em box Top/Right aligns the text to the right of the em box, and Em box Bottom/Left aligns the text to the left of the em box.

ICF Top/Right and ICF Bottom/Left Aligns the small characters in a line to the ICF specified by the large characters. In vertical text frames, ICF Top/Right aligns the text to the right of the ICF, and ICF Bottom/Left aligns the text to the left of the ICF.

Specify left and right underlining with Asian type

- 1 Select vertical type.
- 2 Choose either Underline Left or Underline Right from the Character panel menu.

Set Asian OpenType font attributes

Asian OpenType fonts may include a number of features that aren't available in current PostScript and TrueType fonts. It is usually best to use any weights of KozMinPro and KozGoPro OpenType fonts. These fonts have the largest collection of glyphs of the Asian fonts produced by Adobe.

- 1 With the Type tool selected, do one of the following:
 - On an existing type layer, select the characters or type objects to which you want to apply the setting.
 - Click on the image to create a new type layer.
- 2 In the Character panel, make sure that an Asian OpenType Pro font is selected.
- 3 From the Character panel menu, choose an OpenType option.
- 4 Turn on the MSIME (Windows) or Kotoeri (Mac OS) input method. Do one of the following:
 - (Windows) From the Windows Start menu, choose Programs > Accessories > System Tools > Character Map.
 - (Mac OS) Select the Kotoeri input method by choosing Show Character Panel from the Kotoeri menu.
 - (Mac OS) From the Input pop-up menu at the right side of the menu bar, choose Show Character Panel.

Note: (Mac OS) If the Input menu does not display in the menu bar, choose Apple menu > System Preferences > International > Input Menu and select Character Panel and Show input menu in menu bar.

- 5 Do one of the following:
 - (Windows) In Character Map, select the Advanced View option, choose All from the Group By menu, and then choose Unicode for Character Set.



Character Map
A. Font menu B. Advanced View check box

- (Mac OS) In the Kotoeri Character panel, select Glyph from the View menu.

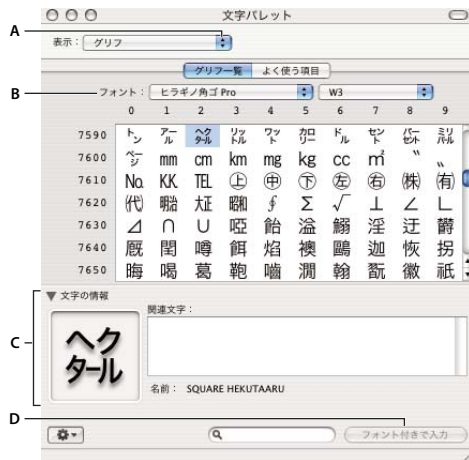

Kotoeri Character panel
A. View menu B. Font menu C. Character Information D. Insert With Font button

6 Choose an Asian OpenType font from the Font menu.

7 Do one of the following:

- (Windows) Select the character you want to use, click Select, click Copy, and then paste it in Photoshop.
- (Mac OS) Double-click the character you want to use to insert it into your document.

Asian OpenType options

Additional OpenType options are available, depending on the font.

Japanese 78 Substitutes the standard glyph with the jp78-variant glyph.

Japanese Expert Substitutes the standard glyph with the expert-variant glyphs.

Japanese Traditional Substitutes the standard glyph with the traditional-variant glyph.

Proportional Metrics Substitutes the half-width and the full-width glyphs with the proportional glyph.

Kana Substitutes the standard kana glyph with the horizontally optimized kana glyph for horizontal layout. However, the differences are often very subtle.

Roman Italics Substitutes the standard proportional glyph with the italic glyph.

See also

“[Apply OpenType features](#)” on page 418

Choose a mojikumi set

Mojikumi specifies Japanese text composition for spacing of Japanese characters, roman characters, punctuation, special characters, line start, line end, and numbers. Photoshop includes several predefined mojikumi sets based on the Japanese Industrial Standard (JIS) X 4051-1995.

❖ In the Paragraph panel, choose an option from the Mojikumi pop-up menu:

None Turns off the use of mojikumi.

Mojikumi Set 1 Uses half-width spacing for punctuation.

Mojikumi Set 2 Uses full-width spacing for most characters except the last character in the line.

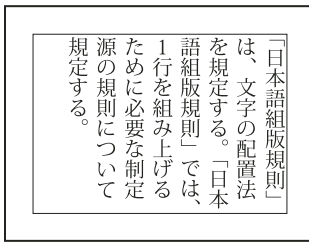
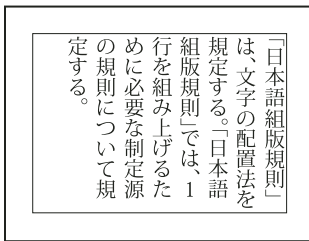

Mojikumi Set 1, and Mojikumi Set 2

Mojikumi Set 3 Uses full-width spacing for most characters and the last character in the line.

Mojikumi Set 4 Uses full-width spacing for all characters.

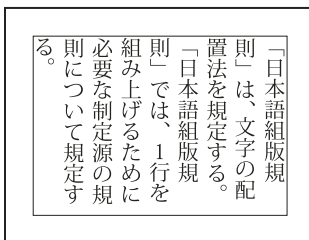
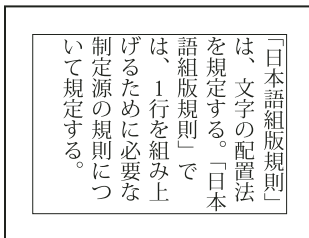

Mojikumi Set 3, and Mojikumi Set 4

Choose kinsoku shori settings for a paragraph

Kinsoku shori specifies line breaks for Japanese text. Characters that cannot begin a line or end a line are known as *kinsoku* characters. Photoshop includes weak and maximum kinsoku sets based on the Japanese Industrial Standard (JIS) X 4051-1995. Weak kinsoku sets omit long vowel symbols and small hiragana characters.

❖ In the Paragraph panel, choose an option from the Kinsoku Shori pop-up menu:

None Turns off the use of kinsoku shori.

JIS Weak or JIS Maximum Prevents the following characters from beginning or ending a line:

Chapter 15: Saving and exporting images

Adobe Photoshop CS4 supports a variety of file formats to suit a wide range of output needs. You can save or export your image to any of these formats. You can also use special Photoshop features to add information to files, set up multiple page layouts, and place images in other applications.

Saving images

Saving image files

Graphic file formats differ in the way they represent image data (as pixels or vectors), in compression techniques, and which Photoshop features they support. To preserve all the Photoshop features in your edited image (layers, effects, masks, styles, and so forth), it's best to save a copy of your image in Photoshop format (PSD). Like most file formats, PSD can only support files up to 2 GB in size. In Photoshop, if you are working with document files larger than 2 GB, you can save your image in the Large Document Format (PSB), Photoshop Raw (flattened image only), or TIFF (up to 4 GB in size only).

Note: The DICOM format also supports files larger than 2 GB.

You can save 16-bits-per-channel images only in the following formats using the Save As command: Photoshop, Photoshop PDF, Photoshop Raw, Large Document Format (PSB), Cineon, PNG, and TIFF. When using the Save For Web & Devices command with a 16-bits-per-channel image, Photoshop automatically converts the image from 16 bits per channel to 8 bits per channel.

You can save 32-bits-per-channel images only in the following formats using the Save As command: Photoshop, Large Document Format (PSB), OpenEXR, Portable bitmap, Radiance, and TIFF.

You can use the following commands to save images:

Save Saves changes you've made to the current file. The file is saved in the current format.

Save As Saves an image in a different location or under another filename. The Save As command lets you save an image in a different format and with different options.

Check In Lets you save different versions of a file and comment on each. This command is available for an image that is managed by a Version Cue Workspace.

 *If you're working with a file from an Adobe Version Cue project, the document title bar provides additional information about the status of the file.*

Save For Web & Devices Save an optimized image for the web and devices.

See also

[“About file formats and compression”](#) on page 457

Save a file

You use the Save command to save changes to the current file or Save As to save a new version of the current file.

See also

“Duplicate an image” on page 35

“Save a camera raw image in another format” on page 86

“Make a snapshot of an image” on page 49

Save changes to the current file

❖ Choose File > Save.

Save a file with a different name, location, or format

1 Choose File > Save As.

Note: The Camera Raw plug-in can save camera raw image files in a different file format, such as Digital Negative (DNG).

2 Choose a format from the Format menu.

Note: If you choose a format that does not support all the features of the document, a warning will appear at the bottom of the dialog box. If you see this warning, it's best to save a copy of the file in Photoshop format or in another format that supports all of the image data.

3 Specify a filename and location.

4 In the Save As dialog box, select saving options.

5 Click Save.

A dialog box appears for choosing options when saving in some image formats.

 To copy an image without saving it to your hard disk, use the Duplicate command. To store a temporary version of the image in memory, use the History panel to create a snapshot.

File saving options

You can set a variety of file saving options in the Save As dialog box. The availability of options depends on the image you are saving and the selected file format. If you have Version Cue enabled, additional options are available, such as the ability to save an alternate file and enter version comments.

As A Copy Saves a copy of the file while keeping the current file open on your desktop.

Alpha Channels Saves alpha channel information with the image. Disabling this option removes the alpha channels from the saved image.

Layers Preserves all layers in the image. If this option is disabled or unavailable, all visible layers are flattened or merged (depending on the selected format).

Notes Saves notes with the image.

Spot Colors Saves spot channel information with the image. Disabling this option removes spot colors from the saved image.

Use Proof Setup, ICC Profile (Windows), or Embed Color Profile (Mac OS) Creates a color-managed document.

Note: The following image preview and file extension options are available only if Ask When Saving is selected for the Image Previews and Append File Extension (Mac OS) options in the File Handling Preferences dialog box.

Thumbnail (Windows) Saves thumbnail data for the file.

Use Lower Case Extension (Windows) Makes the file extension lowercase.

Image Previews options (Mac OS) Saves thumbnail data for the file. Thumbnails appear in the Open dialog box.

File Extension options (Mac OS) Specifies the format for file extensions. Select Append to add the format's extension to a filename and Use Lower Case to make the extension lowercase.

Set file saving preferences

1 Do one of the following:

- (Windows) Choose Edit > Preferences > File Handling.
- (Mac OS) Choose Photoshop > Preferences > File Handling.

2 Set the following options:

Image Previews Choose an option for saving image previews: Never Save to save files without previews, Always Save to save files with specified previews, or Ask When Saving to assign previews on a file-by-file basis. In Mac OS, you can select one or more preview types. See “Mac OS image preview options,” below.

File Extension (Windows) Choose an option for the three-character file extensions that indicate a file's format: Use Upper Case to append file extensions using uppercase characters, or Use Lower Case to append file extensions using lowercase characters.

Append File Extension (Mac OS) File extensions are necessary for files that you want to use on or transfer to a Windows system. Choose an option for appending extensions to filenames: Never to save files without file extensions, Always to append file extensions to filenames, or Ask When Saving to append file extensions on a file-by-file basis. Select Use Lower Case to append file extensions using lowercase characters.

Mac OS image preview options

In Mac OS, you can select one or more of the following preview types (to speed the saving of files and minimize file size, select only the previews you need).

Icon Uses the preview as a file icon on the desktop.

Full Size Saves a 72-ppi version of the file for use in applications that can open only low-resolution Photoshop images. For non-EPS files, this is a PICT preview.

Macintosh Thumbnail Displays the preview in the Open dialog box.

Windows Thumbnail Saves a preview that Windows systems can display.

Save large documents

Photoshop supports documents up to 300,000 pixels in either dimension and offers three file formats for saving documents with images having more than 30,000 pixels in either dimension. Keep in mind that most other applications, including versions of Photoshop earlier than Photoshop CS, cannot handle files larger than 2 GB or images exceeding 30,000 pixels in either dimension.

❖ Choose File > Save As, and choose one of the following file formats:

Large Document Format (PSB) Supports documents of any file size. All Photoshop features are preserved in PSB files. Currently, PSB files are supported only by Photoshop CS and later.

Photoshop Raw Supports documents of any pixel dimension or file size, but does not support layers. Large documents saved in the Photoshop Raw format are flattened.

TIFF Supports files up to 4 GB in size. Documents larger than 4 GB cannot be saved in TIFF format.

See also

“[Large Document Format](#)” on page 461

“[Photoshop Raw format](#)” on page 459

“[TIFF](#)” on page 463

Testing Photoshop images for mobile devices with Adobe Device Central

Device Central enables Photoshop users to preview how Photoshop files will look on a variety of mobile devices.

Creative professionals can create Photoshop files specifically for mobile devices and easily test the files. Users can create a document in Photoshop based on a targeted device.

For example, a user interface designer might use Photoshop to create mock-ups. The designer can test the mock-ups on a variety of handsets, make necessary adjustments, and pass the improved mock-ups to developers.

Create mobile content with Adobe Device Central and Photoshop

- 1 Start Photoshop.
- 2 Select File > New.
- 3 Click Device Central to close the dialog box in Photoshop and open Device Central.
- 4 Select a content type.

The Online Library list on the left is updated and shows the devices that support the content type selected.

- 5 Select one or more target devices from the Online Library list, and drag them to the Local Library list. Then, select a target device in the Local Library list.

Device Central lists proposed document sizes based on the device or devices you selected (if the devices have different display sizes). Depending on the design or content you are developing, you can create a separate mobile document for each display size or try to find one size appropriate for all devices. When choosing the second approach, you may want to use the smallest or largest suggested document size as a common denominator. You can even specify a custom size at the bottom of the tab.

- 6 Click Create.

A blank PSD file with the specified size opens in Photoshop. The new file has the following parameters set by default:

- Color Mode: RGB/8bit
- Resolution: 72 ppi
- Color Profile: SRGB IEC61966-2.1

- 7 Fill the blank PSD file with content in Photoshop.
- 8 When you finish, select File > Save For Web & Devices.
- 9 In the Save For Web & Devices dialog box, select the desired format and change other export settings as desired.
- 10 Click Device Central.

A temporary file with the export settings specified is displayed in the Device Central Emulator tab. To continue testing, double-click the name of a different device in the Device Sets or Local Library list.

- 11 If, after previewing the file in Device Central, make changes to the file, go back to Photoshop.

- 12 In the Photoshop Save For Web & Devices dialog box, make adjustments, such as selecting a different format or quality for export.

13 To test the file again with the new export settings, click the Device Central button.

14 When you are satisfied with the results, click Save in the Photoshop Save For Web & Devices dialog box.

Note: To open Device Central from Photoshop (instead of creating and testing a file), select File > Device Central.

For a tutorial about creating content using Photoshop and Device Central, see <http://www.adobe.com/go/vid0185>.

Saving PDF files

Saving files in Photoshop PDF format

You can use the Save As command to save RGB, indexed-color, CMYK, grayscale, Bitmap-mode, Lab color, and duotone images in Photoshop PDF format. Because the Photoshop PDF document can preserve Photoshop data, such as layers, alpha channels, notes, and spot color, you can open the document and edit the images in Photoshop CS2 or later. You can also use the Photoshop PDF format to save multiple images in a multipage document or slide show presentation.

 You can quickly save a file as Photoshop PDF by playing the Save As Photoshop PDF action on the file. You can access this action by choosing Production from the Actions panel menu.

For advanced users, the Photoshop PDF format offers options for making the document PDF/X compliant, which is essential, for example, when you send your document to a large commercial press. PDF/X (Portable Document Format Exchange) is a subset of Adobe PDF that eliminates color, font, and trapping variables that lead to printing problems.

You can also specify security options for restricting access to the PDF document. The 128-bit RC4 (Acrobat 6 and later) encryption has an option for letting users view metadata and thumbnails in a secure PDF document using Adobe Bridge.

You can save your PDF settings as a PDF preset for creating consistent Photoshop PDF files. Adobe PDF presets and settings are shared across Adobe Creative Suite components, including Photoshop, InDesign®, Illustrator®, GoLive®, and Acrobat®.

 Adobe Creative Suite users can find more information about shared PDF settings for Adobe Creative Suite applications in the PDF Integration Guide on the Creative Suite CD.

See also

[“Save an Adobe PDF preset”](#) on page 450

[“Play an action on a file”](#) on page 615

Save a file in Photoshop PDF format

- 1 Choose File > Save As, and then choose Photoshop PDF from the Format menu. You can select a Color option if you want to embed a color profile or use the profile specified with the Proof Setup command. You can also include layers, notes, spot color, or alpha channels. Click Save.
- 2 In the Save Adobe PDF dialog box, choose an Adobe PDF preset specifying whether the Photoshop PDF file will be printed on a desktop printer or proofer, sent to a commercial printer, distributed by e-mail, displayed on the web, and so on. For details, see [“Adobe PDF presets”](#) on page 445.

Choosing a preset is the easiest way to set options for your Photoshop PDF file. After you choose a preset, click Save PDF to generate your Photoshop PDF file. If you want to add security options or fine-tune the saving options for the PDF, follow the remaining steps in this procedure.

- 3 (Optional) Choose options from the Standard menu and the Compatibility menu to specify the PDF/X compliance and the Acrobat version compatibility for the PDF document. For more information, see “[PDF compatibility levels](#)” on page 447.
- 4 (Optional) Select General in the left pane of the Save Adobe PDF dialog box to set general PDF file saving options. For details of each option, see “[General options for Adobe PDF](#)” on page 448.

Note: Users of Photoshop versions earlier than Photoshop CS can open a PDF (containing Photoshop data) as a generic PDF with the layers flattened. Choose File > Open As and then choose Generic PDF from the Files Of Type menu (Windows), or choose File > Open and choose Generic PDF from the Format menu (Mac OS).

- 5 (Optional) Select Compression in the left pane of the Save Adobe PDF dialog box to specify the compression and downsampling options for the PDF file. For more information, see “[Compression and downsampling options for Adobe PDF](#)” on page 448.
- 6 (Optional) Select Output in the left pane of the Save Adobe PDF dialog box to specify color management and PDF/X options. For more information, see “[Color management and PDF/X options for Adobe PDF](#)” on page 450.
- 7 (Optional) To add security to your PDF document, select Security in the left pane of the Save Adobe PDF dialog box. Specify the password and permissions options for your PDF document. See also “[Adding security to PDF files](#)” on page 450.

Note: The Encryption Level depends on the Compatibility setting of your PDF document. Choose a different Compatibility setting to specify a higher or lower Encryption Level.

- 8 (Optional) Select Summary in the left pane of the Save Adobe PDF dialog box. You can review the options you specified.
- 9 (Optional) If you want to reuse the PDF save settings, click Save Preset and save your settings as a PDF preset. The new preset appears in the Adobe PDF Preset menu the next time you save a Photoshop PDF file and in any product in the Adobe Creative Suite. See also “[Save an Adobe PDF preset](#)” on page 450.
- 10 Click Save PDF. Photoshop closes the Save Adobe PDF dialog box and creates the PDF document file.

See also

“[About file formats and compression](#)” on page 457

Adobe PDF presets

A PDF *preset* is a group of settings that affect the process of creating a PDF. These settings are designed to balance file size with quality, depending on how the PDF will be used. Most predefined presets are shared across Adobe Creative Suite components, including InDesign, Illustrator, Photoshop, and Acrobat. You can also create and share custom presets for your unique output requirements.

A few of the presets listed below are not available until you move them—as needed—from the Extras folder (where they are installed by default) to the Settings folder. Typically, the Extras and Settings folders are found in (Windows Vista) ProgramData\Adobe\AdobePDF, (Windows XP) Documents and Settings\All Users\Application Data\Adobe\Adobe PDF, or (Mac OS) Library/Application Support/Adobe PDF. Some presets are not available in some Creative Suite components.

The custom settings are found in (Windows XP) Documents and Settings/[username]/Application Data/Adobe/Adobe PDF/Settings, (Windows Vista) Users/[username]/AppData/Roaming/Adobe/Adobe PDF/Settings, or (Mac OS) Users/[username]/Library/Application Support/Adobe/Adobe PDF/Settings.

 Review your PDF settings periodically. The settings do not automatically revert to the default settings. Applications and utilities that create PDFs use the last set of PDF settings defined or selected.

High Quality Print Creates PDFs for quality printing on desktop printers and proofing devices. This preset uses PDF 1.4 (Windows) or PDF 1.6 (Mac OS), downsamples color and grayscale images to 300 ppi and monochrome images to 1200 ppi, embeds subsets of all fonts, leaves color unchanged, and does not flatten transparency (for file types capable of transparency). These PDFs can be opened in Acrobat 5.0 and Acrobat Reader 5.0 and later. In InDesign, this preset also creates tagged PDFs.

Illustrator Default (Illustrator only) Creates a PDF in which all Illustrator data is preserved. PDFs created with this preset can be reopened in Illustrator without any loss of data.

Oversized Pages (Acrobat only) Creates PDFs suitable for viewing and printing of engineering drawings larger than 200 x 200 inches. These PDFs can be opened in Acrobat and Reader 7.0 and later.

PDF/A-1b: 2005 (CMYK and RGB) (Acrobat only) Used for long-term preservation (archival) of electronic documents. PDF/A-1b uses PDF 1.4 and converts all colors to either CMYK or RGB, depending on which standard you choose. These PDFs can be opened in Acrobat and Reader versions 5.0 and later.

PDF/X-1a (2001 and 2003) PDF/X-1a requires all fonts to be embedded, the appropriate marks and bleeds to be specified, and color to appear as CMYK, spot colors, or both. Compliant files must contain information describing the printing condition for which they are prepared. PDF files created with PDF/X-1a compliance can be opened in Acrobat 4.0 and Acrobat Reader 4.0 and later.

PDF/X-1a uses PDF 1.3, downsamples color and grayscale images to 300 ppi and monochrome images to 1200 ppi, embeds subsets of all fonts, creates untagged PDFs, and flattens transparency using the High Resolution setting.

Note: The PDF/X1-a:2003 and PDF/X-3 (2003) presets are placed on your computer during installation but are not available until you move them from the Extras folder to the Settings folder.

PDF/X-4 (2008) In Acrobat 8, this preset is called PDF/X-4 DRAFT to reflect the draft state of the ISO specification at Acrobat ship time. This preset is based on PDF 1.4, which includes support for live transparency. PDF/X-4 has the same color management and *International Color Consortium* (ICC) color specifications as PDF/X-3. You can create PDF/X-4-compliant files directly with Creative Suite 3 components (Illustrator, InDesign, and Photoshop). In Acrobat 8, use the Preflight feature to convert PDFs to PDF/X-4 DRAFT.

PDF files created with PDF/X-4 compliance can be opened in Acrobat 7.0 and Reader 7.0 and later.

Press Quality Creates PDF files for high-quality print production (for example, for digital printing or for separations to an imagesetter or platesetter), but does not create files that are PDF/X-compliant. In this case, the quality of the content is the highest consideration. The objective is to maintain all the information in a PDF file that a commercial printer or print service provider needs in order to print the document correctly. This set of options uses PDF 1.4, converts colors to CMYK, downsamples color and grayscale images to 300 ppi and monochrome images to 1200 ppi, embeds subsets of all fonts, and preserves transparency (for file types capable of transparency).

These PDF files can be opened in Acrobat 5.0 and Acrobat Reader 5.0 and later.

Note: Before creating an Adobe PDF file to send to a commercial printer or print service provider, find out what the output resolution and other settings should be, or ask for a .joboptions file with the recommended settings. You might need to customize the Adobe PDF settings for a particular provider and then provide a .joboptions file of your own.

Rich Content PDF Creates accessible PDF files that include tags, hyperlinks, bookmarks, interactive elements, and layers. This set of options uses PDF 1.5 and embeds subsets of all fonts. It also optimizes files for byte serving. These PDF files can be opened in Acrobat 6.0 and Adobe Reader 6.0 and later. (The Rich Content PDF preset is in the Extras folder.)

Note: This preset was called eBook in earlier versions of some applications.

Smallest File Size Creates PDF files for displaying on the web, an intranet, or for email distribution. This set of options uses compression, downsampling, and a relatively low image resolution. It converts all colors to sRGB and embeds fonts. It also optimizes files for byte serving.

These PDF files can be opened in Acrobat 5.0 and Acrobat Reader 5.0 and later.

Standard (Acrobat only) Creates PDF files to be printed to desktop printers or digital copiers, published on a CD, or sent to a client as a publishing proof. This set of options uses compression and downsampling to keep the file size down, but also embeds subsets of all (allowed) fonts used in the file, converts all colors to sRGB, and prints to a medium resolution. Note that Windows font subsets are not embedded by default. PDF files created with this settings file can be opened in Acrobat 5.0 and Acrobat Reader 5.0 and later.

 For more information about shared PDF settings for Creative Suite components, see the *PDF Integration Guide on the Creative Suite DVD*.

About PDF/X and PDF/A standards

PDF/X and PDF/A standards are defined by the International Organization for Standardization (ISO). PDF/X standards apply to graphic content exchange; PDF/A standards apply to long-term archiving of electronic documents. During PDF conversion, the file that is being processed is checked against the specified standard. If the PDF will not meet the selected ISO standard, a message appears, asking you to choose between canceling the conversion or going ahead with the creation of a noncompliant file.

The most widely used standards for a print publishing workflow are several PDF/X formats: PDF/X-1a, PDF/X-3, and (in 2007) PDF/X-4. The most widely used standards for PDF archiving are PDF/A-1a, and PDF/A-1b (for less stringent requirements).

Note: For more information on PDF/X and PDF/A, see the [ISO website](#) and the [Adobe website](#).

PDF compatibility levels

When you create PDFs, you need to decide which PDF version to use. You can change the PDF version by switching to a different preset or choosing a compatibility option when you save as PDF or edit a PDF preset.

Generally speaking, unless there's a specific need for backward compatibility, you should use the most recent version (in this case version 1.7). The latest version will include all the newest features and functionality. However, if you're creating documents that will be distributed widely, consider choosing Acrobat 5 (PDF 1.4) or Acrobat 6 (PDF 1.5) to ensure that all users can view and print the document.

The following table compares some of the functionality in PDFs created using the different compatibility settings.

Acrobat 4 (PDF 1.3)	Acrobat 5 (PDF 1.4)	Acrobat 6 (PDF 1.5)	Acrobat 7 (PDF 1.6) and Acrobat 8 and Acrobat 9 (PDF 1.7)
PDFs can be opened with Acrobat 3.0 and Acrobat Reader 3.0 and later.	PDFs can be opened with Acrobat 3.0 and Acrobat Reader 3.0 and later. However, features specific to later versions may be lost or not viewable.	Most PDFs can be opened with Acrobat 4.0 and Acrobat Reader 4.0 and later. However, features specific to later versions may be lost or not viewable.	Most PDFs can be opened with Acrobat 4.0 and Acrobat Reader 4.0 and later. However, features specific to later versions may be lost or not viewable.
Cannot contain artwork that uses live transparency effects. Any transparency must be flattened prior to converting to PDF 1.3.	Supports the use of live transparency in artwork. (The Acrobat Distiller feature flattens transparency.)	Supports the use of live transparency in artwork. (The Acrobat Distiller feature flattens transparency.)	Supports the use of live transparency in artwork. (The Acrobat Distiller feature flattens transparency.)
Layers are not supported.	Layers are not supported.	Preserves layers when creating PDFs from applications that support the generation of layered PDF documents, such as Illustrator CS and later or InDesign CS and later.	Preserves layers when creating PDFs from applications that support the generation of layered PDF documents, such as Illustrator CS and later or InDesign CS and later.
DeviceN color space with 8 colorants is supported.	DeviceN color space with 8 colorants is supported.	DeviceN color space with up to 31 colorants is supported.	DeviceN color space with up to 31 colorants is supported.
Multibyte fonts can be embedded. (Distiller converts the fonts when embedding.)	Multibyte fonts can be embedded.	Multibyte fonts can be embedded.	Multibyte fonts can be embedded.
40-bit RC4 security supported.	128-bit RC4 security supported.	128-bit RC4 security supported.	128-bit RC4 and 128-bit AES (Advanced Encryption Standard) security supported.

General options for Adobe PDF

You can set the following options in the General section of the Adobe PDF Options dialog box:

Description Displays the description from the selected preset, and provides a place for you to edit the description. You can paste a description from the clipboard. If you edit the description of a preset, the word “(Modified)” is added at the end of the preset name.

Preserve Photoshop Editing Capabilities Preserves Photoshop data in the PDF, such as layers, alpha channels, and spot colors. Photoshop PDF documents with this option can be opened only in Photoshop CS2 and later.

Embed Page Thumbnails Creates a thumbnail image of artwork.

Optimize For Fast Web View Optimizes the PDF file for faster viewing in a web browser.

View PDF After Saving Opens the newly created PDF file in the default PDF viewing application.

Compression and downsampling options for Adobe PDF

When saving artwork in Adobe PDF, you can compress text and line art, and compress and downsample bitmap images. Depending on the settings you choose, compression and downsampling can significantly reduce the size of a PDF file with little or no loss of detail and precision.

The Compression area of the Adobe PDF Options dialog box is divided into three sections. Each section provides the following options for compressing and resampling images in your artwork.

Downsampling If you plan to use the PDF file on the web, use downsampling to allow for higher compression. If you plan to print the PDF file at high resolution, do not use downsampling. Select the Do Not Downsample option to disable all downsampling options.

Downsampling refers to decreasing the number of pixels in an image. To downsample images, choose an *interpolation method*—average downsampling, subsampling, or bicubic downsampling—and enter the desired resolution (in pixels per inch). Then enter a resolution in the For Images Above box. All images with resolution above this threshold are downsampled.

The interpolation method you choose determines how pixels are deleted:

- **Average Downsampling To** Averages the pixels in a sample area and replaces the entire area with the average pixel color at the specified resolution. Average downsampling is the same as Bilinear resampling.
- **Subsampling To** Chooses a pixel in the center of the sample area and replaces the entire area with that pixel color. Subsampling significantly reduces the conversion time compared with downsampling but results in images that are less smooth and continuous. Subsampling is the same as Nearest Neighbor resampling.
- **Bicubic Downsampling To** Uses a weighted average to determine pixel color, which usually yields better results than the simple averaging method of downsampling. Bicubic is the slowest but most precise method, resulting in the smoothest gradations.

Compression Determines the type of compression that is used.

- **ZIP compression** Works well on images with large areas of single colors or repeating patterns, and for black-and-white images that contain repeating patterns. ZIP compression is lossless.
- **JPEG compression** Is suitable for grayscale or color images. JPEG compression is *lossy*, which means that it removes image data and may reduce image quality; however, it attempts to reduce file size with a minimal loss of information. Because JPEG compression eliminates data, it can achieve much smaller file sizes than ZIP compression.
- **JPEG2000** Is the new international standard for the compression and packaging of image data. Like JPEG compression, JPEG2000 compression is suitable for grayscale or color images. It also provides additional advantages, such as progressive display and lossless compression not available with JPEG. JPEG2000 is only available if Acrobat 6 (PDF 1.5) or later is selected from the Compatibility menu.

Image Quality Determines the amount of compression that is applied. The available options depend on the compression method. For JPEG2000 compression, Photoshop provides Lossless, Maximum, High, Medium, Low, and Minimum options. For JPEG compression, Photoshop provides Minimum, Low, Medium, High, and Maximum options. For ZIP compression, Photoshop provides an 8-bit Image Quality option. The 8-bit Image Quality option is lossless; that is, data is not removed to reduce file size, so image quality is not affected.

Tile Size Specifies the size of the tiles used in images with JPEG 2000 compression. When low Image Quality values are used to optimize images smaller than 1024 x 1024 pixels, using the largest tile size produces better results. In general, a tile size of 1024 is best for most images. Lower tile sizes are generally used for images with small dimensions (for viewing on devices such as mobile phones).

Convert 16 Bit/Channel Image To 8 Bit/Channel Converts 16-bits-per-channel images to 8-bits-per-channel images (selected by default). ZIP is the only compression method available if the Convert 16 Bits option is unselected. If your document's Compatibility setting is Acrobat 5 (PDF 1.4) or earlier, the Convert 16 Bits option is unavailable, and images are automatically converted to 8 bits per channel.

Color management and PDF/X options for Adobe PDF

You can set the following options in the Output section of the Adobe PDF Options dialog box. Interactions between Output options change depending on whether Color Management is on or off and which PDF standard is selected.

Color Conversion Specifies how to represent color information in the Adobe PDF file. When you convert color objects to RGB or CMYK, also select a destination profile from the pop-up menu. All spot color information is preserved during color conversion; only the process color equivalents convert to the designated color space.

- **No Conversion** Preserves color data as is.
- **Convert To Destination** Converts all colors to the profile selected for Destination. Whether the profile is included or not is determined by the Profile Inclusion Policy.

Destination Describes the gamut of the final RGB or CMYK output device, such as your monitor or a SWOP standard. Using this profile, Photoshop converts the document's color information (defined by the source profile in the Working Spaces section of the Color Settings dialog box) to the color space of the target output device.

Profile Inclusion Policy Determines whether a color profile is included in the file.

Output Intent Profile Name Specifies the characterized printing condition for the document. An output intent profile is required for creating PDF/X-compliant files. This menu is available only if a PDF/X standard (or preset) is selected in the Adobe PDF Options dialog box.

Output Condition Describes the intended printing condition. This entry can be useful for the intended receiver of the PDF document.

Output Condition Identifier A pointer to more information on the intended printing condition. The identifier is automatically entered for printing conditions that are included in the ICC registry.

Registry Name Indicates the web address for more information on the registry. The URL is automatically entered for ICC registry names.

Adding security to PDF files

When saving as PDF, you can add password protection and security restrictions, limiting not only who can open the file, but also who can copy or extract contents, print the document, and more.

A PDF file can require passwords to open a document (document open password) and to change security settings (permissions password). If you set any security restrictions in your file, you should set both passwords; otherwise, anyone who opens the file could remove the restrictions. If a file is opened with a permissions password, the security restrictions are temporarily disabled.

The RC4 method of security from RSA Corporation is used to password-protect PDF files. Depending on the Compatibility setting (in the General category), the encryption level will be high or low.

***Note:** Adobe PDF presets don't support passwords and security settings. If you select passwords and security settings in the Export Adobe PDF dialog box, and then click Save Preset, the passwords and security settings won't be preserved.*

Save an Adobe PDF preset

Although the default PDF presets are based on best practices, you may discover that your workflow requires specialized PDF settings that aren't available using any of the built-in presets. In this case, you can create and save your own custom presets for reuse in Photoshop or any product in the Adobe Creative Suite.

In Photoshop, you can save the preset using the Adobe PDF Presets command or clicking the Save Preset button in the Save Adobe PDF dialog box. Adobe PDF presets are saved as files with a .joboptions extension. This is useful, for example, if you want your vendor or printer to send you a .joboptions file with the Adobe PDF presets that work best with their workflow.

1 Do one of the following:

- Choose Edit > Adobe PDF Presets.
- If you're saving a Photoshop PDF document, click the Save Preset button in the Save Adobe PDF dialog box after you specify your PDF settings. Skip steps 2 and 3.

2 If you chose the Adobe PDF Presets command, do one of the following in the Adobe PDF Presets dialog box:

- To create a new preset, click the New button in the Adobe PDF Presets dialog box. In the New PDF Preset dialog box, type a name for the preset in the Preset text box.
- To edit an existing custom preset, select the preset and click Edit. (You can't edit the default presets.)

3 Set the PDF options.

4 Save your preset by doing one of the following:

- In the New PDF Preset or the Edit PDF Preset dialog box, click OK. The new preset appears in the Adobe PDF Presets list. Click Done when you finish creating presets.
- In the Save dialog box, type a name for the preset in the File Name text box and click Save.

Adobe PDF presets are stored in the following folders:

- (Windows Vista) Users/[user name]/AppData/Roaming/Adobe/Adobe PDF/Settings
- (Windows XP) Documents and Settings/[user name]/Application Data/Adobe/Adobe PDF/Settings
- (Mac OS) Users/[user name]/Library/Application Support/Adobe/Adobe PDF/Settings

All the Adobe PDF presets you save in these locations are available in your other Adobe Creative Suite applications.

Note: To save the PDF preset in a location other than the default, click the Save As button in the Adobe PDF Presets dialog box and browse to the destination, or in the Save dialog box, browse to the destination and click Save.

See also

[“Save a file in Photoshop PDF format”](#) on page 444

Load, edit, or delete Adobe PDF presets

Adobe PDF *presets* (creation settings) are available in Photoshop and other products in the Adobe Creative Suite. From the Adobe PDF Presets dialog box, you save, load, edit, or delete Adobe PDF presets.

❖ Choose Edit > Adobe PDF Presets and do any of the following:

- To save settings as a new preset, click the New button, specify settings in the New PDF Preset dialog box, and click OK.
- To edit an Adobe PDF preset, select the preset in the Preset window, click the Edit button, and change settings in the Edit PDF Preset dialog box.

Note: Although you can't edit the Adobe PDF presets that were installed with Photoshop (the names of presets installed with Photoshop are enclosed in square brackets), you can select one of them and click the New button. In the New PDF Preset dialog box, you can modify the settings and save them as a new preset.

- To delete an Adobe PDF preset, select the preset in the Preset window and click the Delete button. You can't delete the Adobe PDF presets that were installed with Photoshop.
- To load an Adobe PDF preset, click the Load button, select the preset file, and click the Load button. The preset is added to the Presets window.

 *When you browse for an Adobe PDF preset to load, only files with the .joboptions extension are visible in the Load dialog box.*

- To close the PDF Options Preset dialog box, click the Done button.
- To save a preset in a location other than the default, click the Save As button, give the preset a new name (if necessary), browse to the destination, and click Save.

See also

[“Save an Adobe PDF preset”](#) on page 450

Saving and exporting files in other formats

Save a file in TIFF format

TIFF is a flexible raster (bitmap) image format supported by virtually all paint, image-editing, and page-layout applications.

- 1 Choose File > Save As, choose TIFF from the Format menu, and click Save.
- 2 In the TIFF Options dialog box, select the options you want, and click OK.

Bit depth (32-bit only) Specifies the bit depth (16-, 24-, or 32-bit) of the saved image.

Image Compression Specifies a method for compressing the composite image data. If you're saving a 32-bit TIFF file, you can specify that the file be saved with predictor compression, but you don't have the option to use JPEG compression. Predictor compression offers improved compression by rearranging floating point values, and works with both LZW and ZIP compression.

Pixel Order Writes the TIFF file with the channels data interleaved or organized by plane. Previously, Photoshop always wrote TIFF files with the channel order interleaved. Theoretically, the Planar order file can be read and written faster, and offers a little better compression. Both channel orders are backward compatible with earlier versions of Photoshop.

Byte Order Selects the platform on which the file can be read. This option is useful when you don't know what program the file may be opened in. Photoshop and most recent applications can read files using either IBM PC or Macintosh byte order.

Save Image Pyramid Preserves multiresolution information. Photoshop does not provide options for opening multiresolution files; the image opens at the highest resolution within the file. However, Adobe InDesign and some image servers provide support for opening multiresolution formats.

Save Transparency Preserves transparency as an additional alpha channel when the file is opened in another application. Transparency is always preserved when the file is reopened in Photoshop.

Layer Compression Specifies a method for compressing data for pixels in layers (as opposed to composite data). Many applications cannot read layer data and skip over it when opening a TIFF file. Photoshop, however, can read layer data in TIFF files. Although files that include layer data are larger than those that don't, saving layer data eliminates the

need to save and manage a separate PSD file to hold the layer data. Choose Discard Layers And Save A Copy if you want to flatten the image.

Note: To have Photoshop prompt you before saving an image with multiple layers, select Ask Before Saving Layered TIFF Files in the File Handling area of the Preferences dialog box.

See also

[“TIFF”](#) on page 463

[“About file formats and compression”](#) on page 457

Save a file in JPEG format

You can use the Save As command to save CMYK, RGB, and grayscale images in JPEG format. JPEG compresses file size by selectively discarding data. You can also save an image as one or more JPEG using the Save For Web & Devices command.

Note: JPEG is only available when the image is 8 Bits/Channel (it only supports 8 Bit/Channel).

 To quickly save a medium-quality JPEG, play the Save As JPEG Medium action on the file. You can access this action by choosing Production from the Actions panel menu.

- 1 Choose File > Save As, and choose JPEG from the Format menu.
- 2 In the JPEG Options dialog box, select the options you want, and click OK.

Matte Offers matte color choices to simulate the appearance of background transparency in images that contain transparency.

Image Options Specifies the image quality. Choose an option from the Quality menu, drag the Quality pop-up slider, or enter a value between 0 and 12 in the Quality text box.

Format Options Specifies the format of your JPEG file. Baseline (“Standard”) uses a format recognized by most web browsers. Baseline Optimized creates a file with optimized color and a slightly smaller file size. Progressive displays a series of increasingly detailed versions of the image (you specify how many) as it downloads.

Note: Not all web browsers support optimized and Progressive JPEG images.

Note: Some applications may not be able to read a CMYK file saved in JPEG format. In addition, if you find that a Java application can’t read your JPEG file (in any color mode), try saving the file without a thumbnail preview.

See also

[“About file formats and compression”](#) on page 457

[“JPEG format”](#) on page 461

[“Play an action on a file”](#) on page 615

Save a file in PNG format

You can use the Save As command to save RGB, Indexed Color, Grayscale, and Bitmap mode images in PNG format.

Note: You can also save an image as one or more PNG files using the Save For Web & Devices command.

- 1 Choose File > Save As, and choose PNG from the Format menu.
- 2 Select an Interlace option:

None Displays the image in a browser only when download is complete.

Interlaced Displays low-resolution versions of the image in a browser as the file downloads. Interlacing makes download time seem shorter, but it also increases file size.

3 Click OK.

See also

“[PNG format](#)” on page 462

Save a file in GIF format

You can use the Save As command to save RGB, Indexed Color, Grayscale, or Bitmap mode images directly in CompuServe GIF (known as GIF) format. The image is automatically converted to Indexed Color mode.

Note: GIF is only available when the image is 8 Bits/Channel (it only supports 8 Bit/Channel).

- 1 Choose File > Save As, and choose CompuServe GIF from the Format menu.
- 2 For RGB images, the Indexed Color dialog box appears. Specify conversion options and click OK.
- 3 Select a row order for the GIF file, and click OK:

Normal Displays the image in a browser only when download is complete.

Interlaced Displays low-resolution versions of the image in a browser as the file downloads. Interlacing makes download time seem shorter, but it also increases file size.

Note: You can also save an image as one or more GIF files using the Save For Web & Devices command.

See also

“[GIF](#)” on page 460

“[Convert a grayscale or RGB image to indexed color](#)” on page 111

Save a file in Photoshop EPS format

Virtually all page-layout, word-processing, and graphics applications accept imported or placed EPS (Encapsulated PostScript) files. To print EPS files, you should use a PostScript printer. Non-PostScript printers will print only the screen-resolution preview.

- 1 Choose File > Save As, and choose Photoshop EPS from the Format menu.
- 2 In the EPS Options dialog box, select the options you want, and click OK:

Preview Creates a low-resolution image to view in the destination application. Choose TIFF to share an EPS file between Windows and Mac OS systems. An 8-bit preview is in color and a 1-bit preview is in black and white with a jagged appearance. An 8-bit preview creates a larger file size than a 1-bit preview. See also “[Bit depth](#)” on page 55.

Encoding Determines the way image data is delivered to a PostScript output device. Encoding options are described below.

Include Halftone Screen and Include Transfer Function Control print specifications for high-end commercial print jobs. Consult your printer before selecting these options.

Transparent Whites Displays white areas as transparent. This option is available only for images in Bitmap mode.

PostScript Color Management Converts file data to the printer’s color space. Do not select this option if you plan to place the image in another color-managed document.

Note: Only PostScript Level 3 printers support PostScript Color Management for CMYK images. To print a CMYK image using PostScript Color Management on a Level 2 printer, convert the image to Lab mode before saving in EPS format.

Include Vector Data Preserves any vector graphics (such as shapes and type) in the file. However, vector data in EPS and DCS files is available only to other applications; vector data is rasterized if you reopen the file in Photoshop. This option is only available if your file contains vector data.

Image Interpolation Applies anti-aliasing to the printed low-resolution image.

See also

[“Photoshop EPS format”](#) on page 458

Photoshop EPS encoding options

ASCII or ASCII85 Encodes if you’re printing from a Windows system, or if you’re experience printing errors or other difficulties.

Binary Produces a smaller file and leaves the original data intact. However, some page-layout applications and some commercial print spooling and network printing software may not support binary Photoshop EPS files.

JPEG Compresses the file by discarding some image data. You can choose the amount of JPEG compression from very little (JPEG Maximum Quality) to a lot (JPEG Low Quality). Files with JPEG encoding can be printed only on Level 2 (or later) PostScript printers and may not separate into individual plates.

Save a file in Photoshop DCS format

DCS (Desktop Color Separations) format is a version of EPS that lets you save color separations of CMYK or multichannel files.

- 1 Choose File > Save As, and choose Photoshop DCS 1.0 or Photoshop DCS 2.0 from the Format menu.
- 2 In the DCS Format dialog box, select the options you want, and click OK.

The dialog box includes all the options available for Photoshop EPS files. Additionally, the DCS menu gives you the option of creating a 72-ppi composite file that can be placed in a page-layout application or used to proof the image:

DCS 1.0 format Creates one file for each color channel in a CMYK image. You can also create a fifth file: a grayscale or color composite. To view the composite file, you must keep all five files in the same folder.

DCS 2.0 format Retains spot color channels in the image. You can save the color channels as multiple files (as for DCS 1.0) or as a single file. The single-file option saves disk space. You can also include a grayscale or color composite.

See also

[“Photoshop DCS 1.0 and 2.0 formats”](#) on page 458

Save a file in Photoshop Raw format

The Photoshop Raw format is a file format for transferring images between applications and computer platforms. The Photoshop Raw format is not the same as camera raw.

- 1 Choose File > Save As, and choose Photoshop Raw from the Format menu.
- 2 In the Photoshop Raw Options dialog box, do the following:
 - (Mac OS) Specify values for File Type and File Creator, or accept the default values.
 - Specify a Header parameter.

- Select whether to save the channels in an interleaved or non-interleaved order.

See also

[“Photoshop Raw format”](#) on page 459

Save a file in BMP format

The BMP format is an image format for the Windows operating system. The images can range from black-and-white (1 byte per pixel) up to 24-bit color (16.7 million colors).

- 1 Choose File > Save As, and choose BMP from the Format menu.
- 2 Specify a filename and location, and click Save.
- 3 In the BMP Options dialog box, select a file format, specify the bit depth and, if necessary, select Flip Row Order. For more options, click Advanced Modes and specify the BMP options.
- 4 Click OK.

See also

[“BMP format”](#) on page 460

Save a 16-bits-per-channel file in Cineon format

RGB images that are 16 bits per channel can be saved in Cineon format for use in the Kodak Cineon Film System.

- ❖ Choose File > Save As and choose Cineon from the Format menu.

See also

[“Cineon format”](#) on page 460

Save a file in Targa format

The Targa (TGA) format supports bitmap and RGB images with 8 Bits/Channel. It is designed for Truevision® hardware, but it is also used in other applications.

- 1 Choose File > Save As, and choose Targa from the Format menu.
- 2 Specify a filename and location, and click Save.
- 3 In the Targa Options dialog box, select a resolution, select the Compress (RLE) option if you want to compress the file, and then click OK.

See also

[“Targa”](#) on page 463

Export layers to files

You can export and save layers as individual files using a variety of formats, including PSD, BMP, JPEG, PDF, Targa, and TIFF. Layers are named automatically as they are saved. You can set options to control the generation of names.

- 1 Choose File > Scripts > Export Layers To Files.

- 2 In the Export Layers To Files dialog box, under Destination, click Browse to select a destination for the exported files. By default, the generated files are saved in the sample folder as the source file.
- 3 Enter a name in the File Name Prefix text box to specify a common name for the files.
- 4 Select the Visible Layers Only option if you want to export only those layers that have visibility enabled in the Layers panel. Use this option if you don't want all the layers exported. Turn off visibility for layers that you don't want exported.
- 5 Choose a file format from the File Type menu. Set options as necessary.
- 6 Select the Include ICC Profile option if you want the working space profile embedded in the exported file. This is important for color-managed workflows.
- 7 Click Run.

File formats

About file formats and compression

Graphics file formats differ in the way they represent image data (as pixels or vectors), in compression techniques, and which Photoshop features they support. With a few exceptions (for instance Large Document Format (PSB), Photoshop Raw, and TIFF), most file formats cannot support documents larger than 2 GB.

Note: If a supported file format does not appear in the appropriate dialog box or submenu, you may need to install the format's plug-in module.

About file compression

Many file formats use compression to reduce the file size of bitmap images. *Lossless* techniques compress the file without removing image detail or color information; *lossy* techniques remove detail. The following are commonly used compression techniques:

RLE (Run Length Encoding) Lossless compression; supported by some common Windows file formats.

LZW (Lemple-Zif-Welch) Lossless compression; supported by TIFF, PDF, GIF, and PostScript language file formats. Most useful for images with large areas of single color.

JPEG (Joint Photographic Experts Group) Lossy compression; supported by JPEG, TIFF, PDF, and PostScript language file formats. Recommended for continuous-tone images, such as photographs. JPEG uses lossy compression. To specify image quality, choose an option from the Quality menu, drag the Quality pop-up slider, or enter a value between 0 and 12 in the Quality text box. For the best printed results, choose maximum-quality compression. JPEG files can be printed only on Level 2 (or later) PostScript printers and may not separate into individual plates.

CCITT A family of lossless compression techniques for black-and-white images, supported by the PDF and PostScript language file formats. (CCITT is an abbreviation for the French spelling of International Telegraph and Telekeyed Consultive Committee.)

ZIP Lossless compression; supported by PDF and TIFF file formats. Like LZW, ZIP compression is most effective for images that contain large areas of single color.

See also

[“Saving image files”](#) on page 440

[“About plug-in modules”](#) on page 44

Maximize compatibility when saving files

- 1 Choose Edit > Preferences > File Handling (Windows) or Photoshop > Preferences > File Handling (Mac OS).
- 2 Choose Always from the Maximize PSD and PSB File Compatibility menu. This saves a composite (flattened) image along with the layers of your document.

Note: If file size is an issue or if you're opening your files only in Photoshop, turning off Maximize PSD and PSB File Compatibility reduces the file sizes significantly. From the Maximize PSD and PSB File Compatibility menu, choose either Ask to be asked whether to maximize compatibility when you save or Never to save your document without maximizing compatibility.

If you edit or save an image using an earlier version of Photoshop, unsupported features are discarded.

Photoshop format (PSD)

Photoshop format (PSD) is the default file format and the only format, besides the Large Document Format (PSB), that supports all Photoshop features. Because of the tight integration between Adobe products, other Adobe applications, such as Adobe Illustrator, Adobe InDesign, Adobe Premiere, Adobe After Effects, and Adobe GoLive, can directly import PSD files and preserve many Photoshop features. For more information, see Help for the specific Adobe applications.

When saving a PSD, you can set a preference to maximize file compatibility. This saves a composite version of a layered image in the file so it can be read by other applications, including previous versions of Photoshop. It also maintains the appearance of the document, just in case future versions of Photoshop change the behavior of some features. Including the composite also makes the image much faster to load and use in applications other than Photoshop, and may sometimes be required to make the image readable in other applications.

16-bits-per-channel and high dynamic range 32-bits-per-channel images can be saved as PSD files.

Photoshop 2.0 format

(Mac OS) You can use this format to open an image in Photoshop 2.0 or to export an image to an application supporting only Photoshop 2.0 files. Saving in Photoshop 2.0 format flattens your image and discards layer information.

Photoshop DCS 1.0 and 2.0 formats

Desktop Color Separations (DCS) format is a version of the standard EPS format that lets you save color separations of CMYK images. You can use DCS 2.0 format to export images containing spot channels. To print DCS files, you must use a PostScript printer.

Photoshop EPS format

Encapsulated PostScript (EPS) language file format can contain both vector and bitmap graphics and is supported by virtually all graphics, illustration, and page-layout programs. EPS format is used to transfer PostScript artwork between applications. When you open an EPS file containing vector graphics, Photoshop rasterizes the image, converting the vector graphics to pixels.

EPS format supports Lab, CMYK, RGB, Indexed Color, Duotone, Grayscale, and Bitmap color modes, and does not support alpha channels. EPS does support clipping paths. Desktop Color Separations (DCS) format, a version of the standard EPS format, lets you save color separations of CMYK images. You use DCS 2.0 format to export images containing spot channels. To print EPS files, you must use a PostScript printer.

Photoshop uses the EPS TIFF and EPS PICT formats to let you open images saved in file formats that create previews but are not supported by Photoshop (such as QuarkXPress®). You can edit and use an opened preview image just as any other low-resolution file. An EPS PICT preview is available only in Mac OS.

Note: EPS TIFF format and EPS PICT format are more relevant to earlier versions of Photoshop. The current version of Photoshop includes rasterization features for opening files that include vector data.

Photoshop Raw format

The Photoshop Raw format is a flexible file format for transferring images between applications and computer platforms. This format supports CMYK, RGB, and grayscale images with alpha channels, and multichannel and Lab images without alpha channels. Documents saved in the Photoshop Raw format can be of any pixel or file size, but they cannot contain layers.

The Photoshop Raw format consists of a stream of bytes describing the color information in the image. Each pixel is described in binary format, with 0 representing black and 255 white (for images with 16-bit channels, the white value is 65535). Photoshop designates the number of channels needed to describe the image, plus any additional channels in the image. You can specify the file extension (Windows), file type (Mac OS), file creator (Mac OS), and header information.

In Mac OS, the file type is generally a four-character ID that identifies the file—for example, TEXT identifies the file as an ASCII text file. The file creator is also generally a four-character ID. Most Mac OS applications have a unique file creator ID that is registered with the Apple Computer Developer Services group.

The Header parameter specifies how many bytes of information appear in the file before actual image information begins. This value determines the number of zeroes inserted at the beginning of the file as placeholders. By default, there is no header (header size = 0). You can enter a header when you open the file in Raw format. You can also save the file without a header and then use a file-editing program, such as HEdit (Windows) or Norton Utilities® (Mac OS), to replace the zeroes with header information.

You can save the image in an interleaved or non-interleaved format. If you choose interleaved, the color values (red, green, and blue, for example) are stored sequentially. Your choice depends on requirements of the application that will open the file.

Note: A Photoshop Raw image is not in the same file format as a camera raw image file from a digital camera. A camera raw image file is in a camera-specific proprietary format that is essentially a “digital negative,” with no filtering, white balance adjustments, or other in-camera processing.

See also

[“Save large documents”](#) on page 442

Digital Negative format (DNG)

Digital Negative (DNG) is a file format that contains the raw image data from a digital camera and metadata that defines what the data means. DNG, Adobe’s publicly available, archival format for camera raw files, is designed to provide compatibility and decrease the current proliferation of camera raw file formats. The Camera Raw plug-in can save camera raw image data in the DNG format. For more information about the Digital Negative (DNG) file format, visit www.adobe.com and search on the term “Digital Negative.” You’ll find comprehensive information and a link to a user forum.

See also

[“Save a camera raw image in another format”](#) on page 86

BMP format

BMP is a standard Windows image format on DOS and Windows-compatible computers. BMP format supports RGB, Indexed Color, Grayscale, and Bitmap color modes. You can specify either Windows or OS/2® format and a bit depth of 8 bits/channel. For 4-bit and 8-bit images using Windows format, you can also specify RLE compression.

BMP images are normally written bottom to top; however, you can select the Flip Row Order option to write them from top to bottom. You can also select an alternate encoding method by clicking Advanced Modes. (Flip Row Order and Advanced Modes are most relevant to game programmers and others using DirectX®.)

Cineon format

Developed by Kodak, Cineon is a 10-bits-per-channel digital format suitable for electronic composition, manipulation, and enhancement. Using the Cineon format, you can output back to film with no loss of image quality. The format is used in the Cineon Digital Film System, which transfers images originated on film to the Cineon format and back to film.

DICOM format

The DICOM (Digital Imaging and Communications in Medicine) format is commonly used for the transfer and storage of medical images, such as ultrasounds and scans. DICOM files contain both image data and headers, which store information about the patient and the medical image. You can open, edit, and save DICOM files in Photoshop Extended.

See also

“[DICOM files \(Photoshop Extended\)](#)” on page 597

Filmstrip format

Filmstrip format is used for RGB animation or movie files created by Adobe Premiere Pro®. If you resize, resample, remove alpha channels, or change the color mode or file format of a Filmstrip file in Photoshop, you won't be able to save it back to Filmstrip format. For further guidelines, see Adobe Premiere Pro Help.

GIF

Graphics Interchange Format (GIF) is the file format commonly used to display indexed-color graphics and images in Hypertext Markup Language (HTML) documents over the World Wide Web and other online services. GIF is an LZW-compressed format designed to minimize file size and electronic transfer time. GIF format preserves transparency in indexed-color images; however, it does not support alpha channels.

IFF

IFF (Interchange File Format) is a general-purpose data storage format that can associate and store multiple types of data. IFF is portable and has extensions that support still-picture, sound, music, video, and textual data. The IFF format includes Maya IFF and IFF (formerly Amiga IFF).

JPEG format

Joint Photographic Experts Group (JPEG) format is commonly used to display photographs and other continuous-tone images in hypertext markup language (HTML) documents over the World Wide Web and other online services. JPEG format supports CMYK, RGB, and Grayscale color modes, and does not support transparency. Unlike GIF format, JPEG retains all color information in an RGB image but compresses file size by selectively discarding data.

A JPEG image is automatically decompressed when opened. A higher level of compression results in lower image quality, and a lower level of compression results in better image quality. In most cases, the Maximum quality option produces a result indistinguishable from the original.

Large Document Format

The Large Document Format (PSB) supports documents up to 300,000 pixels in any dimension. All Photoshop features, such as layers, effects, and filters, are supported. You can save high dynamic range, 32-bits-per-channel images as PSB files. Currently, if you save a document in PSB format, it can be opened only in Photoshop CS or later. Other applications and earlier versions of Photoshop cannot open documents saved in PSB format.

Note: Most other applications and older versions of Photoshop cannot support documents with file sizes larger than 2 GB.

See also

“[Save large documents](#)” on page 442

OpenEXR format

OpenEXR (EXR) is a file format used by the visual effects industry for high dynamic range images. The film format has high color fidelity and a dynamic range suitable for use in motion picture production. Developed by Industrial Light and Magic, OpenEXR supports multiple lossless or lossy compression methods. An OpenEXR file supports transparency and only works with 32 bits/channel images; the file format stores the values as 16 bits/channel floating point.

PCX

PCX format is commonly used by IBM PC-compatible computers. Most PC software supports version 5 of PCX format. A standard VGA color palette is used with version 3 files, which do not support custom color palettes.

PCX format supports Bitmap, Grayscale, Indexed Color, and RGB color modes, and does not support alpha channels. PCX supports the RLE compression method. Images can have a bit depth of 1, 4, 8, or 24.

PDF

Portable Document Format (PDF) is a flexible, cross-platform, cross-application file format. Based on the PostScript imaging model, PDF files accurately display and preserve fonts, page layouts, and both vector and bitmap graphics. In addition, PDF files can contain electronic document search and navigation features such as electronic links. PDF supports 16-bits-per-channel images. Adobe Acrobat also has a Touch Up Object tool for minor editing of images in a PDF. For more information about working with images in PDFs, see Acrobat Help.

Note: The Touch Up Object tool is mainly for last-minute revisions to images and objects. It's best to do image editing in Photoshop before saving as PDF.

Photoshop recognizes two types of PDF files: Photoshop PDF files and generic PDF files. You can open both types of PDF files. When you save PDF files, Photoshop saves them as Photoshop PDF files by default. Deselect Preserve Photoshop Editing Capabilities in the General section of the Save PDF dialog box to save a generic PDF file.

Photoshop PDF files Created using the Photoshop Save As command with Preserve Photoshop Editing Capabilities selected in the General section of the Save PDF dialog box. Photoshop PDF files can contain only a single image.

Photoshop PDF format supports all of the color modes (except Multichannel mode) and features that are supported in standard Photoshop format. Photoshop PDF also supports JPEG and ZIP compression, except for Bitmap-mode images, which use CCITT Group 4 compression.

Generic PDF files Created using the Photoshop Save As command, with Preserve Photoshop Editing Capabilities deselected in the General section of the Save PDF dialog box, by creating a PDF presentation in Photoshop, or by using applications other than Photoshop, such as Adobe Acrobat and Adobe Illustrator. They can contain multiple pages and images. When you open a generic PDF file, Photoshop rasterizes the image.

PICT File

PICT format is used in Mac OS graphics and page-layout applications as an intermediary file format for transferring images between applications. PICT format supports RGB images with a single alpha channel and Indexed Color, Grayscale, and Bitmap mode images without alpha channels. PICT format is especially effective for compressing images with large areas of solid color. This compression can be substantial for alpha channels with their large areas of white and black.

When saving an RGB image in PICT format, you can choose either a 16-bit or 32-bit pixel resolution. For bitmap and grayscale images, you can choose from 2, 4, or 8 bits per pixel. In Mac OS with QuickTime™ installed, four JPEG compression options are available.

PICT Resource

(Mac OS) A PICT resource is a PICT file but takes a name and resource ID number. The PICT Resource format supports RGB images with a single alpha channel, and Indexed Color, Grayscale, and Bitmap mode images without alpha channels.

You can use the Import command or the Open command to open a PICT resource. When saving a file as a PICT resource, you can specify the resource ID and resource name. As with other PICT files, you also specify bit depth and compression options.

Pixar format

The Pixar format is designed specifically for high-end graphics applications, such as those used for rendering three-dimensional images and animation. Pixar format supports RGB and grayscale images with a single alpha channel.

PNG format

Developed as a patent-free alternative to GIF, Portable Network Graphics (PNG) format is used for lossless compression and for display of images on the web. Unlike GIF, PNG supports 24-bit images and produces background transparency without jagged edges; however, some web browsers do not support PNG images. PNG format supports RGB, Indexed Color, Grayscale, and Bitmap mode images without alpha channels. PNG preserves transparency in grayscale and RGB images.

Portable Bit Map format

The Portable Bit Map (PBM) file format, also known as Portable Bitmap Library and Portable Binary Map, supports monochrome bitmaps (1 bit per pixel). The format can be used for lossless data transfer because many applications support this format. You can even edit or create such files within a simple text editor.

The Portable Bit Map format serves as the common language of a large family of bitmap conversion filters including Portable FloatMap (PFM), Portable Graymap (PGM), Portable Pixmap (PPM), and Portable Anymap (PNM). While the PBM file format stores monochrome bitmaps, PGM additionally stores grayscale bitmaps, and PPM can also store color bitmaps. PNM is not a different file format in itself, but a PNM file can hold PBM, PGM, or PPN files. PFM is a floating-point image format that can be used for 32-bits-per-channel HDR files.

Radiance format

Radiance (HDR) is a 32-bits-per-channel file format used for high dynamic range images. This format was originally developed for the Radiance system, a professional tool for visualizing lighting in virtual environments. The file format stores the quantity of light per pixel instead of just the colors to be displayed on-screen. The levels of luminosity accommodated by the Radiance format are far higher than the 256 levels in 8-bits-per-channel image file formats. Radiance (HDR) files are often used in 3D modeling.

Scitex CT

Scitex Continuous Tone (CT) format is used for high-end image processing on Scitex computers. Contact Creo to obtain utilities for transferring files saved in Scitex CT format to a Scitex system. Scitex CT format supports CMYK, RGB, and grayscale images and does not support alpha channels.

CMYK images saved in Scitex CT format often have extremely large file sizes. These files are generated for input using a Scitex scanner. Images saved in Scitex CT format are printed to film using a Scitex rasterizing unit, which produces separations using a patented Scitex halftoning system. This system produces very few moiré patterns and is often demanded in professional color work—for example, ads in magazines.

Targa

The Targa (TGA) format is designed for systems using the Truevision video board and is commonly supported by MS-DOS color applications. Targa format supports 16-bit RGB images (5 bits x 3 color channels, plus one unused bit), 24-bit RGB images (8 bits x 3 color channels), and 32-bit RGB images (8 bits x 3 color channels plus a single 8-bit alpha channel). Targa format also supports indexed-color and grayscale images without alpha channels. When saving an RGB image in this format, you can choose a pixel depth and select RLE encoding to compress the image.

TIFF

Tagged-Image File Format (TIFF, TIF) is used to exchange files between applications and computer platforms. TIFF is a flexible bitmap image format supported by virtually all paint, image-editing, and page-layout applications. Also, virtually all desktop scanners can produce TIFF images. TIFF documents have a maximum file size of 4 GB. Photoshop CS and later supports large documents saved in TIFF format. However, most other applications and older versions of Photoshop do not support documents with file sizes greater than 2 GB.

TIFF format supports CMYK, RGB, Lab, Indexed Color, and Grayscale images with alpha channels and Bitmap mode images without alpha channels. Photoshop can save layers in a TIFF file; however, if you open the file in another application, only the flattened image is visible. Photoshop can also save notes, transparency, and multiresolution pyramid data in TIFF format.

In Photoshop, TIFF image files have a bit depth of 8, 16, or 32 bits per channel. You can save high dynamic range images as 32-bits-per-channel TIFF files.

See also

“[Save large documents](#)” on page 442

WBMP format

WBMP format is the standard format for optimizing images for mobile devices, such as cell phones. WBMP supports 1-bit color, which means that WBMP images contain only black and white pixels.

Metadata and notes

About metadata

Metadata is a set of standardized information about a file, such as author name, resolution, color space, copyright, and keywords applied to it. For example, most digital cameras attach some basic information to an image file, such as height, width, file format, and time the image was taken. You can use metadata to streamline your workflow and organize your files.

About the XMP standard

Metadata information is stored using the Extensible Metadata Platform (XMP) standard, on which Adobe Bridge, Adobe Illustrator, Adobe InDesign, and Adobe Photoshop are built. Adjustments made to images with Photoshop® Camera Raw are stored as XMP metadata. XMP is built on XML, and in most cases the metadata is stored in the file. If it isn't possible to store the information in the file, metadata is stored in a separate file called a *sidecar file*. XMP facilitates the exchange of metadata between Adobe applications and across publishing workflows. For example, you can save metadata from one file as a template, and then import the metadata into other files.

Metadata that is stored in other formats, such as Exif, IPTC (IIM), GPS, and TIFF, is synchronized and described with XMP so that it can be more easily viewed and managed. Other applications and features (for example, Adobe Version Cue) also use XMP to communicate and store information such as version comments, which you can search using Adobe Bridge.

In most cases, the metadata remains with the file even when the file format changes (for example, from PSD to JPG). Metadata also remains when files are placed in an Adobe document or project.

 *If you're a C++ or Java developer, use the XMP Toolkit SDK to customize the processing and exchange of metadata. If you're an Adobe Flash or Flex developer, use the XMP File Info SDK to customize the File Info dialog box. For more information, visit the Adobe website.*

Working with metadata in Adobe Bridge and Adobe Creative Suite components

Many of the powerful Adobe Bridge features that allow you to organize, search, and keep track of your files and versions depend on XMP metadata in your files. Adobe Bridge provides two ways of working with metadata: through the Metadata panel and through the File Info dialog box.

In some cases, multiple views exist for the same metadata property. For example, a property may be labeled Author in one view and Creator in another, but both refer to the same underlying property. Even if you customize these views for specific workflows, they remain standardized through XMP.

About notes

You can attach notes to an image in Photoshop. This is useful for associating review comments, production notes, or other information with the image. Notes appear as small non-printable icons on the image. They are associated with a location on the image rather than with a layer. You can hide or show notes, or open notes to view or edit their contents.

Add notes

You can add notes anywhere on your Photoshop image canvas. When you create a note, an icon appears on the image.

- 1 Select the Notes tool in the Tool bar or choose Window > Notes.
- 2 In the Options bar, enter or specify the following as needed:

Author Specifies the note author's name.

Color Selects the color for the note icon. Clicking the color box opens the Adobe Color Picker so you can select a color.

- 3 Click where you want to place the note.
- 4 The cursor will automatically be active

Show or hide notes

To show or hide notes, do one of the following:

- Choose View > Show > Notes.
- Choose View > Extras. This command also shows or hides grids, guides, selection edges, target paths, and slices.

Open, edit, or delete notes

To open notes:

- Click on the note icon within the image. The note text will display in the Notes panel.
- Open the Notes panel and click back arrow/forward arrow to toggle through all notes associated with the active image.

Note: From the Notes panel, you can edit the note by changing the text or delete the note by clicking the Delete Note icon.

Adding and viewing Digimarc copyright protection

Read a Digimarc watermark

- 1 Choose Filter > Digimarc > Read Watermark. If the filter finds a watermark, a dialog box displays the Digimarc ID, creator information, and image attributes.
- 2 Click OK, or for more information, click Web Lookup. The Digimarc website is displayed in your web browser, where contact details appear for the given creator ID.

Adding digital copyright information

You can add copyright information to Photoshop images and notify users that an image is copyright protected via a digital watermark that uses Digimarc ImageBridge technology. The watermark—a digital code added as noise to the image—is virtually imperceptible to the human eye. The Digimarc watermark is durable in both digital and printed forms, surviving typical image edits and file format conversions.

Embedding a digital watermark in an image lets viewers obtain information about the creator of the image. This feature is particularly valuable to image creators who license their work to others. Copying an image with an embedded watermark also copies the watermark and any information associated with it.

For more detailed information on embedding Digimarc digital watermarks, refer to the Digimarc website at www.digimarc.com.

Before adding a digital watermark

Keep in mind the following considerations before embedding a digital watermark in your image.

Color variation The image must contain some degree of variation or randomness in color to embed the digital watermark effectively and imperceptibly. The image cannot consist mostly or entirely of a single flat color.

Pixel dimensions The Digimarc technology requires a minimum number of pixels to work. Digimarc recommends the following minimum pixel dimensions for the image to be watermarked:

- 100 pixels by 100 pixels if you don't expect the image to be modified or compressed prior to its actual use.
- 256 pixels by 256 pixels if you expect the image to be cropped, rotated, compressed, or otherwise modified after watermarking.
- 750 pixels by 750 pixels if you expect the image to appear ultimately in printed form at 300 dpi or greater.

There is no upper limit on pixel dimensions for watermarking.

File compression In general, a Digimarc watermark will survive lossy compression methods, such as JPEG, though it is advisable to favor image quality over file size (a JPEG compression setting of 4 or higher works best). In addition, the higher the Watermark Durability setting you choose when embedding the watermark, the better the chances that the digital watermark will survive compression.

Workflow Digital watermarking should be one of the very last tasks you perform on an image, except for file compression.

Use the following recommended workflow:

- Make all necessary modifications to your image until you are satisfied with its final appearance (this includes resizing and color correction).
- Embed the Digimarc watermark.
- If needed, compress the image by saving it in JPEG or GIF format.
- If the image is intended for printed output, perform the color separation.
- Read the watermark and use the signal strength meter to verify that the image contains a watermark of sufficient strength for your purposes.
- Publish the digital watermarked image.

See also

[“Using the Watermark Durability setting”](#) on page 467

Embed a watermark

To embed a digital watermark, you must first register with Digimarc Corporation—which maintains a database of artists, designers, and photographers and their contact information—to get a unique Digimarc ID. You can then embed the Digimarc ID in your images, along with information such as the copyright year or a restricted-use identifier.

- 1 Open the image that you want to watermark. You can embed only one digital watermark per image. The Embed Watermark filter won't work on an image that has been previously watermarked.

If you're working with a layered image, you should flatten the image before watermarking it; otherwise, the watermark will affect the active layer only.

Note: You can add a digital watermark to an indexed-color image by first converting the image to RGB mode, embedding the watermark, and then converting the image back to Indexed Color mode. However, the results may be inconsistent. To make sure that the watermark was embedded, run the Read Watermark filter.

- 2 Choose Filter > Digimarc > Embed Watermark.
- 3 If you are using the filter for the first time, click the Personalize button. Get a Digimarc ID by clicking Info to launch your web browser and visit the Digimarc website at www.digimarc.com. Enter your PIN and ID number in the Digimarc ID text box, and click OK.

After you enter a Digimarc ID, the Personalize button becomes a Change button, allowing you to enter a new Digimarc ID.

- 4 Enter a copyright year, transaction ID, or image ID for the image.
- 5 Select any of the following image attributes:

Restricted Use Limits the use of the image.

Do Not Copy Specifies that the image should not be copied.

Adult Content Labels the image contents as suitable for adults only. (Within Photoshop, this option does not limit access to adult-only images, but future versions of other applications may limit their display.)

- 6 For Watermark Durability, drag the slider or enter a value, as described in the next section.
- 7 Select Verify to automatically assess the watermark's durability after it is embedded.
- 8 Click OK.

Using the Watermark Durability setting

The default Watermark Durability setting is designed to strike a balance between watermark durability and visibility in most images. However, you can adjust the Watermark Durability setting yourself to suit the needs of your images. Low values are less visible in an image but less durable, and may be damaged by applying filters or by performing some image editing, printing, and scanning operations. High values are more durable but may display some visible noise in the image.

Your setting should depend on the intended use of the image and the goals you've set for your watermarks. For example, it may be quite acceptable to use a higher Watermark Durability setting with JPEG images posted on a website. The higher durability helps to ensure the persistence of the watermark, and the increased visibility often is not noticeable with medium-resolution JPEG images. Digimarc recommends experimenting with various settings as part of your testing process to determine which setting works best for the majority of your images.

Check the signal strength meter

The signal strength meter helps you determine whether a watermark is durable enough to survive the intended use of the image.

- ❖ Choose Filter > Digimarc > Read Watermark. The signal strength meter appears at the bottom of the dialog box. You can also display the meter automatically by selecting Verify while embedding the watermark.

The signal strength meter is available only for images containing digital watermarks that you yourself have embedded.

Digimarc recommends that you check the signal strength meter before publishing your images. For example, if you often compress watermarked images for inclusion in a website, check the meter before posting the images. You can also use the signal strength meter to gauge the effectiveness of different Watermark Durability settings that you are experimenting with.

Placing Photoshop images in other applications

Photoshop provides a number of features to help you use images in other applications. Because of the tight integration between Adobe products, many Adobe applications can directly import Photoshop (PSD) format files and use Photoshop features like layers, layer styles, masks, transparency, and effects.

Prepare images for page-layout programs

How you prepare an image for a page-layout program depends upon the file formats the program recognizes:

- Adobe InDesign 2.0 and later can place Photoshop PSD files. You do not need to save or export your Photoshop image to a different file format. Transparent areas are displayed and printed as expected.
- Most other page-layout programs require you to save the image as a TIFF or EPS file. However, if the image contains fully transparent areas, you must first define those areas using a clipping path. Check the documentation for your page-layout program to determine the best format for importing Photoshop images.

If the page-layout program cannot place Photoshop PSD files, follow these steps:

- 1 If your image contains a transparent background or areas that you want to be transparent, create a clipping path around the opaque areas of the image. Even if you have deleted the background around the image, you must define the area with a clipping path before converting the file to TIFF or EPS format. Otherwise, areas that are transparent may appear as white in the page-layout program.
- 2 Choose File > Save As.
- 3 In the Save As dialog box, choose the appropriate format from the Format menu. The format you choose depends on the final output for the document. For printing to non-PostScript printers, choose TIFF. For printing to PostScript printers, choose Photoshop EPS. Then click Save.
- 4 In the TIFF Options or EPS Options dialog box, set the following options. Leave any remaining options at their default settings, and click OK.
 - TIFF Options dialog box: set Image Compression to None.
 - EPS Options dialog box (Windows): set Preview to TIFF (8 bits/pixel) and Encoding to ASCII85.
 - EPS Options dialog box (Mac OS): set Preview to Mac (8 bits/pixel) and Encoding to ASCII85.

 *If the layout program displays transparent areas as white, try printing the document. Some layout programs do not display clipping paths properly but print them as expected.*

Use Photoshop artwork in Adobe Illustrator

Adobe Illustrator can both open or place Photoshop files; you do not need to save or export your Photoshop image to a different file format. If you place an image into an open Illustrator file, you can incorporate the image as if it were any other element in the artwork, or you can maintain a link to the original file. Although you can't edit a linked image within Illustrator, you can jump back to Photoshop, using the Edit Original command, to revise it. Once saved, any changes you make are reflected in the version in Illustrator.

- 1 If the image file is open in Photoshop, save it as a Photoshop (PSD) file, and close the file.
- 2 In Adobe Illustrator, do one of the following:
 - To open the file directly in Illustrator, choose File > Open. Locate the image in the Open File dialog box, and click Open.
 - To incorporate the image into an existing Illustrator file, choose File > Place. Locate the file in the Place dialog box, make sure the Link option is not selected, and click Place.
 - To place the image into a file but maintain a link to the original, choose File > Place. In the Place dialog box, locate the file, select the Link option, and click Place. Illustrator centers the image in the open illustration. A red X through the image indicates it is linked and not editable.
- 3 If you opened or placed the image without linking, the Photoshop Import dialog box appears. Choose the appropriate option as follows, and click OK:
 - Convert Photoshop Layers To Objects to convert the layers to Illustrator objects. This option preserves masks, blending modes, transparency, and (optionally) slices and image maps. However, it does not support Photoshop adjustment layers and layer effects.
 - Flatten Photoshop Layers To A Single Image to merge all the layers into a single layer. This option preserves the look of the image, but you can no longer edit individual layers.

Create transparency using image clipping paths

You can use image clipping paths to define transparent areas in images you place in page-layout applications. In addition, Mac OS users can embed Photoshop images in many word-processor files.

You may want to use only part of a Photoshop image when printing it or placing it in another application. For example, you may want to use a foreground object and exclude the background. An *image clipping path* lets you isolate the foreground object and make everything else transparent when the image is printed or placed in another application.

Note: Paths are vector-based; therefore, they have hard edges. You cannot preserve the softness of a feathered edge, such as in a shadow, when creating an image clipping path.



Image imported into Illustrator or InDesign without image clipping path (left), and with image clipping path (right)

- 1 Draw a work path that defines the area of the image you want to show.

💡 If you've already selected the area of the image you want to show, you can convert the selection to a work path. See [“Convert a selection to a path”](#) on page 381 for instructions.

- 2 In the Paths panel, save the work path as a path.
- 3 Choose Clipping Path from the Paths panel menu, set the following options, and click OK:
 - For Path, choose the path you want to save.
 - For Flatness, leave the flatness value blank to print the image using the printer's default value. If you experience printing errors, enter a flatness value to determine how the PostScript interpreter approximates the curve. The lower the flatness value, the greater the number of straight lines used to draw the curve and the more accurate the curve. Values can range from 0.2 to 100. In general, a flatness setting from 8 to 10 is recommended for high-resolution printing (1200 dpi to 2400 dpi), and a setting from 1 to 3 for low-resolution printing (300 dpi to 600 dpi).
- 4 If you plan to print the file using process colors, convert the file to CMYK mode.
- 5 Save the file by doing one of the following:
 - To print the file using a PostScript printer, save in Photoshop EPS, DCS, or PDF format.
 - To print the file using a non-PostScript printer, save in TIFF format and export to Adobe InDesign, or to Adobe PageMaker® 5.0 or later.

See also

[“Prepare images for page-layout programs”](#) on page 468

[“Convert an image to another color mode”](#) on page 108

[“Drawing shapes and paths”](#) on page 359

[“Convert a selection to a path”](#) on page 381

Printing image clipping paths

Sometimes an imagesetter cannot interpret image clipping paths, or an image clipping path is too complex for a printer, resulting in a Limitcheck error or a general PostScript error. Sometimes you can print a complex path on a low-resolution printer without difficulty but run into problems when printing the same path on a high-resolution printer. This is because the lower-resolution printer simplifies the path, using fewer line segments to describe curves than the high-resolution printer does.

You can simplify an image clipping path in the following ways:

- Manually reduce the number of anchor points on the path.
- Increase the tolerance setting used to create the path. To do this, load the existing path as a selection, choose Make Work Path from the Paths panel menu, and increase the tolerance setting (4 to 6 pixels is a good starting value). Then re-create the image clipping path.

See also

[“Add or delete anchor points”](#) on page 378

[“Convert paths to selection borders”](#) on page 380

Export paths to Adobe Illustrator

The Paths To Illustrator command lets you export Photoshop paths as Adobe Illustrator files. Exporting paths in this way simplifies the task of combining Photoshop and Illustrator artwork or using Photoshop features with Illustrator artwork. For example, you may want to export a pen tool path and stroke it to use as a trap with a Photoshop clipping path you are printing in Illustrator. You can also use this feature to align Illustrator text or objects with Photoshop paths.

- 1 Draw and save a path or convert an existing selection into a path.
- 2 Choose File > Export > Paths To Illustrator.
- 3 Choose a location for the exported path, and enter a filename. Make sure Work Path is chosen from the Path menu to export the path.
- 4 Click Save.
- 5 Open the file in Adobe Illustrator. You can manipulate the path or use the path to align Illustrator objects that you add to the file.

Note that the crop marks in Adobe Illustrator reflect the dimensions of the Photoshop image. The position of the path within the Photoshop image is maintained, provided you don't change the crop marks or move the path.

Link or embed an image using OLE (Windows only)

Photoshop is an OLE 2.0 server, which means it supports embedding or linking an image in an OLE container application (usually a word-processing or page-layout program). For example, you can insert Photoshop files and selections into other OLE applications, such as Adobe PageMaker, Adobe FrameMaker, and Microsoft Word, using copy and paste or other methods.

- Linking lets you place a link in the OLE container file that refers to the Photoshop file on the hard drive.
- Embedding lets you insert the Photoshop file into the OLE container file.

After the image is in the container application, you can double-click it for editing in Photoshop. When you close the image in Photoshop, it is updated in the container application.

Link or embed a selection or image in an OLE application

- ❖ Do one of the following:
 - Copy a selection in Photoshop, and insert it in your OLE container application using the application's Paste Special command. Refer to your word-processing or page-layout application documentation for more instructions. Pasted selections can only be embedded, not linked.
 - Use your OLE container application's Insert Object command to insert a new Photoshop image or existing Photoshop file as an OLE-embedded or OLE-linked object. Refer to your word-processing or page-layout application documentation for instructions.

Insert an unlinked screen-resolution bitmap into an OLE application

- ❖ With the Move tool , drag a selection to the OLE container application. When you drop the object, it appears as a 72-ppi bitmap, which cannot be automatically updated in Photoshop.

Modify and update a linked or embedded image in an OLE application

- 1 Double-click the linked or embedded image in your word-processing or page-layout application to start Photoshop (if it is not already running), and open the image for editing.
- 2 Modify the image as desired.

3 Do one of the following:

- For embedded images, close the file, or choose File > Update or File > Close & Return to *[application name]*.
- For linked images, save and close the file.

Note: You can also modify linked files without first opening the container document. The linked image is updated the next time you open the document in its OLE container application.

Chapter 16: Printing

Printing is the process of sending your image to an output device. You can print on paper or film (positive or negative), to a printing plate, or directly to a digital printing press. Before printing, you can preview your image in full color using color management options from the Print dialog box.

Printing from Photoshop

About printing

Whether you are printing an image to your desktop printer or sending it to a prepress facility, knowing a few basics about printing makes the print job go more smoothly and helps ensure that the finished image appears as intended. Adobe® Photoshop® CS4 supports printing documents greater than 30,000 pixels, and (Mac OS only) can send 16-bit per channel data to printers.

Types of printing For many Photoshop users, printing a file means sending the image to an inkjet printer. Photoshop can send your image to a variety of devices to be printed directly onto paper or converted to a positive or negative image on film. In the latter case, you can use the film to create a master plate for printing by a mechanical press.

Types of images The simplest images, such as line art, use only one color in one level of gray. A more complex image, such as a photograph, has varying color tones. This type of image is known as a *continuous-tone image*.

Halftoning To create the illusion of continuous tones in images, printers break down images into dots. For photos printed on a printing press, this process is called *halftoning*. Varying the sizes of the dots in a halftone screen creates the optical illusion of variations of gray or continuous color in the image.

Note: Although inkjet printers also use dots to create the illusion of continuous tones, their dots are of uniform size and much smaller than the dots used by most printing presses.

Color separation Artwork intended for commercial reproduction and containing more than one color must be printed on separate master plates, one for each color. This process, called *color separation*, generally calls for the use of cyan, yellow, magenta, and black (CMYK) inks. In Photoshop, you can adjust how the various plates are generated.

Quality of detail The detail in a printed image depends on its resolution and screen frequency. The higher the resolution of an output device, the finer (higher) a screen ruling (lines per inch) you can use. Many inkjet printer drivers offer simplified print settings for higher quality printing.

About desktop printing

Unless you work in a commercial printing company or service bureau, you probably print images to a desktop printer, such as an inkjet, dye sublimation, or laser printer, not to an imagesetter. Photoshop lets you control how your image is printed.

Monitors display images using light, whereas desktop printers reproduce images using inks, dyes, or pigments. For this reason, a desktop printer can't reproduce all the colors displayed on a monitor. However, by incorporating certain procedures (such as a color management system) into your workflow, you can achieve predictable results when printing your images to a desktop printer. Keep these considerations in mind when working with an image you intend to print:

- If your image is in RGB mode, do not convert the document to CMYK mode when printing to a desktop printer. Work entirely in RGB mode. As a rule, desktop printers are configured to accept RGB data and use internal software to convert to CMYK. If you send CMYK data, most desktop printers apply a conversion anyway, with unpredictable results.
- If you want to preview an image as printed to any device for which you have a profile, use the Proof Colors command.
- To reproduce screen colors accurately on the printed page, you must incorporate color management into your workflow. Work with a monitor that is calibrated and characterized. You should also create a custom profile specifically for your printer and the paper you print on. Using the profile supplied with your printer (although better than using no profile at all) yields only mediocre results.

See also

[Printing photos video](#)

[“About soft-proofing colors”](#) on page 134

[“About color profiles”](#) on page 139

Print images

Photoshop provides the following printing commands:

Page Setup Displays options specific to your printer, printer drivers, and operating system.

Print Displays the Print dialog box, where you can preview the print job and select the printer, number of copies, output options, and color management options.

Print One Copy Prints one copy of a file without displaying a dialog box.

Set Photoshop print options and print

- 1 Choose File > Print.

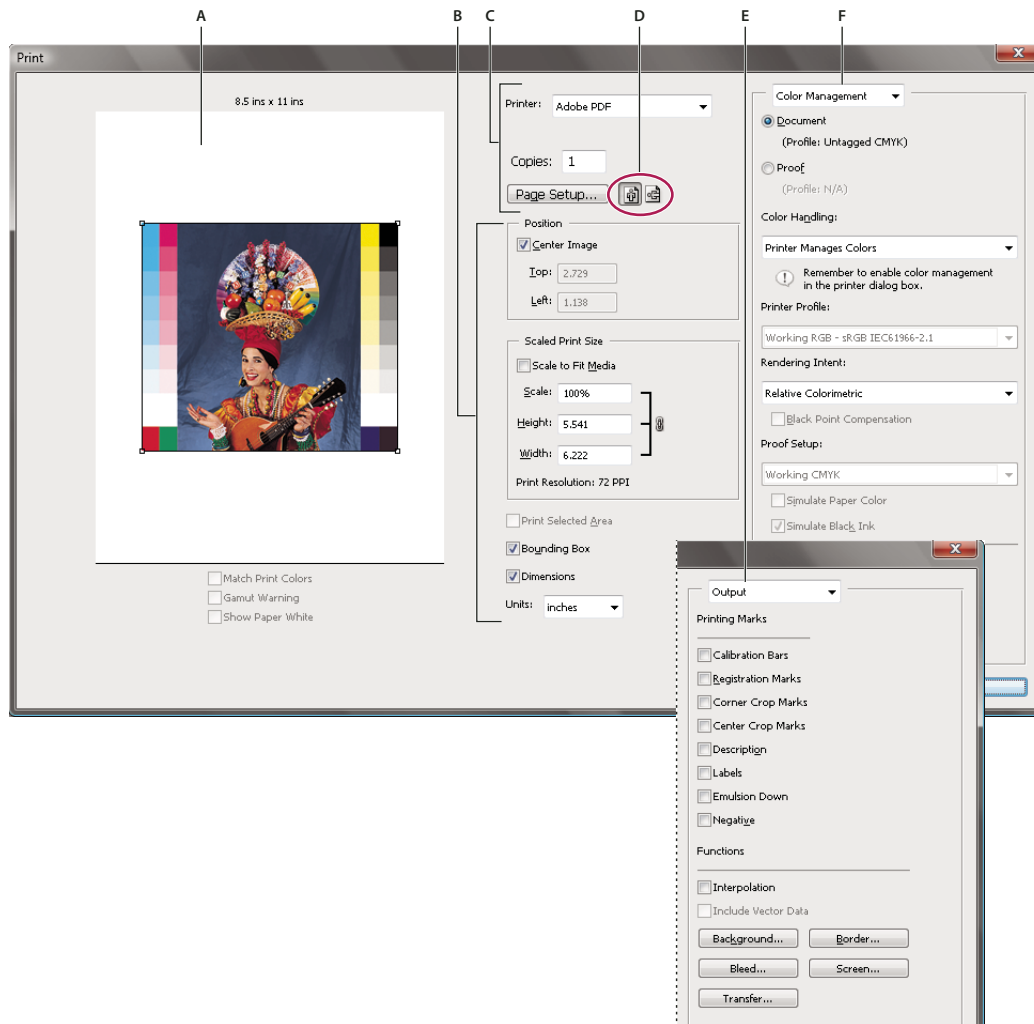

Print dialog box

A. Preview print B. Position and scale image C. Set printer and print job options D. Set paper orientation E. Specify prepress output options F. Specify color management and proofing options

For a video on printing photos, see www.adobe.com/go/vid0015.

2 Do one or more of the following:

- Use the Printers menu to select a printer.
- Set the paper orientation to portrait or landscape.
- Select the number of copies to print.
- Adjust the position and scale of the image in relation to the selected paper size and orientation. See “[Position and scale images](#)” on page 476.
- Set Output and Color Management options from the pop-up menu.

3 Do one of the following:

- To print the image, click Print.
- To close the dialog box without saving the options, click Cancel.

- To preserve the options and close the dialog box, click Done.
- To print one copy of the image, hold down Alt (Windows) or Option (Mac OS), and click Print One.

Note: If you get a warning that your image is larger than the printable area of the paper, click Cancel, choose File > Print, and select the Scale To Fit Media box. To make changes to your paper size and layout, click Page Setup, and attempt to print the file again.

Set page setup options

- 1 Choose File > Page Setup, or click Page Setup in the Print dialog box.
- 2 Set paper size, source, and page orientation as desired.

The available options depend on your printer, printer drivers, and operating system.

Note: If you plan to scale the printed image, choose File > Print and use the scaling options in the Print dialog box rather than the Page Setup dialog box. The Print dialog box is more helpful because it shows you a preview of the scaled image. Also, you don't want to set the scaling options in both the Page Setup and Print dialog boxes. This applies scaling twice, and the resulting image may not be printed at the intended size.

- 3 (Optional) In the Print dialog box, change your currently selected printer by choosing a different printer from the Printer pop-up menu.

Position and scale images

You can adjust the position and scale of an image using options in the Print dialog box. The shaded border at the edge of the paper represents the margins of the selected paper; the printable area is white.

The base output size of an image is determined by the document size settings in the Image Size dialog box. Scaling an image in the Print dialog box changes the size and resolution of the printed image only. For example, if you scale a 72-ppi image to 50% in the Print dialog box, the image will print at 144 ppi; however, the document size settings in the Image Size dialog box will not change. The Print Resolution field below the Scaled Print Size area shows the print resolution at the current scaling setting.

Many printer drivers, such as AdobePS™ and LaserWriter, provide a scaling option in the Page Setup dialog box. This scaling affects everything on the page, including the size of all page marks, such as crop marks and captions, whereas the scaling percentage provided by the Print command affects only the size of the printed image (and not the size of page marks).

Note: The Print dialog box may not reflect accurate values for Scale, Height, and Width if you set a scaling percentage in the Page Setup dialog box. To avoid inaccurate scaling, specify scaling using the Print dialog box rather than the Page Setup dialog box; do not enter a scaling percentage in both dialog boxes.

See also

[Printing photos video](#)

“[About pixel dimensions and resolution](#)” on page 56

Reposition an image on the paper

- ❖ Choose File > Print, and do one of the following:
 - To center the image in the printable area, select Center Image.
 - To position the image numerically, deselect Center Image, and then enter values for Top and Left.
 - Deselect Center Image, and drag the image in the preview area.

Scale the print size of an image

- ❖ Choose File > Print, and do one of the following:
 - To fit the image within the printable area of the selected paper, click Scale To Fit Media.
 - To rescale the image numerically, deselect Scale To Fit Media, then enter values for Height and Width.
 - To achieve the desired scale, select Bounding Box, and drag a bounding box handle in the preview area.

Print part of an image

- 1 Use the Rectangle Marquee tool to select the part of an image you want to print.
- 2 Choose File > Print, select Print Selected Area, and click Print.

Note: If you get a warning that your image is larger than the printable area of the paper, click Cancel, choose File > Print, and select the Scale To Fit Media box. To make changes to your paper size and layout, click Page Setup, and attempt to print the file again.

Print vector data

If an image includes vector graphics, such as shapes and type, Photoshop can send the vector data to a PostScript printer. When you choose to include vector data, Photoshop sends the printer a separate image for each type layer and each vector shape layer. These additional images are printed on top of the base image, and clipped using their vector outline. Consequently, the edges of vector graphics print at the printer's full resolution, even though the content of each layer is limited to the resolution of your image file.

- 1 Choose File > Print.
- 2 Choose Output from the pop-up menu.
- 3 Select the Include Vector Data option.
- 4 Click Print.

Note: If you get a warning that your image is larger than the printable area of the paper, click Cancel, choose File > Print, and select the Scale To Fit Media box. To make changes to your paper size and layout, click Page Setup, and attempt to print the file again.

Printing with color management

Let printer determine printed colors

If you don't have a custom profile for your printer and paper type, you can let the printer driver handle the color conversion. See [“Letting the printer determine colors when printing”](#) on page 137.

- 1 Choose File > Print.
- 2 Choose Color Management from the pop-up menu.

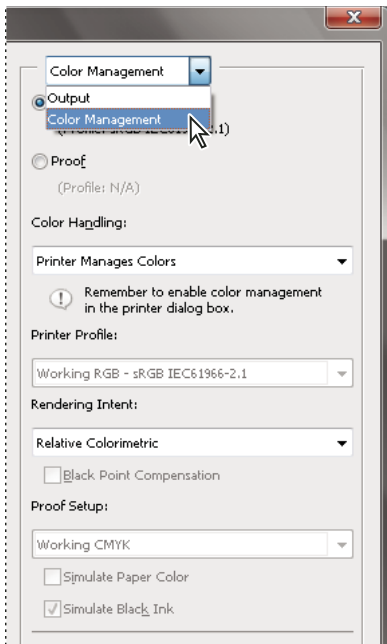

Choose Color Management to display options for prepress and color management

3 Select Document.

The profile is displayed in parentheses on the same line.

4 For Color Handling, choose Printer Manages Colors.

5 (Optional) Choose a rendering intent for converting colors to the destination color space.

Most non-PostScript printer drivers ignore this option and use the Perceptual rendering intent. (For more information, see “[About rendering intents](#)” on page 148.)

6 Access the color management options for the printer driver from the second print dialog box, which automatically appears after you click Print. In Windows, click Page Setup to access the printer driver options. In Mac OS, use the pop-up menu from the second print dialog box to access the printer driver options.

7 Specify the color management settings to let your printer driver handle the color management during printing.

Every printer driver has different color management options. If it’s not clear how to turn on color management, consult your printer documentation.

8 Click Print.

***Note:** If you get a warning that your image is larger than the printable area of the paper, and you don’t want to exceed that area, click Cancel, choose File > Print, and select the Scale To Fit Media box. To make changes to your paper size and layout, click Page Setup, and attempt to print the file again.*

Let Photoshop determine printed colors

If you have a custom color profile for a specific printer, ink, and paper combination, letting Photoshop manage colors may produce better results than letting the printer manage colors. See “[Letting the application determine colors when printing](#)” on page 138.

1 Choose File > Print.

2 Choose Color Management from the pop-up menu.

- 3 For Color Handling, choose Photoshop Manages Colors.
- 4 For Printer Profile, select the profile that best matches your output device and paper type. If there are any profiles associated with the current printer, they are placed at the top of the menu, with the default profile selected.

The more accurately the profile describes the behavior of the output device and printing conditions (such as paper type), the more accurately the color management system can translate the numeric values of the actual colors in a document. (See “[Obtaining custom profiles for desktop printers](#)” on page 138.)

- 5 (Optional) Set any of the following options.

Rendering Intent Specifies how Photoshop converts colors to the destination color space. (See “[About rendering intents](#)” on page 148.)

Black Point Compensation Preserves the shadow detail in the image by simulating the full dynamic range of the output device.

Match Print Colors Enabled when you let Photoshop manage color. Select to view image colors in the preview area as they will actually print.

Gamut Warning Enabled when Match Print Colors is selected. Select to highlight out-of-gamut colors in the image, as determined by the selected printer profile. A gamut is the range of colors that a color system can display or print. A color that can be displayed in RGB may be out of gamut for your current printer profile.

Show Paper White Sets the color white in the preview to the color of the paper in the selected printer profile. This produces a more accurate print preview if you're printing on off-white paper such as newsprint or art papers that are more beige than white. Since absolute white and black create contrast, less white in the paper will lower the overall contrast of your image. Off-white paper can also change the overall color cast of the image, so yellows printed on beige paper may appear more brown.

- 6 Access the color management options for the printer driver from the second print dialog box, which automatically appears after you click Print. In Windows, click the Preferences button to access the printer driver options. In Mac OS, use the pop-up menu from the second Print dialog box to access the printer driver options.

- 7 Turn off color management for the printer, so the printer profile settings won't override your profile settings.

Every printer driver has different color management options. If it's not clear how to turn off color management, consult your printer documentation.

- 8 Click Print.

Note: If you get a warning that your image is larger than the printable area of the paper, click Cancel, choose File > Print, and select the Scale To Fit Media box. To make changes to your paper size and layout, click Page Setup, and attempt to print the file again.

Print a hard proof

A *hard proof* (sometimes called a *proof print* or *match print*) is a printed simulation of what your final output on a printing press will look like. A hard proof is produced on an output device that's less expensive than a printing press. Some inkjet printers have the resolution necessary to produce inexpensive prints that can be used as hard proofs.

- 1 Choose View > Proof Setup, and select the output conditions you want to simulate. You can do this using a preset or by creating a custom proof setup. See “[Soft-proof colors](#)” on page 135.

The view changes automatically according to the proof you choose, unless you choose Custom. In this case, the Customize Proof Condition dialog box appears. You must save custom proof settings for them to appear in the Proof Setup Preset menu of the Print dialog box. Follow the instructions to customize a proof.

- 2 After you select a proof, choose File > Print.

3 Choose Color Management from the pop-up menu.

4 Select Proof.

The profile that appears in parentheses, should match the proof setup you selected earlier.

5 For Color Handling, choose Photoshop Manages Colors.

6 For Printer Profile, select the profile for your output device.

7 (Optional) Set any of the following options.

Proof Setup This option is available if you select Proof from the Print area. From the pop-up menu, choose any customized proofs that exist locally on your hard drive.

Simulate Paper Color Simulates what colors look like on the paper of the simulated device. Using this option produces the most accurate proof, but it is not available for all profiles.

Simulate Black Ink Simulates the brightness of dark colors for the simulated device. Using this option results in more accurate proofs of dark colors, but it is not available for all profiles.

8 Access the color management options for the printer driver from the second print dialog box, which automatically appears after you click Print. In Windows, click the Preferences button to access the printer driver options. In Mac OS, use the pop-up menu from the second print dialog box to access the printer driver options.

9 Turn off color management for the printer so that the printer profile settings don't override your profile settings.

Every printer driver has different color management options. If it's not clear how to turn off color management, consult your printer documentation.

10 Click Print.

Note: If you get a warning that your image is larger than the printable area of the paper, click Cancel, choose File > Print, and select the Scale To Fit Media box. To make changes to your paper size and layout, click Page Setup, and attempt to print the file again.

Print targets for creating custom profiles

A *target* is a document you use when creating a custom profile. Generally, a target document with swatches is supplied as part of a third-party color management software package. You print this document with all color management turned off in both Photoshop and the printer driver. The third-party measuring instrument reads or scans the printed target to create the custom profile.

1 Open the color target document in Photoshop.

2 Choose File > Print.

3 Choose Color Management from the pop-up menu.

4 Select Document.

The profile is displayed in parentheses on the same line.

5 From the Color Handling pop-up menu, choose No Color Management.

When this option is selected, Photoshop sends the RGB numbers in the file to the printer without conversion.

6 Access the color management options for the printer driver from the second print dialog box, which automatically appears after you click Print. In Windows, click the Preferences button to access the printer driver options. In Mac OS, use the pop-up menu from the second print dialog box to access the printer driver options.

7 Turn off color management for the printer so that the printer profile settings don't override your profile settings.

Every printer driver has different color management options. If it's not clear how to turn off color management, consult your printer documentation.

8 Click Print.

Note: If you get a warning that your image is larger than the printable area of the paper, click Cancel, choose File > Print, and select the Scale To Fit Media box. To make changes to your paper size and layout, click Page Setup, and attempt to print the file again.

Printing images to a commercial printing press

Preparing images for press

From Photoshop, you can prepare image files for offset lithography, digital printing, gravure, and other commercial printing processes.

Generally, your workflow depends on the capabilities of the prepress facility. Before you begin a workflow for commercial printing, contact the prepress staff to learn their requirements. For example, they may not want you to convert to CMYK at any point because they may need to use prepress-specific settings. Here are some possible scenarios for preparing your image files to achieve predictable printing results:

- Work entirely in RGB mode and make sure that the image file is tagged with the RGB working space profile. If your printer or prepress staff use a color management system, they should be able to use your file's profile to make an accurate conversion to CMYK before producing the film and printing plates.
- Work in RGB mode until you finish editing your image. Then convert the image to CMYK mode and make any additional color and tonal adjustments. Especially check the highlights and shadows of the image. Use Levels, Curves, or Hue/Saturation adjustment layers to make corrections. These adjustments should be very minor. Flatten the file if necessary, then send the CMYK file to the professional printer.
- Place your RGB or CMYK image in Adobe InDesign or Adobe Illustrator. In general, most images printed on a commercial press are not printed directly from Photoshop but from a page-layout program like Adobe InDesign or an illustration program like Adobe Illustrator. For more information on importing Photoshop files into Adobe InDesign or Adobe Illustrator, see Adobe InDesign Help or the Adobe Illustrator Help.

Here are a few issues to keep in mind when you work on an image intended for commercial printing:

- If you know the characteristics of the press, you can specify the highlight and shadow output to preserve certain details.
- If you use a desktop printer to preview the appearance of the final printed piece, keep in mind that a desktop printer cannot faithfully replicate the output of a commercial printing press. A professional color proof gives a more accurate preview of the final printed piece.
- If you have a profile from a commercial press, you can choose it with the Proof Setup command and then view a soft proof using the Proof Colors command. Use this method to preview the final printed piece on your monitor.

Note: Some printers may prefer to receive your documents in PDF format, especially if the documents need to conform to PDF/X standards. See "Save a file in Photoshop PDF format" on page 444.

See also

"Soft-proof colors" on page 135

Set output options

If you are preparing your images for commercial printing directly from Photoshop, you can select and preview a variety of page marks and other output options using the Print command. Generally, these output options should be specified only by prepress professionals or people knowledgeable about the commercial printing process.

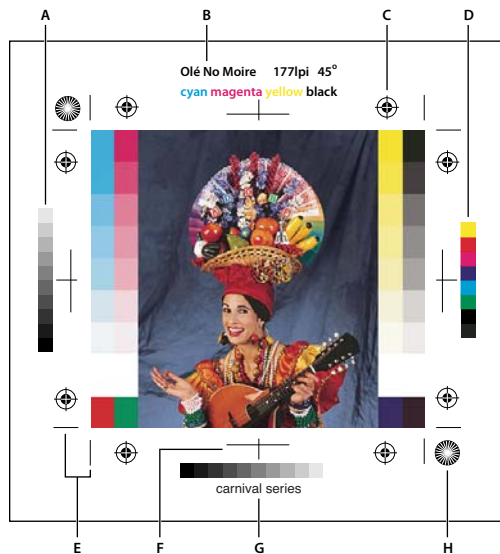

Page marks

A. Gradient tint bar **B.** Label **C.** Registration marks **D.** Progressive color bar **E.** Corner crop mark **F.** Center crop mark **G.** Description
H. Star target

- 1 Choose File > Print.
- 2 Choose Output from the pop-up menu.
- 3 Set one or more of the following options:

Calibration Bars Prints an 11-step grayscale, a transition in density from 0 to 100% in 10% increments. With a CMYK color separation, a gradient tint bar is printed to the left of each CMYK plate, and a progressive color bar to the right.

Note: Calibration bars, registration marks, crop marks, and labels are printed only if the paper is larger than the printed image.

Registration Marks Prints registration marks on the image (including bull's-eyes and star targets). These marks are used primarily for aligning color separations.

Corner Crop Marks Prints crop marks where the page is to be trimmed. You can print crop marks at the corners. On PostScript printers, selecting this option will also print star targets.

Center Crop Marks Prints crop marks where the page is to be trimmed. You can print crop marks at the center of each edge.

Description Prints any description text entered in the File Info dialog box, up to about 300 characters. Description text is always printed in 9-point Helvetica plain type.

Labels Prints the file name above the image. If printing separations, the separation name is printed as part of the label.

Emulsion Down Makes type readable when the emulsion is down—that is, when the photosensitive layer on a piece of film or photographic paper is facing away from you. Normally, images printed on paper are printed with emulsion up, with type readable when the photosensitive layer faces you. Images printed on film are often printed with emulsion down.

Negative Prints an inverted version of the entire output, including all masks and any background color. Unlike the Invert command in the Image menu, the Negative option converts the output, not the on-screen image, to a negative.

If you print separations directly to film, you probably want a negative, although in many countries film positives are common. Check with your print shop to determine which is required. To determine the emulsion side, examine the film under a bright light after it has been developed. The dull side is the emulsion; the shiny side is the base. Check whether your print shop requires film with positive emulsion up, negative emulsion up, positive emulsion down, or negative emulsion down.

Background Selects a background color to be printed on the page outside the image area. For example, a black or colored background may be desirable for slides printed to a film recorder. To use this option, click Background, and then select a color from the Color Picker. This is a printing option only; it does not affect the image itself.

Border Prints a black border around an image. Type a number and choose a unit value to specify the width of the border.

Bleed Prints crop marks inside rather than outside the image. Use this option to trim the image within the graphic. Type a number and choose a unit value to specify the width of the bleed.

Screen Sets the screen frequency and dot shape for each screen used in the printing process (for PostScript printers).

Transfer Adjusts the transfer functions, traditionally used to compensate for dot gain or dot loss that may occur when an image is transferred to film. This option is recognized only when you print to a PostScript printer. Generally, it's best to adjust for dot gain using the settings in the CMYK Setup dialog box. Transfer functions are useful, however, when compensating for a poorly calibrated output device.

Interpolation Reduces the jagged appearance of a low-resolution image by automatically resampling up while printing (on PostScript printers). Resampling may reduce the sharpness of the image quality.

Send 16-bit Data (Mac OS only) Sends 16-bit per channel data to the printer.

For information on the Include Vector Data, see “[Print vector data](#)” on page 477.

See also

“[Resampling](#)” on page 59

Selecting halftone screen attributes

Halftone screen attributes include the screen frequency and dot shape for each screen used in the printing process. For color separations, the prepress person must also specify an angle for each of the color screens. Set the screens at different angles to ensure that the dots placed by the four screens blend into continuous color and do not produce moiré patterns.

Halftone screens consist of dots that control how much ink is deposited at a specific location on press. Varying their size and density creates the illusion of variations of gray or continuous color. For a process color image, four halftone screens are used: cyan, magenta, yellow, and black—one for each ink used in the printing process.

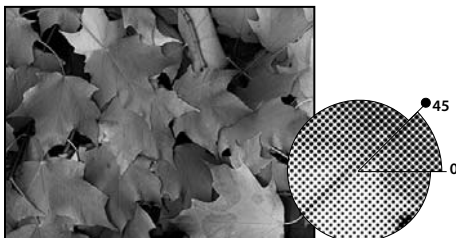

Halftone screen with black ink

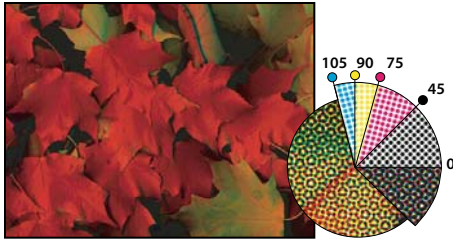

Halftone screens with process ink at different screen angles; correctly registered dots form rosettes.

In traditional print production, a halftone is produced by placing a halftone screen between a piece of film and the image and then exposing the film. In Photoshop, you specify the halftone screen attributes just before producing the film or paper output. For best results, your output device (a PostScript imagesetter, for example) should be set to the correct density limit, and your processor should be properly calibrated; otherwise, results can be unpredictable.

Before creating your halftone screens, check with your print shop for preferred frequency, angle, and dot settings. (Use the default angle settings unless your print shop specifies changes.)

Define the attributes of a halftone screen

- 1 Choose File > Print.
 - 2 Choose Output from the pop-up menu, and click Screen.
 - 3 In the Halftone Screen dialog box, choose whether to generate your own screen settings:
 - Deselect Use Printer's Default Screens to choose your own screen settings.
 - Select Use Printer's Default Screens to use the default halftone screen built into the printer. Photoshop then ignores the specifications in the Halftone Screens dialog box when it generates the halftone screens.
 - 4 For a grayscale halftone, enter a screen frequency from 1 to 999.999, and choose a unit of measurement. Enter a screen angle from -180 to +180 degrees.
 - 5 For a color separation, choose from the following options:
 - To have Photoshop determine and enter the best frequencies and angles for each screen, click Auto. In the Auto Screens dialog box, enter the resolution of the output device and the screen frequency you intend to use, and click OK. Photoshop enters the values in the Halftone Screen dialog box. Changing these values may result in moiré patterns.
 - If you are using a PostScript Level 2 (or higher) printer or an imagesetter equipped with an Emerald controller, make sure that the Use Accurate Screens option is selected in the Auto Screens dialog box (or in the Halftone Screen dialog box, if you're entering the values manually). The Use Accurate Screens option lets the program access the correct angles and halftone screen frequencies for high-resolution output. If your output device is not a PostScript Level 2 (or higher) printer or is not equipped with an Emerald controller, this option has no effect.
- Note:** Some PostScript Level 3 printers will ignore the Accurate Screens setting if the screen frequency is set too low (as determined by the printer).
- 6 For Shape, choose the dot shape you want. If you want all four screens to use the same dot shape, select Use Same Shape For All Inks.

Choosing Custom from the Shape menu displays the Custom Spot Function dialog box. You can define your own dot shapes by entering PostScript commands—useful for printing with nonstandard halftone algorithms. For information about using PostScript language commands, see the *PostScript Language Reference* published by Addison-Wesley, or consult the imagesetter's manufacturer.

For optimal output on a PostScript printer, the image resolution should be 1.5 to 2 times the halftone screen frequency. If the resolution is more than 2.5 times the screen frequency, an alert message appears. If you are printing line art or printing to a non-PostScript printer, see your printer documentation for the appropriate image resolutions to use.

7 Click OK.

See also

[“About pixel dimensions and resolution”](#) on page 56

[Printing photos video](#)

Save or load halftone screen settings

❖ In the Halftone Screen dialog box, do one of the following:

- To save settings, click Save. Choose a location for the saved settings, enter a file name, and click Save.
- To load settings, click Load. Locate and select the settings, and click Load.

Print separations from Photoshop

When preparing your image for prepress and working with CMYK images or images with spot colors, you can print each color channel as a separate page.

Note: Separations from CMYK, Duotone, or multi-channel documents printed on non-Postscript printers may not be identical to those printed on Postscript printers.

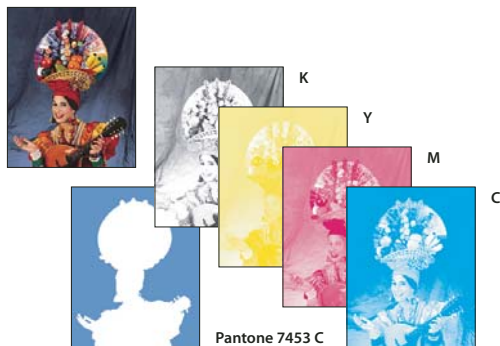

Each color channel printed as a separate page.

Note: If you are printing an image from another application and want to print spot channels to spot color plates, you must first save the file in DCS 2.0 format. DCS 2.0 preserves spot channels. This format is supported by applications such as Adobe InDesign and QuarkXPress.

- 1 Make sure that your document is in CMYK Color or Multichannel mode, and then choose File > Print.
- 2 Choose Separations from the Color Handling drop-down menu.

Note: Depending on the designated printer and printer drivers on your computer, these options may also appear in the second Print dialog box (for setting printer options). In Windows, click the Properties button to access the printer driver options; in Mac OS, use the pop-up menu in the second Print dialog box that appears.

- 3 Click Print. Separations are printed for each of the colors in the image.

See also

[“Save a file in Photoshop EPS format”](#) on page 454

[Printing photos video](#)

Prepare an image with spot channels for printing from another application

- 1 If the image is a duotone, convert it to Multichannel color mode.
- 2 Save the image in DCS 2.0 format.
- 3 In the DCS 2.0 Format dialog box, deselect the Include Halftone Screen and the Include Transfer Function options.
- 4 Open or import the image in Photoshop, and set your screen angles. Make sure that you’ve communicated to the printer the spot color you want for each of the color plates.

Note: You can place a PSD file containing spot colors directly in *Illustrator* or *InDesign* without special preparation.

See also

[“Save a file in Photoshop EPS format”](#) on page 454

Create a color trap

A *trap* is an overlap that prevents tiny gaps in the printed image caused by a slight misregistration on press. Contact your service provider before you do any trapping. In most cases, your print shop determines whether trapping is needed. If so, the print shop staff will tell you what values to enter in the Trap dialog box.

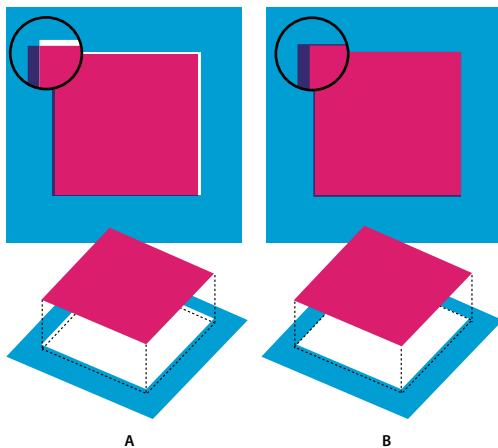

Trapping to correct misalignment
A. Misregistration with no trap B. Misregistration with trap

Trapping is intended to correct the misalignment of solid colors. In general, you don’t need traps for continuous-tone images such as photographs. Excessive trapping may produce an outline effect. These problems may not be visible on-screen and might show up only in print. Photoshop uses standard rules for trapping:

- All colors spread under black.
- Lighter colors spread under darker colors.
- Yellow spreads under cyan, magenta, and black.

- Pure cyan and pure magenta spread under each other equally.
- 1 Save a version of the file in RGB mode, in case you want to reconvert the image later. Then choose Image > Mode > CMYK Color to convert the image to CMYK mode.
 - 2 Choose Image > Trap.
 - 3 For Width, enter the trapping value provided by your print shop. Then select a unit of measurement, and click OK. Consult your print shop to determine how much misregistration to expect.

Determine scan resolution for printing

You can use a number of techniques to determine the resolution at which to scan a photograph. If you are scanning photos to be printed, and you know the exact size and the printing screen frequency, you can use the following techniques to determine the scanning resolution. Often it is easiest to scan at your scanner's maximum optical resolution and then resize the image in Photoshop later.

Estimate scan resolution

You can determine the resolution for your scan using the original and final image dimensions and the resolution of your output device. Scan resolution translates into image resolution when you open the scanned image in Photoshop.

- 1 Do one of the following:
 - For laser printers and imagesetters, multiply the printer's screen frequency by 2. To determine your printer's screen frequency, check your printer documentation or consult your service provider.
 - For inkjet printers, check your printer documentation for the optimal resolution. Many dye sublimation printers and devices that print directly onto photographic paper have an optimal resolution of 300 to 400 dpi.
- 2 Determine the ratio of the final image dimensions to the original image dimensions. For example, the ratio of a 6-by-9-inch final image to a 2-by-3-inch original image is 3:1.
- 3 Multiply the result of step 1 by the result of step 2.

For example, suppose you are printing to an imagesetter with a screen frequency of 85 lpi and the ratio of the final image to the original is 3:1. First multiply 85 (the screen frequency) by 2 to get 170. Then multiply 170 by 3 to get a scan resolution of 510 ppi. If you are printing to an inkjet printer with an optimal resolution of 300 dpi, multiply 300 by 3 to get a scan resolution of 900.

Note: Different color separation procedures might require different ratios of image resolution to screen frequency. It's a good idea to check with your service provider or print shop before you scan the image.

Calculate the file size before scanning an image

You can create a dummy file to predict the file size needed for the final output of your scan.

- 1 In Photoshop, choose File > New.
- 2 Enter the width, height, and resolution of your final printed image. The resolution should be 1.5 to 2 times the screen frequency you will use to print. Make sure that the mode you plan to scan in is selected. The New dialog box displays the file size.

For example, suppose you want the final image to be 4 inches wide and 5 inches high. You plan to print it with a 150-line screen using a 2:1 ratio, so you set the resolution to 300. The resulting file size is 5.15 MB.

To produce the scan, enter the resulting file size in your scanner settings. Don't worry about resolution or image dimensions. After you have scanned the image and imported it into Photoshop, use the Image Size command (with the Resample Image option deselected) to enter the correct width and height for the image.

Printing duotones

About duotones

You can create monotonies, duotones, tritones, and quadtones in Photoshop. Monotonies are grayscale images printed with a single, non-black ink. Duotones, tritones, and quadtones are grayscale images printed with two, three, and four inks. In these images, colored inks, rather than different shades of gray, are used to reproduce tinted grays. For the purposes of this discussion, *duotone* refers to monotonies, tritones, and quadtones as well as duotones.

Duotones increase the tonal range of a grayscale image. Although a grayscale reproduction can display up to 256 levels of gray, a printing press can reproduce only about 50 levels of gray per ink. For this reason, a grayscale image printed with only black ink can look significantly coarser than the same image printed with two, three, or four inks, each individual ink reproducing up to 50 levels of gray.

Sometimes duotones are printed using a black ink and a gray ink—the black for shadows and the gray for midtones and highlights. More frequently, duotones are printed using a colored ink for the highlight color. This technique produces an image with a slight tint and significantly increases the dynamic range of the image. Duotones are ideal for two-color print jobs with a spot color (such as a PANTONE Color) used for accent.

Because duotones use different color inks to reproduce different gray levels, they are treated in Photoshop as single-channel, 8-bit, grayscale images. In Duotone mode, you do not have direct access to the individual image channels (as in RGB, CMYK, and Lab modes). Instead, you manipulate the channels through the curves in the Duotone Options dialog box.

Convert an image to duotone

- 1 Convert the image to grayscale by choosing Image > Mode > Grayscale. Only 8-bit grayscale images can be converted to duotones.
- 2 Choose Image > Mode > Duotone.
- 3 In the Duotone Options dialog box, select Preview to preview the image.
- 4 For the Type option, select Monotone, Duotone, Tritone, or Quadtone.
- 5 Click the color box (the solid square) to open the color picker, then click the Color Libraries button and select an ink book and color from the dialog box.

Note: To produce fully saturated colors, specify inks in descending order—darkest at the top, lightest at the bottom.

- 6 Click the curve box next to the color ink box and adjust the duotone curve for each ink color.
- 7 Set overprint colors, if necessary.
- 8 Click OK.

 To apply a duotone effect to only part of an image, convert the duotone image to Multichannel mode—this converts the duotone curves to spot channels. You can then erase part of the spot channel for areas that you want printed as standard grayscale.

See also

“[About spot colors](#)” on page 491

Modify the duotone curve for a given ink

In a duotone image, each ink has a separate curve that specifies how the color is distributed across the shadows and highlights. This curve maps each grayscale value in the original image to a specific ink percentage.

- 1 To preview any adjustments, select the Preview option in the Duotones Options dialog box.
- 2 Click the curve box next to the ink color box.

The default duotone curve, a straight diagonal line, indicates that the grayscale values in the original image map to an equal percentage of ink. At this setting, a 50% midtone pixel is rendered with a 50% tint of the ink, a 100% shadow is rendered in 100% color, and so on.

- 3 Adjust the duotone curve for each ink by dragging a point on the graph or by entering values for the different ink percentages.
 - In the curve graph, the horizontal axis moves from highlights (at the left) to shadows (at the right). Ink density increases as you move up the vertical axis. You can specify up to 13 points on the curve. When you specify two values along the curve, Photoshop calculates intermediate values. As you adjust the curve, values are automatically entered in the percentage text boxes.
 - The value you enter in the text box indicates the percentage of the ink color used to represent the grayscale value in the original image. For example, if you enter 70 in the 100% text box, a 70% tint of that ink color is used to print the 100% shadows.
- 4 Click Save in the Duotone Curve dialog box to save curves created with this dialog box.
- 5 Click Load to load these curves or curves created in the Curves dialog box, including curves created using the Arbitrary Map option.

You can use the Info panel to display ink percentages when you're working with duotone images. Set the readout mode to Actual Color to determine what ink percentages will be applied when the image is printed. These values reflect any changes you've entered in the Duotone Curve dialog box.

See also

[“Curves overview”](#) on page 163

Specifying overprint colors

Overprint colors are two unscreened inks printed on top of each other. For example, when you print a cyan ink over a yellow ink, the resulting overprint color is green. The order in which inks are printed, as well as variations in the inks and paper, can significantly affect the final results.

To predict how colors will look when printed, use a printed sample of the overprinted inks and adjust your screen display accordingly. Keep in mind that this adjustment affects only how the overprint colors appear on-screen, not when printed. Before adjusting these colors, make sure to calibrate your monitor.

Adjust the display of overprint colors

- 1 Choose Image > Mode > Duotone.
- 2 Click Overprint Colors. The Overprint Colors dialog box shows how the combined inks will look when printed.
- 3 Click the color swatch of the ink combination that you want to adjust.
- 4 Select the desired color in the Color Picker, and click OK.
- 5 Repeat steps 3 and 4 until you are satisfied with the ink combination. Then click OK.

Saving and loading duotone settings

Use the Save button in the Duotone Options dialog box to save a set of duotone curves, ink settings, and overprint colors. Use the Load button to load a set of duotone curves, ink settings, and overprint colors. You can then apply these settings to other grayscale images.

Photoshop includes several sample sets of duotone, tritone, and quadtone curves. These sets include some commonly used curves and colors. Use these sets as starting points when you create your own combinations.

View the individual colors of a duotone image

Because duotones are single-channel images, your adjustments to individual printing inks are displayed as part of the final composite image. In some cases, you may want to view the individual “printing plates” to see how the individual colors will separate when printed (as you can with CMYK images).

- 1 After specifying your ink colors, choose Image > Mode > Multichannel.

The image is converted to Multichannel mode, with each channel represented as a spot color channel. The contents of each spot channel accurately reflect the duotone settings, but the on-screen composite preview may not be as accurate as the preview in Duotone mode.

Note: If you make any changes to the image in Multichannel mode, you can't revert to the original duotone state (unless you can access the duotone state in the History panel). To adjust the distribution of ink and view its effect on the individual printing plates, make the adjustments in the Duotone Curves dialog box before converting to Multichannel mode.

- 2 Select the channel you want to examine in the Channels panel.
- 3 Choose Edit > Undo Multichannel to revert to Duotone mode.

Printing duotones

When creating duotones, keep in mind that both the order in which the inks are printed and the screen angles you use have a significant effect on the final output.

Click the Auto button in the Halftone Screen dialog box to set the optimal screen angles and frequencies (choose File > Print, then choose Output from the pop-up menu and click Screen). Be sure to select Use Accurate Screens in the Auto Screens dialog box, if you're printing to a PostScript Level 2 (or higher) printer or an imagesetter equipped with an Emerald controller.

Note: The recommended screen angles and frequencies for quadtones are based on the assumption that channel 1 is the darkest ink and channel 4 is the lightest ink.

You do not have to convert duotone images to CMYK to print separations—simply choose Separations from the Profile pop-up menu in the Color Management section of the Print dialog box (for setting printer options). Converting to CMYK mode converts any custom colors to their CMYK equivalents.

Exporting duotone images to other applications

To export a duotone image to a page-layout application, you must first save the image in EPS or PDF format. (However, if the image contains spot channels, convert it to Multichannel mode and save it in DCS 2.0 format.) Remember to name custom colors using the appropriate suffix so that the importing application can recognize them. Otherwise, the application may not print the colors correctly, or it may not print the image at all.

Printing spot colors

About spot colors

Spot colors are special premixed inks used instead of, or in addition to, the process color (CMYK) inks. Each spot color requires its own plate on the press. (Because a varnish requires a separate plate, it is considered a spot color, too.)

If you are planning to print an image with spot colors, you need to create spot channels to store the colors. To export spot channels, save the file in DCS 2.0 format or PDF.

Note the following when working with spot colors:

- For spot color graphics that have crisp edges and knock out the underlying image, consider creating the additional artwork in a page layout or illustration application.
- To apply spot color as a tint throughout an image, convert the image to Duotone mode and apply the spot color to one of the duotone plates. You can use up to four spot colors, one per plate.
- The names of the spot colors are printed on the separations.
- Spot colors are overprinted on top of the fully composited image. Each spot color is printed in the order it appears in the Channels panel, with the topmost channel printing as the topmost spot color.
- You cannot move spot colors above a default channel in the Channels panel except in Multichannel mode.
- Spot colors cannot be applied to individual layers.
- Printing an image with a spot color channel to a composite color printer will print the spot color at an opacity indicated by the Solidity setting.
- You can merge spot channels with color channels, splitting the spot color into its color channel components.

See also

[“About channels”](#) on page 265

[“Print separations from Photoshop”](#) on page 485

Create a new spot channel

You can create a new spot channel or convert an existing alpha channel to a spot channel.

- 1 Choose Window > Channels to display the Channels panel.
- 2 To fill a selected area with a spot color, make or load a selection.
- 3 Do one of the following to create a channel:
 - Ctrl-click (Windows) or Command-click (Mac OS) the New Channel button  in the Channels panel.
 - Choose New Spot Channel from the Channels panel menu.

If you made a selection, that area is filled with the currently specified spot color.

- 4 In the New Spot Channel dialog box, click the Color box. Then in the Color Picker, click Color Libraries to choose from a custom color system such as PANTONE or TOYO and choose a color. See [“Choose a spot color”](#) on page 119.



If you select a custom color, your print service provider can more easily provide the proper ink to reproduce the image.

- 5 Enter a name for the spot channel. If you choose a custom color, the channel automatically takes the name of that color.

Be sure to name spot colors so they'll be recognized by other applications reading your file. Otherwise the file might not print.

- 6 For Solidity, enter a value between 0% and 100%.

This option lets you simulate on-screen the density of the printed spot color. A value of 100% simulates an ink that completely covers the inks beneath (such as a metallic ink); 0% simulates a transparent ink that completely reveals the inks beneath (such as a clear varnish). You can also use this option to see where an otherwise transparent spot color (such as a varnish) will appear.



Solidity at 100% and solidity at 50%.

Note: The Solidity and color choice options affect only the on-screen preview and the composite print. They have no effect on the printed separations.

See also

[“Choose a spot color”](#) on page 119

Convert an alpha channel to a spot channel

- 1 Do one of the following:
 - Double-click the alpha channel thumbnail in the Channels panel.
 - Select the alpha channel in the Channels panel, and choose Channel Options from the panel menu.
- 2 Select Spot Color.
- 3 Click the color box, then choose a color in the Color Picker or click Color Libraries and choose a custom color. Click OK.
- 4 Rename the channel if needed.
- 5 Click OK.

The areas of the channel containing grayscale values are converted to spot color.

- 6 To apply the color to the selected area of the channel, choose Image > Adjustments > Invert.

See also

[“Create a new spot channel”](#) on page 491

Edit a spot channel to add or remove color

- 1 Select the spot channel in the Channels panel.
- 2 Use a painting or editing tool to paint in the image. Paint with black to add more spot color at 100% opacity; paint with gray to add spot color with lower opacity.

Note: Unlike the Solidity option in the Spot Channel Options dialog box, the Opacity option in the painting or editing tool's options determines the actual density of ink used in the printed output.

Change a spot channel's color or solidity

- 1 Double-click the spot channel thumbnail in the Channels panel.
- 2 Click the color box, and choose a color. Click Color Libraries to choose from a custom color system such as PANTONE or TOYO.
- 3 Enter a Solidity value between 0% and 100% to adjust ink opacity for the spot color.

See also

[“Create a new spot channel”](#) on page 491

[“Choose a spot color”](#) on page 119

Merge spot channels

- 1 Select the spot channel in the Channels panel.
- 2 Choose Merge Spot Channel from the panel menu.

The spot color is converted to and merged with the color channels. The spot channel is deleted from the panel.

Merging spot channels flattens layered images. The merged composite reflects the preview spot color information, including the Solidity settings. For example, a spot channel with a solidity of 50% will produce different merged results than the same channel with a solidity of 100%.

In addition, the resulting merged spot channels usually don't reproduce the same colors as the original spot channels, because CMYK inks can't represent the range of colors available from spot color inks.

Adjust overlapping spot colors

To prevent overlapping spot colors from either printing over or knocking out the underlying spot color, remove one of the spot colors where they overlap.

Use a printed sample of the overprinted inks to adjust your screen display to help you predict how colors will look when printed.

Note: In some cases, such as when you use varnish and bump plates, you may want colors to overprint.

- 1 In the Channels panel, select the spot channel with the color you want to print.
- 2 Choose Select > Load Selection.

 To quickly select an image in a channel, hold down Ctrl (Windows) or Command (Mac OS), and click the channel in the Channels panel.

- 3 For Channel, choose the spot channel from step 1, and click OK.

- 4 To create a trap when knocking out the underlying color, choose **Select > Modify > Expand** or **Contract**, depending on whether the overlapping spot color is darker or lighter than the spot color beneath it. In the Channels panel, select the underlying spot channel that contains the areas you want to knock out. Press **Backspace** (Windows) or **Delete** (Mac OS).



This method can be used to knock out areas from any channels under a spot color, such as the CMYK channels.

- 5 If a spot color in one channel overlaps more than one other spot color, repeat this process for each channel that contains the areas you want removed.

See also

[“Create a color trap”](#) on page 486

Chapter 17: Web graphics

The web tools in Adobe Photoshop CS4 can help you design and optimize individual web graphics or complete page layouts.

Working with web graphics

About web graphics

The Photoshop web tools make it easy to build component pieces for your web pages or to output complete web pages in preset or customized formats.

- Use layers and slices to design web pages and web page interface elements.
- Use layer comps to experiment with different page compositions or to export variations of a page.
- Create rollover text or button graphics to import into Dreamweaver or Flash.
- Create web animations with the Animation panel, then export them as animated GIF images or QuickTime files. See “[Creating frame animations](#)” on page 547.
- Use Adobe Bridge to create a web photo gallery to quickly turn a set of images into an interactive web site, using a variety of professional-looking templates.

For a video on designing web sites with Photoshop and Dreamweaver, see www.adobe.com/go/vid0200.

Creating rollovers

A *rollover* is a button or image on a web page that changes when the mouse is over it. To create a rollover, you need at least two images: a primary image for the normal state and a secondary image for the changed state.

Photoshop provides a number of useful tools for creating rollover images:

- Use layers to create primary and secondary images. Create content on one layer, then duplicate the layer and edit it to create similar content while maintaining alignment between layers. When creating a rollover effect, you can change the layer’s style, visibility or position, make color or tonal adjustments, or apply filter effects. See “[Duplicate layers](#)” on page 282.
- You can also use layer styles to apply effects, such as color overlays, drop shadows, glow, or emboss, to the primary layer. To create a rollover pair, turn the layer style on or off and save the image in each state. See “[Layer effects and styles](#)” on page 298.
- Use preset button styles from the Styles panel to quickly create rollover buttons with normal, mouseover, and mousedown states. Draw a basic shape with the rectangle tool and apply a style, such as Beveled Normal, to automatically turn the rectangle into a button. Then copy the layer and apply other preset styles, like Beveled Mouseover, to create additional button states. Save each layer as a separate image to create a finished rollover button set.
- Use the Save For Web & Devices dialog box to save rollover images in a web-compatible format and with an optimized file size. See “[Optimizing images](#)” on page 506.



When you save rollover images, use a naming convention to distinguish the primary (non-rollover state) image from the secondary (rollover state) image.

After creating a rollover image set in Photoshop, use Dreamweaver to place the images on a web page and automatically add the JavaScript code for the rollover action.

For a video on designing web sites with Photoshop and Dreamweaver, see www.adobe.com/go/vid0200.

Export to Zoomify

You can post high-resolution images on the web that viewers can pan and zoom to see more detail. The basic-size image downloads in the same time as an equivalent size JPEG file. Photoshop exports the JPEG files and HTML file that you can upload to your web server.

1 Choose File > Export > Zoomify and set export options.

Template Sets the background and navigation for the image viewed in the browser.

Output Location Specifies the location and name of the file.

Image Tile Options Specifies the quality of the image.

Browser Options Sets the pixel width and height for the base image in the viewer's browser.

2 Upload the HTML and image files to your web server.

For a video on Zoomify, see www.adobe.com/go/vid0003.

Working with hexadecimal color values

Photoshop can display the hexadecimal values of image colors or copy a color's hexadecimal value for use in an HTML file.

See also

“Choose web-safe colors” on page 118

View hexadecimal color values in the Info panel:

1 Choose Window > Info or click the Info panel tab to view the panel.

2 Choose Panel Options from the panel menu. Under First Color Readout or Second Color Readout, choose Web Color from the Mode menu and click OK.

3 Position the pointer over the color for which you want to view hexadecimal values.

Copy a color as a hexadecimal value

You can copy the current foreground color or a color in an image as a hexadecimal value while in the main work area (not the Save For Web & Devices dialog box).

1 Copy the color by doing one of the following:

- Set the foreground color using the Color panel, the Swatches panel, or the Adobe Color Picker. Choose Copy Color As HTML from the Color panel menu.
- With the Eyedropper tool selected, move the pointer over the color that you want to copy, and then right-click (Windows) or Control-click (Mac OS) and choose Copy Color As HTML from the context menu

The color is copied to the clipboard as the HTML COLOR attribute with the hexadecimal value (color=#xxyyzz).

2 To paste the color into an HTML file, open the target file in an HTML editing application and choose Edit > Paste.

Slicing web pages

About sliced web pages

Slices divide an image into smaller images that are reassembled on a web page using an HTML table or CSS layers. By dividing the image, you can assign different URL links to create page navigation, or optimize each part of an image using its own optimization settings.

You export and optimize a sliced image using the Save For Web & Devices command. Photoshop saves each slice as a separate file and generates the HTML or CSS code needed to display the sliced image.



Web page divided into slices.

When you work with slices, keep these basics in mind:

- You can create a slice by using the Slice tool or by creating layer-based slices.
- After you create a slice, you can select it using the Slice Select tool  and then move, resize, or align it with other slices.
- You can set options for each slice—such as slice type, name, and URL—in the Slice Options dialog box.
- You can optimize each slice using different optimization settings in the Save For Web & Devices dialog box.

Slice types

Slices are categorized by their content type (Table, Image, No Image) and by the way they are created (user, layer-based, auto).

Slices created with the Slice tool are called *user slices*; slices created from a layer are called *layer-based slices*. When you create a new user slice or layer-based slice, additional *auto slices* are generated to account for the remaining areas of the image. In other words, auto slices fill the space in the image that is not defined by user slices or layer-based slices. Auto slices are regenerated every time you add or edit user slices or layer-based slices. You can convert auto slices to user slices.

User slices, layer-based slices, and auto slices look different—user slices and layer-based slices are defined by a solid line, whereas auto slices are defined by a dotted line. In addition, user slices and layer-based slices display a distinct icon. You can choose to show or hide auto slices, which can make your work with user-slices and layer-based slices easier to view.

A *subslice* is a type of auto slice that is generated when you create overlapping slices. Subslices indicate how the image is divided when you save the optimized file. Although subslices are numbered and display a slice symbol, you cannot select or edit them separately from the underlying slice. Subslices are regenerated every time you arrange the stacking order of slices.

Slices are created using different methods:

- Auto slices are automatically generated.
- User slices are created with the Slice tool.
- Layer-based slices are created with the Layers panel.

See also

[“Specify a slice content type”](#) on page 504

Slice a web page

You can use the slice tool to draw slice lines directly on an image, or design your graphic using layers, and then create slices based on the layers.

Create a slice with the Slice tool

- 1 Select the Slice tool . Any existing slices automatically appear in the document window.
- 2 Choose a style setting in the options bar:

Normal Determines slice proportions as you drag.

Fixed Aspect Ratio Sets a height-to-width ratio. Enter whole numbers or decimals for the aspect ratio. For example, to create a slice twice as wide as it is high, enter 2 for the width and 1 for the height.

Fixed Size Specifies the slice’s height and width. Enter pixel values in whole numbers.

- 3 Drag over the area where you want to create a slice. Shift-drag to constrain the slice to a square. Alt-drag (Windows) or Option-drag (Mac OS) to draw from the center. Use View > Snap To to align a new slice to a guide or another slice in the image. See [“Move, resize, and snap user slices”](#) on page 500.

Create slices from guides

- 1 Add guides to an image.
- 2 Select the Slice tool, and click Slices From Guides in the options bar.

When you create slices from guides, any existing slices are deleted.

Create a slice from a layer

A layer-based slice encompasses all the pixel data in the layer. If you move the layer or edit the layer’s content, the slice area automatically adjusts to include the new pixels.

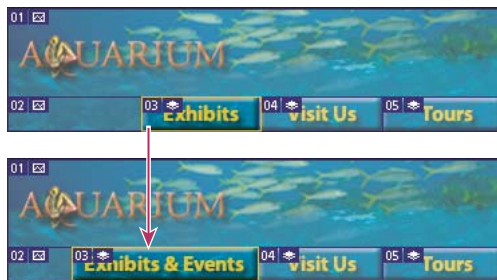

A layer-based slice is updated when the source layer is modified.

Layer-based slices are less flexible than user slices; however, you can convert (“promote”) a layer-based slice to a user slice. See “[Convert auto and layer-based slices to user slices](#)” on page 499.

- 1 Select a layer in the Layers panel.
- 2 Choose Layer > New Layer-based Slice.

 *Don’t use a layer-based slice when you plan to move the layer over a large area of the image during an animation, because the slice dimension may exceed a useful size.*

Convert auto and layer-based slices to user slices

A layer-based slice is tied to the pixel content of a layer, so the only way to move, combine, divide, resize, and align it is to edit the layer—unless you convert it to a user slice.

All auto slices in an image are linked and share the same optimization settings. If you want to set different optimization settings for an auto slice, you need to promote it to a user slice.

- 1 Using the Slice Select tool, select one or more slices to convert.
- 2 Click Promote in the options bar.

 *You can promote an auto slice in the Save For Web & Devices dialog box by unlinking it. See “[Work with slices in the Save For Web & Devices dialog box](#)” on page 510*

View slices and slice options

You can view slices in Photoshop and the Save For Web & Devices dialog box. The following characteristics can help you identify and differentiate between slices:

Slice lines Define the boundary of the slice. Solid lines indicate that the slice is a user slice or layer-based slice; dotted lines indicate that the slice is an auto slice.



Slice colors Differentiate user slices and layer-based slices from auto slices. By default, user slices and layer-based slices have blue symbols, and auto slices have gray symbols.

In addition, the Save For Web & Devices dialog box uses color adjustments to dim unselected slices. These adjustments are for display purposes only and do not affect the color of the final image. By default, the color adjustment for auto slices is twice the amount of that for user slices.

Slice numbers Slices are numbered **01** from left to right and top to bottom, beginning in the upper-left corner of the image. If you change the arrangement or total number of slices, slice numbers are updated to reflect the new order.

Slice badges The following *badges*, or icons, indicate certain conditions.

-  User slice has Image content.

-  User slice has No Image content.
-  Slice is layer-based.

Show or hide slice boundaries

- ❖ Choose View > Show > Slices. To hide and show slices along with other items, use the Extras command. See “[Show or hide Extras](#)” on page 40.

Show or hide auto slices

- ❖ Do one of the following:
 - Select the Slice Select tool, and click Show Auto Slices or Hide Auto Slices in the options bar.
 - Choose View > Show > Slices. Auto slices appear with the rest of your slices.

Show or hide slice numbers

- 1 Do one of the following:
 - In Windows, choose Edit > Preferences > Guides, Grid & Slices.
 - In Mac OS, choose Photoshop > Preferences > Guides, Grid & Slices.
- 2 Under Slices, click Show Slice Numbers.

Change the color of slice lines

- 1 In Windows, choose Edit > Preferences > Guides, Grid & Slices; in Mac OS, choose Photoshop > Preferences > Guides, Grid & Slices.
- 2 Under Slice Lines, choose a color from the Line Color menu.

After the color change, selected slice lines are automatically displayed in a contrasting color.

Modifying slices

Select one or more slices

Do one of the following:

- Select the Slice Select tool  and click the slice in the image. When working with overlapping slices, click the visible section of an underlying slice to select it.
- Select the Slice Select tool, and Shift-click to add slices to the selection.
- Select the Slice Select tool in the Save for Web & Devices dialog box, and click in an auto slice or outside the image area, and drag across the slices you want to select. (Clicking in a user slice and dragging moves the slice.)
- Choose File > Save For Web & Devices. In the dialog box, use the Slice tool to select a slice.

 *When using either the Slice tool or the Slice Select tool, you can switch from one tool to the other by holding down Ctrl (Windows) or Command (Mac OS).*

Move, resize, and snap user slices

You can move and resize user slices in Photoshop, but not in the Save For Web & Devices dialog box.

Move or resize a user slice

- 1 Select one or more user slices.
- 2 Do one of the following:
 - To move a slice, move the pointer inside the slice selection border, and drag the slice to a new position. Press Shift to restrict movement to a vertical, horizontal, or 45° diagonal line.
 - To resize a slice, grab a side or a corner handle of the slice, and drag. If you select and resize adjacent slices, common edges shared by the slices are resized together.

Resize or move a user slice using numeric coordinates

- 1 Select one or more user slices.
 - 2 Click the Options button in the options bar. You can also double-click a slice to show the options.
 - 3 In the Dimensions area of the Slice Options dialog box, change one or more of the following options:
 - X** Specifies the distance in pixels between the left edge of the slice and the origin of the ruler in the document window.
 - Y** Specifies the distance in pixels between the top edge of the slice and the origin of the ruler in the document window.
- Note: The default origin of the ruler is the upper-left corner of the image.*
- W** Specifies the width of the slice.
 - H** Specifies the height of the slice.

Snap slices to a guide, user slice, or other object

- 1 Select the options you want from the View > Snap To submenu.
- 2 Choose View > Snap. A check mark indicates that the option is turned on.
- 3 Move your selected slices as desired. The slices snap to any of your chosen objects within 4 pixels.

Divide user slices and auto slices

Use the Divide Slice dialog box to divide slices horizontally, vertically, or both. Divided slices are always user slices, regardless of whether the original is a user slice or an auto slice.

Note: You cannot divide layer-based slices.

- 1 Select one or more slices.
- 2 With the Slice Select tool selected, click Divide in the options bar.
- 3 Select Preview in the Divide Slice dialog box to preview the changes.
- 4 In the Divide Slice dialog box, select one or both of the following options:

Divide Horizontally Into Divides the slice lengthwise.

Divide Vertically Into Divides the slice widthwise.

- 5 Define how you want to divide each selected slice:
 - Select and enter a value for Slices Down or Slices Across to divide each slice evenly into the specified number of slices.

- Select and enter a value for Pixels Per Slice to create slices with the specified number of pixels. If the slice cannot be divided evenly by that number of pixels, the remainder is made into another slice. For example, if you divide a slice that is 100 pixels wide into three new slices each 30 pixels wide, the remaining 10-pixel-wide area becomes a new slice.
- 6 Click OK.

Duplicate slices

You can create a duplicate slice with the same dimensions and optimization settings as the original. If the original slice is a linked user slice, the duplicate is linked to the same collection of linked slices. Duplicate slices are always user slices, regardless of whether the original is a user slice, a layer-based slice, or an auto slice.

- 1 Select a slice or multiple slices.
- 2 Alt-drag (Windows) or Option-drag (Mac OS) from inside the selection.

Copy and paste a slice

You can copy and paste a selected slice within an image, into another image, or into another application such as Dreamweaver. Copying a slice copies all layers within the bounds of the slice (not just the active layer).

- 1 Select one or more slices with the Slice Select tool.
- 2 Choose Edit > Copy.

Note: A slice can't be copied if there is an active selection in the document (a marquee pixel selection or a selected path).

- 3 Do one of the following:
 - If you want to paste the slice into another image, open and display that image.
 - If pasting into Dreamweaver, make your Dreamweaver document the active window.
- 4 Choose Edit > Paste. A new layer is created when a slice is pasted into a Photoshop image.

Note: A slice copied into Dreamweaver retains information about the filename and path of the original Photoshop source file. To view this information in Dreamweaver, right-click (Windows) or Ctrl+click (Mac OS) the image and choose Design Notes, then locate the FilePathSrc field on the All Info tab.

For a video on designing web sites with Photoshop and Dreamweaver, see www.adobe.com/go/vid0200.

Combine slices

You can combine two or more slices into a single slice. Photoshop determines the dimensions and position of the resulting slice from the rectangle created by joining the outer edges of the combined slices. If the combined slices are not adjacent or have different proportions or alignments, the newly combined slice may overlap other slices.

The combined slice takes the optimization settings of the first slice in the series of slices you select. A combined slice is always a user slice, regardless of whether the original slices include auto slices.

Note: You cannot combine layer-based slices.

- 1 Select two or more slices.
- 2 Right-click (Windows) or Ctrl-click (Mac OS) and choose Combine Slices.

Change the stacking order of slices

When slices overlap, the last slice you create is the top slice in the stacking order. You can change the stacking order to gain access to underlying slices. You can specify which slice is on the top and bottom of the stack and move slices up or down in the stacking order.

Note: You cannot arrange the stacking order of auto slices.

- 1 Select a slice or multiple slices.
- 2 Choose the Slice Select tool, and click a stacking order option in the options bar.

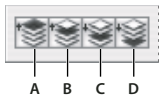

Stacking order options

A. Bring To Front B. Bring Forward C. Send Backward D. Send To Back

Align and distribute user slices

You can align user slices along an edge or their centers, and distribute user slices evenly along the vertical or horizontal axis. By aligning and distributing user slices, you can eliminate unneeded auto slices and generate a smaller, more efficient HTML file.

Note: To align or distribute layer-based slices, align or distribute the contents of the layers.

- 1 Select the user slices you want to align.
- 2 Choose the Slice Select tool, and select a option in the options bar.

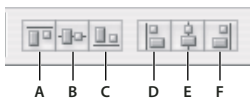

Alignment options

A. Top B. Vertical Centers C. Bottom D. Left E. Horizontal Centers F. Right



Distribute options

A. Top B. Vertical Centers C. Bottom D. Left E. Horizontal Centers F. Right

See also

“[Align objects on different layers](#)” on page 287

Delete a slice

When you delete a user slice or layer-based slice, auto slices are regenerated to fill the document area.

Deleting a layer-based slice does not delete the associated layer; however, deleting the layer associated with a layer-based slice does delete the layer-based slice.

Note: You cannot delete auto slices. If you delete all user slices and layer-based slices in an image, one auto slice covering the entire image remains.

- 1 Select one or more slices.
- 2 Choose the Slice or Slice Select tool and press the Backspace key or the Delete key.

- 3 To delete all user slices and layer-based slices, choose View > Clear Slices.

Lock all slices

Locking slices prevents you from resizing, moving, or otherwise changing them accidentally.

- ❖ Choose View > Lock Slice.

Slice output options

Display the Slice Options dialog box

Do one of the following:

- Double-click a slice with the Slice Select tool.
- With the Slice Select tool active, click the Slice Options button  in the options bar. This method is not in the Save For Web & Devices dialog box.

Specify a slice content type

You can specify how the slice data appears in a web browser when exported with an HTML file. The available options vary according to the slice type you select.

- Image slices contain image data. This is the default content type.
- No Image slices let you create empty table cells that can be populated with text or a solid color. You can enter HTML text in a No Image slice. If you set the “Text is HTML” option in the Save for Web & Devices dialog box, the text is interpreted as HTML when viewed in a browser. Slices of type No Image aren’t exported as images and can be previewed in a browser.

Note: Setting options for an auto slice promotes the slice to a user slice.

- 1 Select a slice. If you are working in Photoshop, double-click the slice with the Slice Select tool to display the Slice Options dialog box.
- 2 In the Slice Options dialog box, select a slice type from the Type pop-up menu.

Rename a slice

As you add slices to an image, you may find it helpful to rename slices based on their content. By default, user slices are named according to the settings in the Output Options dialog box. Layer-based slices are given the name of the layer from which they are derived.

- ❖ Select a slice and double-click the slice with the Slice Select tool to display the Slice Options dialog box. In the Slice Options dialog box, type a new name in the Name text box.

Note: The Name text box is not available for No Image slice content.

Choose a background color for a slice

You can select a background color to fill the transparent area (for Image slices) or entire area (for No Image slices) of the slice.

Photoshop does not display the selected background color—you must preview the image in a browser to view the effect of selecting a background color.

- 1 Select a slice. If you are working in the Photoshop Save For Web & Devices dialog box, double-click the slice with the Slice Select tool to display the Slice Options dialog box.
- 2 In the Slice Options dialog box, select a background color from the Background Color pop-up menu. Select None, Matte, White, Black, or Other (using the Adobe Color Picker).

Assign URL link information to an Image slice

Assigning a URL to a slice makes the entire slice area a link in the resulting web page. When a user clicks the link, the web browser navigates to the specified URL and target frame. This option is available only for Image slices.

- 1 Select a slice. If you are working in Photoshop, double-click the slice with the Slice Select tool to display the Slice Options dialog box.
- 2 In the Slice Options dialog box, enter a URL in the URL text box. You can enter a relative URL or absolute (full) URL. If you enter an absolute URL, be sure to include the proper protocol (for example, <http://www.adobe.com>, not www.adobe.com). For more information on using relative and full URLs, see an HTML reference.
- 3 If desired, enter the name of a target frame in the Target text box:

_blank Displays the linked file in a new window, leaving the original browser window open.

_self Displays the linked file in the same frame as the original file.

_parent Displays the linked file in its own original parent frameset. Use this option if the HTML document contains frames and the current frame is a child. The linked file appears in the current parent frame.

_top Replaces the entire browser window with the linked file, removing all current frames. The name must match a frame name previously defined in the HTML file for the document. When a user clicks the link, the specified file appears in the new frame.

Note: For more information on frames, see an HTML reference.

Specify browser messages and Alt text

You can specify what messages appear in the browser. These options are available only for Image slices and appear only in exported HTML files.

- 1 Select a slice. If you are working in Photoshop, double-click the slice with the Slice Select tool to display the Slice Options dialog box.
- 2 In the Slice Options dialog box, type the desired text.

Message Text Changes the default message in the browser's status area for a selected slice or slices. By default, the slice's URL, if any, is displayed.

Alt Tag/Alt Specifies an Alt tag for a selected slice or slices. The Alt text appears in place of the slice image in nongraphical browsers. It also appears in place of the image while the image is downloading and as a tool tip in some browsers.

Add HTML text to a slice

When you choose a slice of type No Image, you can enter text to be displayed in the slice area of the resulting web page. This can be plain text or text formatted with standard HTML tags. You can also select vertical and horizontal alignment options. For more information on specific HTML tags, see an HTML reference.

Photoshop does not display HTML text in the document window; you must use a web browser to preview the text. Be sure to preview HTML text in different browsers, with different browser settings, and on different operating systems to confirm that your text is displayed correctly on the web.

Note: The amount of text in a No Image slice can affect the layout of an exported page.

- 1 Select a slice. Double-click the slice with the Slice Select tool to display the Slice Options dialog box. You can double-click the slice in the Save For Web & Devices dialog box to set additional formatting options.
- 2 In the Slice Options dialog box, select No Image from the Slice Type menu.
- 3 Type the desired text in the text box.
- 4 (Save For Web & Devices dialog box only) If the text includes HTML formatting tags, select the Text Is HTML option. If you don't select this option, HTML tags are ignored and all text appears as unformatted plain text on the resulting web page.
- 5 (Save For Web & Devices dialog box only) If desired, select options in the Cell Alignment section of the dialog box:

Default Uses the browser's default for horizontal alignment.

Left Aligns the text to the left side of the slice area.

Center Aligns the text to the center of the slice area.

Right Aligns the text to the right side of the slice area.

Default Uses the browser's default for vertical alignment.

Top Aligns the text to the top of the slice area.

Baseline Sets a common baseline for the first line of text in cells in the same row (of the resulting HTML table). Each cell in the row must use the Baseline option.

Middle Centers the text vertically in the slice area.

Bottom Aligns the text to the bottom of the slice area.

See also

[“Preview optimized images in a web browser”](#) on page 512

Optimizing images

About optimization

When preparing images for the web and other online media, you often need to compromise between image display quality and the file size of the image.

Save for Web & Devices

You can use the optimization features in the Save For Web & Devices dialog box to preview optimized images in different file formats and with different file attributes. You can view multiple versions of an image simultaneously and modify optimization settings as you preview the image to select the best combination of settings for your needs. You can also specify transparency and matting, select options to control dithering, and resize the image to specified pixel dimensions or a specified percentage of the original size.

When you save an optimized file using the Save For Web & Devices command, you can choose to generate an HTML file for the image. This file contains all the necessary information to display your image in a web browser.

Photoshop Save As and Image Processor

In Photoshop, you can use the Save As command to save an image as a GIF, JPEG, or PNG file. Depending on the file format, you can specify image quality, background transparency or matting, color display, and downloading method. However, any web features—such as slices, links, and animations—that you’ve added to a file are not preserved.

You can also use the Photoshop Image Processor to save copies of a folder of images in JPEG format. You can use the Image Processor to resize and convert the images’ color profile to web standard sRGB.

Save For Web & Devices overview

You use the Save For Web & Devices dialog box (File > Save For Web & Devices) to select optimization options and preview optimized artwork.

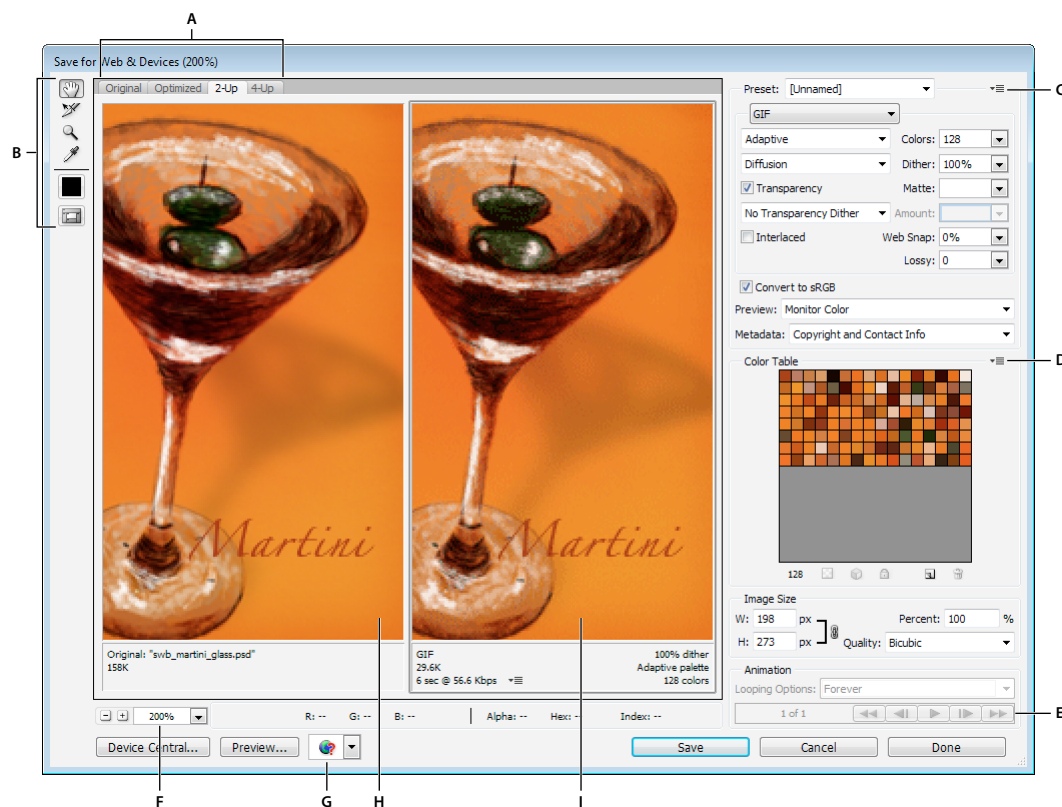

Save For Web & Devices dialog box
 A. Display options B. Toolbox C. Optimize pop-up menu D. Color Table pop-up menu E. Animation controls (Photoshop only) F. Zoom text box G. Preview In Browser menu H. Original image I. Optimized image

Preview images in the dialog box

❖ Click a tab at the top of the image area to select a display option:

Original Displays the image with no optimization.

Optimized Displays image with the current optimization settings applied.

2-Up Displays two versions of the image side by side.

4-Up Displays four versions of the image side by side.

Navigate in the dialog box

If the entire artwork is not visible in the Save For Web & Devices dialog box, you can use the Hand tool to bring another area into view. Use the Zoom tool to magnify or reduce the view.

- Select the Hand tool (or hold down the spacebar), and drag in the view area to pan over the image.
- Select the Zoom tool , and click in a view to zoom in; hold down Alt (Windows) or Option (Mac OS), and click in a view to zoom out.

You can also type a magnification percentage or choose one at the bottom of the dialog box.

View optimized image information and download time

The annotation area below each image in the Save For Web & Devices dialog box provides optimization information. The annotation for the original image shows the file name and file size. The annotation for the optimized image shows the current optimization options, the size of the optimized file, and the estimated download time using the selected modem speed. You can choose a modem speed in the Preview pop-up menu.

Preview image gamma at different values

The gamma value of a computer monitor affects how light or dark an image looks in a web browser. Windows systems use a gamma of 2.2, so images look darker on Windows than on Mac OS systems, which are normally set to a gamma of 1.8. In Photoshop, you can preview how your images will look on systems with different gamma values and make gamma adjustments to the image to compensate. Activating a preview option does not affect final image output.

- ❖ Choose one of the following options by using the Save for Web/ & Devices dialog box Preview pop-up menu

Monitor Color Makes no adjustments to image gamma. Monitor Color is the default setting.

Macintosh (No Color Management) Displays an adjustment based on the default Macintosh gamma.

Windows (No Color Management) Displays an adjustment based on the default Windows gamma.

Use Document Profile Adjusts the gamma to match any attached document color profile in a color-managed document.

Optimize an image for the web

- 1 Choose File > Save For Web & Devices.
- 2 Click a tab at the top of the dialog box to select a display option: Optimized, 2-Up, or 4-Up. If you select 4-Up, click the preview you want to optimize.
- 3 (Optional) If your image contains multiple slices, select one or more slices you want to optimize.
- 4 Select a preset optimization setting from the Preset menu, or set individual optimization options. The available options change depending on the file format you select.

 *If you're working in 4-Up mode, choose Repopulate Views from the Optimize menu to automatically generate lower-quality versions of the image after you change the optimization settings.*

- 5 Fine-tune the optimization settings until you are satisfied with the balance of image quality and file size. If your image contains multiple slices, be sure to optimize all the slices.

 *To restore an optimized preview to the original version, select it and then choose Original from the Preset menu.*

- 6 If optimizing an image with an embedded color profile other than sRGB, you should convert the image's colors to sRGB before you save the image for use on the web. This insures that the colors you see in the optimized image will look the same in different web browsers. The Convert to sRGB option is selected by default.
- 7 (Photoshop only) From the Metadata menu, choose what XMP metadata to save with the optimized file. Metadata is fully supported by JPEG file format, and partially supported by GIF and PNG file formats. It can include any metadata file information that was added to the document (choose File > File Info to view or enter document metadata).

None No metadata saved. Produces the smallest file size.

Copyright Saves copyright notice, rights usage terms, copyright status, and copyright info URL.

Copyright and Contact Info Saves all copyright information, plus the following information: creator, creator job title, e-mail(s), address, city, state/province, postal code, country, telephone(s), and website(s).

All Except Camera Info Saves all XMP metadata, except EXIF data. EXIF data includes camera settings and scene information such as shutter speed, date and time, focal length, exposure compensation, metering pattern, and whether a flash was used.

All Saves all XMP metadata in the file.

8 Click Save.

9 In the Save Optimized As dialog box, do the following, and then click Save:

- Enter a file name, and select a location for the resulting file or files.
- Select a Format option to specify what kind of files you want to save: an HTML file and image files, only image files, or only an HTML file.
- (Optional) Set output settings for HTML and image files.
- If your image contains multiple slices, select an option for saving slices from the Slices menu: All Slices or Selected Slices.

 *To reset optimization settings to the last saved version, press Alt (Windows) or Option (Mac OS), and click Reset. To keep the same settings the next time you open the Save For Web & Devices dialog box, press Alt/Option and click Remember.*

For a video on saving files for the web in Illustrator, see www.adobe.com/go/vid0063.

See also

[Save for web in Illustrator video](#)

[“Web graphics optimization options”](#) on page 512

[“Preview optimized images in a web browser”](#) on page 512

[“Set output options”](#) on page 524

Save or delete optimization presets

You can save optimization settings as a named set and apply the settings to other images. Settings that you save appear in the Preset pop-up menu, together with the predefined named settings. If you edit a named set or a predefined set, the Preset menu displays the term “Unnamed.”

- 1 Set optimization options as desired, and choose Save Settings from the Optimize palette menu.

2 Name the settings, and save them in the appropriate folder:

Photoshop (Windows XP) Document and Settings\[Username]\Application Data\Adobe\Adobe Photoshop CS4\Optimized Settings

(Windows Vista) Users\[Username]\AppData\Roaming\Adobe\Adobe Photoshop CS4\Optimized Settings

(Mac OS) User/[Username]/Library/Preferences/Adobe Photoshop CS4 Settings/Optimized Settings

Illustrator (Windows XP) Document and Settings\[Username]\Application Data\Adobe\Adobe Illustrator CS4 Settings\[Language]\Save for Web Settings\Optimize

(Windows Vista) Users\[Username]\AppData\Roaming\Adobe\Adobe Illustrator CS4 Settings\[Language]\Save for Web Settings\Optimize



(Mac OS) User/[Username]/Library/ApplicationSupport/Adobe/Adobe Illustrator CS4/[Language]/Save for Web Settings/Optimize

Note: If you save the settings in a another location, they will not be available from the Preset pop-up menu.



3 To delete a preset, select the preset from Preset menu, and select Delete Settings from the Optimize menu.

Work with slices in the Save For Web & Devices dialog box

If your image contains multiple slices, you must specify the slices to be optimized. You can apply optimization settings to additional slices by linking the slices. Linked slices in GIF and PNG-8 format share a color palette and dither pattern to prevent the appearance of seams between the slices.

- To show or hide all slices, click the Toggle Slices Visibility button .
- (Photoshop only) To show or hide auto slices, choose Hide Auto Slices from the Preview pop-up menu.
- To select slices in the Save For Web & Devices dialog box, choose the Slice Select tool , and then click a slice to select it. Shift-click or Shift-drag to select multiple slices.

Note: In the Save For Web & Devices dialog box, unselected slices are dimmed. This does not affect the color of the final image.

- To view slice options in the Save For Web & Devices dialog box, select the Slice Select tool, and double-click a slice.
- To link slices, select two or more slices and choose Link Slices from the Optimize pop-up menu  (to the right of the Preset menu). The link icon  appears on the linked slices.
- To unlink a slice, select the slice, and then choose Unlink Slice from the Optimize pop-up menu.
- To unlink all slices in an image, choose Unlink All Slices from the Optimize pop-up menu.

Compress a web graphic to a specific file size

- 1 Choose File > Save For Web & Devices.
- 2 Click a tab at the top of the Save For Web & Devices dialog box to select a display option: Optimized, 2-Up, or 4-Up. If you select 4-Up, select the preview you want to optimize.
- 3 (Optional) Select the slices you want to optimize and the file format you want to use.
- 4 Select Optimize To File Size from the Optimize menu (to the right of the Settings menu).
- 5 Enter the desired file size.
- 6 Select a Start With option:

Current Settings Uses the current file format.

Auto Select GIF/JPEG Automatically selects the optimal format depending on image content.

- 7 Select a Use option to specify whether you want to apply the specified file size to current slice only, to each slice in the image, or to all slices. Click OK.

Resize artwork while optimizing

In the Save For Web & Devices dialog box, you can resize an image to specified pixel dimensions or to a percentage of the original size.

- 1 Click the Image Size tab in the Save For Web & Devices dialog box.

- 2 Set any of the additional options:

Constrain Proportions Maintains the current proportions of pixel width to pixel height.

Quality (Photoshop only) Specifies the interpolation method. Bicubic Sharper generally produces better results when you are reducing image size.

Anti-Alias (Illustrator only) Removes jagged edges in the artwork by applying anti-aliasing.

Clip To Artboard (Illustrator only) Clips the artwork size to match the document's Artboard boundary. Any artwork outside the Artboard boundary will be deleted.

Note: None of the features in the Image Size palette are available for the SWF and SVG file formats except Clip To Artboard.

- 3 Enter new pixel dimensions or specify a percentage by which to resize the image, and click Apply.

Generate CSS layers for web graphics

You can use layers in your Illustrator artwork to generate CSS layers in the resulting HTML file. A CSS layer is an element that has an absolute position and can overlap with other elements in a web page. Exporting CSS layers is useful when you plan to create dynamic effects in your web page.

The Layers palette in the Save For Web & Devices dialog box gives you control over which top-level layers in your artwork are exported as CSS layers, and whether exported layers are visible or hidden.

- 1 Click the Layers tab in the Save For Web & Devices dialog box.
- 2 Select Export As CSS Layers.
- 3 Select a layer from the Layer pop-up menu, and set the following options as desired:

Visible Creates a visible CSS layer in the resulting HTML file.

Hidden Creates a hidden CSS layer in the resulting HTML file.



CSS layers are the same as GoLive layers. Using Adobe GoLive, you can animate a CSS layer and use built-in JavaScript actions to create interactive effects.

See also

[“Save For Web & Devices overview”](#) on page 507

[“Optimize an image for the web”](#) on page 508

Preview optimized images in a web browser

You can preview an optimized image in any web browser installed on your system from the Save For Web & Devices dialog box (File > Save For Web & Devices). The browser preview displays the image with a caption listing the image's file type, pixel dimensions, file size, compression specifications, and other HTML information.

- To preview an image in your default web browser, click the browser icon at the bottom of the Save For Web & Devices dialog box.
- To select a different browser, select Other from the browser pop-up menu (next to the browser icon).
- To add, edit, or remove a browser in the browser pop-up menu, select Edit List from the browser pop-up menu. In the Browsers dialog box, you can find all browsers on your computer and set the default browser to preview your image.

Save a file to e-mail

- 1 Open the image in Photoshop, and choose File > Save For Web & Devices.
- 2 Click the Optimized tab at the top of the Save For Web & Devices dialog box.
- 3 Choose JPEG Low from the Preset menu.
- 4 Click the Image Size tab.
- 5 Make sure that Constrain Proportions is selected and enter a width. For e-mail, 400 pixels is a good size. Use a smaller size if your recipient has a slow Internet connection.
- 6 Click Save. Enter a file name and location in which to save the file. Under Format, make sure that Images Only is selected. Click Save.

Now you are ready to e-mail the file. In some e-mail programs, you can drag the file into the body of the message. In other programs, you use the Attach or Insert command.

Web graphics optimization options

Web graphic formats

Web graphics formats can be either bitmap (raster) or vector. The bitmap formats—GIF, JPEG, PNG, and WBMP—are *resolution-dependent*, meaning that a bitmap image's dimensions, and possibly image quality, will change at different monitor resolutions. The vector formats—SVG and SWF—are *resolution-independent* and can be scaled up or down without losing any image quality. The vector formats can also include raster data. You can export from Save For Web & Devices to SVG and SWF in Adobe Illustrator only.

JPEG optimization options

JPEG is the standard format for compressing continuous-tone images such as photographs. Optimizing an image as a JPEG format relies on *lossy* compression, which selectively discards data.

Note: Since image data is lost when saving a file in JPEG format, it's a good idea to save the source file in its original format (for example, Photoshop .PSD) if you plan to edit the file further or create additional JPEG versions.

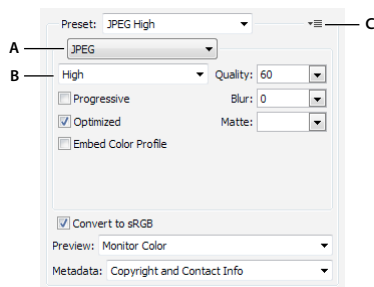

Optimization settings for JPEG
A. File Format menu B. Compression Quality menu C. Optimize menu

Quality Determines the level of compression. The higher the Quality setting, the more detail the compression algorithm preserves. However, using a high Quality setting results in a larger file size than using a low Quality setting. View the optimized image at several quality settings to determine the best balance of quality and file size.

Optimized Creates an enhanced JPEG with a slightly smaller file size. The Optimized JPEG format is recommended for maximum file compression; however, some older browsers do not support this feature.

Progressive Displays the image progressively in a web browser. The image appears as a series of overlays, enabling viewers to see a low-resolution version of the image before it downloads completely. The Progressive option requires use of the Optimized JPEG format.

Note: Progressive JPEGs require more RAM for viewing and are not supported by some browsers.

Blur Specifies the amount of blur to apply to the image. This option applies an effect identical to that of the Gaussian Blur filter and allows the file to be compressed more, resulting in a smaller file size. A setting of 0.1 to 0.5 is recommended.

Embed Color Profile (Photoshop) or ICC Profile (Illustrator) Preserves color profiles in the optimized file. Some browsers use color profiles for color correction.

Matte Specifies a fill color for pixels that were transparent in the original image. Click the Matte color swatch to select a color in the color picker, or select an option from the Matte menu: Eyedropper Color (to use the color in the eyedropper sample box), Foreground Color, Background Color, White, Black, or Other (to use the color picker).

Note: The Foreground Color and Background Color options are only available in Photoshop.

Pixels that were fully transparent in the original image are filled with the selected color; pixels that were partially transparent in the original image are blended with the selected color.

See also

[“Optimize an image for the web”](#) on page 508

GIF and PNG-8 optimization options

GIF is the standard format for compressing images with flat color and crisp detail, such as line art, logos, or illustrations with type. Like the GIF format, the PNG-8 format efficiently compresses solid areas of color while preserving sharp detail.

PNG-8 and GIF files support 8-bit color, so they can display up to 256 colors. The process of determining which colors to use is called *indexing*, so images in GIF and PNG-8 formats are sometimes called *indexed color* images. To convert an image to indexed color, a color lookup table is built to store and index the colors in the image. If a color in the original image does not appear in the color lookup table, the application either chooses the closest color in the table or simulates the color using a combination of available colors.

In addition to the following options, you can also adjust the number of colors in the image's color table. See “Customize the color table for GIF and PNG-8 images” on page 517.

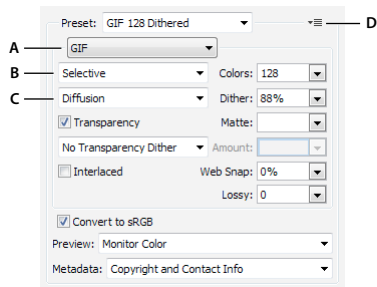

Optimization settings for GIF

A. File Format menu B. Color Reduction Algorithm menu C. Dithering Algorithm menu D. Optimize menu

Lossy (GIF only) Reduces file size by selectively discarding data. A higher Lossy setting results in more data being discarded. You can often apply a Lossy value of 5–10, and sometimes up to 50, without degrading the image. The Lossy option can reduce file size by 5% to 40%.

Note: You cannot use the Lossy option with the Interlaced option or with Noise or Pattern Dither algorithms.

Color Reduction Method and Colors Specifies a method for generating the color lookup table and the number of colors you want in the color lookup table. You can select one of the following color reduction methods:

- **Perceptual** Creates a custom color table by giving priority to colors for which the human eye has greater sensitivity.
- **Selective** Creates a color table similar to the Perceptual color table, but favoring broad areas of color and the preservation of web colors. This color table usually produces images with the greatest color integrity. Selective is the default option.
- **Adaptive** Creates a custom color table by sampling colors from the predominant spectrum in the image. For example, an image with only the colors green and blue produces a color table made primarily of greens and blues. Most images concentrate colors in particular areas of the spectrum.
- **Restrictive (Web)** Uses the standard 216-color color table common to the Windows and Mac OS 8-bit (256-color) palettes. This option ensures that no browser dither is applied to colors when the image is displayed using 8-bit color. (This palette is also called the web-safe palette.) Using the web palette can create larger files, and is recommended only when avoiding browser dither is a high priority.
- **Custom** Uses a color palette that is created or modified by the user. If you open an existing GIF or PNG-8 file, it will have a custom color palette.



Use the Color Table palette in the Save For Web & Devices dialog box to customize the color lookup table.

- **Black and White, Grayscale, Mac OS, Windows** Use a set palette of colors.

Dithering Method and Dither Determines the method and amount of application dithering. Dithering refers to the method of simulating colors not available in the color display system of your computer. A higher dithering percentage creates the appearance of more colors and more detail in an image, but can also increase the file size. For optimal compression, use the lowest percentage of dither that provides the color detail you require. Images with primarily solid colors may work well with no dither. Images with continuous-tone color (especially color gradients) may require dithering to prevent color banding.

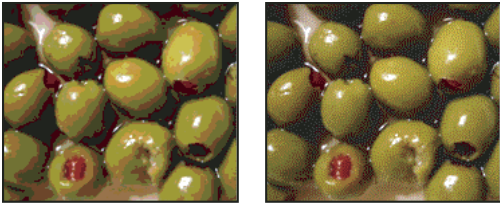

GIF image with 0% dither (left), and with 100% dither (right)

You can select one of the following dithering methods:

- **Diffusion** Applies a random pattern that is usually less noticeable than Pattern dither. The dither effects are diffused across adjacent pixels.
- **Pattern** Applies a halftone-like square pattern to simulate any colors not in the color table.
- **Noise** Applies a random pattern similar to the Diffusion dither method, but without diffusing the pattern across adjacent pixels. No seams appear with the Noise dither method.

Transparency and Matte Determines how transparent pixels in the image are optimized.

- To make fully transparent pixels transparent and blend partially transparent pixels with a color, select Transparency and select a matte color.
- To fill fully transparent pixels with a color and blend partially transparent pixels with the same color, select a matte color and deselect Transparency.
- To select a matte color, click the Matte color swatch and select a color in the color picker. Alternatively, select an option from the Matte menu: Eyedropper Color (to use the color in the eyedropper sample box), Foreground Color, Background Color, White, Black, or Other (to use the color picker).

Note: The Foreground Color and Background Color options are only available in Photoshop.

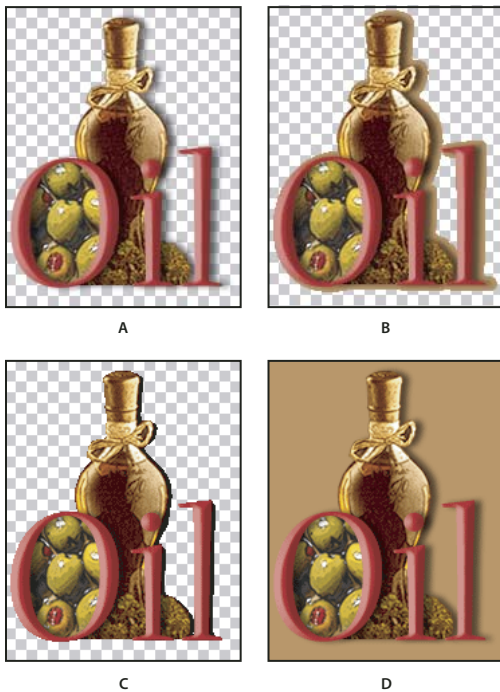

Examples of transparency and matting

A. Original image B. Transparency selected with a matte color C. Transparency selected with no matting D. Transparency deselected with a matte color

Transparency Dithering When the Transparency option is selected, you can choose a method for dithering partially transparent pixels:

- No Transparency Dither applies no dither to partially transparent pixels in the image.
- Diffusion Transparency Dither applies a random pattern that is usually less noticeable than Pattern dither. The dither effects are diffused across adjacent pixels. If you select this algorithm, specify a Dither percentage to control the amount of dithering that is applied to the image.
- Pattern Transparency Dither applies a halftone-like square pattern to partially transparent pixels.
- Noise Transparency Dither applies a random pattern similar to the Diffusion algorithm, but without diffusing the pattern across adjacent pixels. No seams appear with the Noise algorithm.

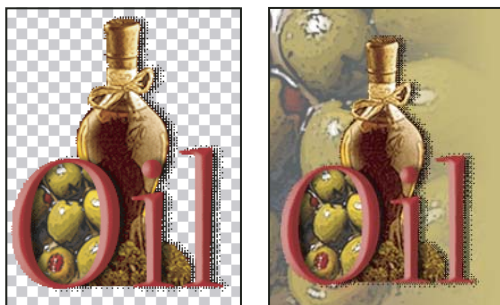

Example of Pattern Transparency dithering (left) and applied to a web page background (right)

Interlace Displays a low-resolution version of the image in a browser while the full image file is downloading. Interlacing can make downloading time seem shorter and can assure viewers that downloading is in progress. However, interlacing also increases file size.

Web Snap Specifies a tolerance level for shifting colors to the closest web palette equivalents (and prevent the colors from dithering in a browser). A higher value shifts more colors.

See also

“[Optimize an image for the web](#)” on page 508

Optimize transparency in GIF and PNG images

Transparency makes it possible to create nonrectangular images for the web. *Background transparency* preserves transparent pixels in the image. This allows the background of the web page to show through the transparent areas of your image. *Background matting* simulates transparency by filling or blending transparent pixels with a matte color that can match the web page background. Background matting works best if the web page background is a solid color and if you know what that color is.

Use the Transparency and Matte options in the Save For Web & Devices dialog box to specify how transparent pixels in GIF and PNG images are optimized.

- (GIF and PNG-8) To make fully transparent pixels transparent and blend partially transparent pixels with a color, select Transparency and select a matte color.
- To fill fully transparent pixels with a color and blend partially transparent pixels with the same color, select a matte color and deselect Transparency.
- (GIF and PNG-8) To make all pixels with greater than 50% transparency fully transparent and all pixels with 50% or less transparency fully opaque, select Transparency and select None from the Matte menu.
- (PNG-24) To save an image with multilevel transparency (up to 256 levels), select Transparency. The Matte option is disabled since multilevel transparency allows an image to blend with any background color.

Note: *In browsers that do not support PNG-24 transparency, transparent pixels may be displayed against a default background color, such as gray.*

To select a matte color, click the Matte color swatch and select a color in the color picker. Alternatively, select an option from the Matte menu: Eyedropper Color (to use the color in the eyedropper sample box), Foreground Color, Background Color, White, Black, or Other (to use the color picker).

Note: *The Foreground Color and Background Color options are only available in Photoshop.*

View the color table for an optimized slice

The color table for a slice appears in the Color Table panel in the Save For Web & Devices dialog box.

- ❖ Select a slice that is optimized in GIF or PNG-8 format. The color table for the selected slice appears in the Save For Web & Devices color table.

If an image has multiple slices, the colors in the color table may vary between slices (you can link the slices first to prevent this from happening). If you select multiple slices that use different color tables, the color table is empty and its status bar displays the message “Mixed.”

Customize the color table for GIF and PNG-8 images

You use the color table in the Save For Web & Devices dialog box to customize the colors in optimized GIF and PNG-8 images. Reducing the number of colors often preserves image quality while reducing the file size of the image.

You can add and delete colors in the color table, shift selected colors to web-safe colors, and lock selected colors to prevent them from being dropped from the palette.

Sort a color table

Choose a sorting order from the Color Table palette menu:

- Unsorted restores the original sorting order.
- Sort By Hue sorts by the location of the color on the standard color wheel (expressed as a degree from 0 to 360). Neutral colors are assigned a hue of 0 and located with the reds.
- Sort By Luminance sorts by the lightness or brightness of a color.
- Sort By Popularity sorts by the colors' frequency of occurrence in the image.

Add a new color to the color table

You can add colors that were left out in building the color table. Adding a color to a dynamic table shifts the color in the palette closest to the new color. Adding a color to a fixed or Custom table adds an additional color to the palette.

- 1 If any colors are currently selected in the color table, choose Deselect All Colors from the Color Table palette menu to deselect them.
- 2 Choose a color by doing one of the following:
 - Click the Eyedropper Color box in the Save For Web & Devices dialog box and choose a color from the color picker.
 - Select the Eyedropper tool in the Save For Web & Devices dialog box and click in the image.
- 3 Do one of the following:
 - Click the New Color button  in the color table.
 - Select New Color from the Color Table palette menu.



To switch the color table to a Custom palette, hold down Ctrl (Windows) or Command (Mac OS) when you add the new color.

The new color appears in the color table with a small white square in the lower right corner, indicating that the color is locked. If the color table is dynamic, the original color is displayed in the upper left and the new color is displayed in the lower right.

Select colors in the color table

A white border appears around selected colors in the Color Table.

- To select a color, click the color in the Color Table.
- To select multiple colors in the color table, press Shift and click another color. All colors in the rows between the first and second selected colors are selected. To select a nonadjacent group of colors, press Ctrl (Windows) or Command (Mac OS) and click each color that you want to select. The Color Table palette menu also provides commands for selecting colors.
- To select a color in the preview image, click in the preview with the Save For Web & Devices Eyedropper tool. Shift-click to select additional colors.
- To deselect all colors, choose Deselect All Colors from the Color Table palette menu.

Shift a color

You can change a selected color in the color table to any other RGB color value. When you regenerate the optimized image, the selected color changes to the new color wherever it appears in the image.

- 1 Double-click the color in the color table to display the default color picker.
- 2 Select a color.

The original color appears at the upper left of the color swatch and the new color at the lower right. The small square at the lower right of the color swatch indicates that the color is locked. If you shift to a web-safe color, a small white diamond appears at the center of the swatch.

3 To revert a shifted color to its original color, do one of the following:

- Double-click the swatch for the shifted color. The original color is selected in the color picker. Click OK to restore the color.
- To revert all shifted colors in a color table (including web-shifted colors), choose Unshift All Colors from the Color Table palette menu.

Shift colors to the closest web palette equivalent

To protect colors from dithering in a browser, you can shift the colors to their closest equivalents in the web palette. This ensures that the colors won't dither when displayed in browsers on either Windows or Macintosh operating systems capable of displaying only 256 colors.

1 Select one or more colors in the optimized image or color table.

2 Do one of the following:

- Click the Web Shift button  in the Color Table palette.
- Choose Shift/Unshift Selected Colors To/From Web Palette from the Color Table palette menu. The original color appears at the upper left of the color swatch and the new color at the lower right. The small white diamond  in the center of the color swatch indicates that the color is web-safe; the small square at the lower right of the color swatch indicates that the color is locked.

3 To set a tolerance for shifting, enter a value for Web Snap. A higher value shifts more colors.

4 To revert web-shifted colors, do one of the following:

- Select a web-shifted color in the color table and click the Web Shift button  in the Color Table palette.
- To revert all web-shifted colors in the color table, choose Unshift All Colors from the Color Table palette menu.

Map colors to transparency

You can add transparency to an optimized image by mapping existing colors to transparency.

1 Select one or more colors in the optimized image or color table.

2 Do one of the following:

- Click the Map Transparency button  in the Color Table palette.
- Choose Map/Unmap Selected Colors To/From Transparent from the Color Table palette menu.

The transparency grid  appears in half of each mapped color. The small square at the lower right of the color swatch indicates that the color is locked.

3 To revert transparency to original color, do one of the following:

- Select the colors you want to revert and click the Map Transparency button  or choose Map/Unmap Selected Colors To/From Transparent from the Color Table palette menu.
- To revert all transparency-mapped colors, choose Unmap All Transparent Colors.

Lock or unlock a color

You can lock selected colors in the color table to prevent them from being dropped when the number of colors is reduced and to prevent them from dithering in the application.

Note: Locking colors does not prevent them from dithering in a browser.

- 1 Select one or more colors in the color table.
- 2 Lock the color by doing one of the following:
 - Click the Lock button .
 - Choose Lock/Unlock Selected Colors from the Color Table palette menu.

A white square  appears in the lower right corner of each locked color.

- 3 Unlock the color by doing one of the following:
 - Click the Lock button .
 - Choose Lock/Unlock Selected Colors from the Color Table palette menu.

The white square disappears from the color swatch.

Delete selected colors

You can delete selected colors from the color table to decrease the image file size. When you delete a color, areas of the optimized image that previously included that color are re-rendered using the closest color remaining in the palette.

When you delete a color, the color table automatically changes to a Custom palette. This is because the Adaptive, Perceptual, and Selective palettes automatically add the deleted color back into the palette when you reoptimize the image—the Custom palette does not change when you reoptimize the image.

- 1 Select one or more colors in the color table.
- 2 Delete the color by doing one of the following:
 - Click the Delete icon .
 - Choose Delete Color from the Color Table palette menu.

Save a color table

You can save color tables from optimized images to use with other images and to load color tables created in other applications. Once you load a new color table into an image, the colors in the optimized image are changed to reflect the colors in the new color table.

- 1 Select Save Color Table from the Color Table palette menu.
- 2 Name the color table and choose a location where it will be saved. By default, the color table file is given the extension .act (for Adobe Color Table).

If you want to access the color table when selecting Optimization options for a GIF or PNG image, save the color table in the Optimized Colors folder inside the Photoshop application folder.

- 3 Click Save.

Important: When you reload the table, all shifted colors will appear as full swatches and will be unlocked.

Load a color table

- 1 Select Load Color Table from the Color Table palette menu.
- 2 Navigate to a file containing the color table you want to load—either an Adobe Color Table (.act) file, an Adobe Color Swatch (.aco) file, or a GIF file (to load the file's embedded color table).
- 3 Click Open.

PNG-24 optimization options

PNG-24 is suitable for compressing continuous-tone images; however, it produces much larger files than JPEG format. The advantage of using PNG-24 is that it can preserve up to 256 levels of transparency in an image.

Transparency and Matte Determine how transparent pixels in the image are optimized. See [“Optimize transparency in GIF and PNG images”](#) on page 517.

Interlace Displays a low-resolution version of the image in a browser while the full image file is downloading. Interlacing can make downloading time seem shorter and can assure viewers that downloading is in progress. However, interlacing also increases file size.

See also

[“Optimize an image for the web”](#) on page 508

WBMP optimization options

WBMP format is the standard format for optimizing images for mobile devices, such as cell phones. WBMP supports 1-bit color, which means that WBMP images contain only black and white pixels.

The Dithering Method and Dither options determine the method and amount of application dithering. For optimal compression, use the lowest percentage of dither that provides the detail you require.

You can select one of the following dithering methods:

No Dither Applies no dithering at all, rendering the image in purely black and purely white pixels.

Diffusion Applies a random pattern that is usually less noticeable than Pattern dither. The dither effects are diffused across adjacent pixels. If you select this algorithm, specify a Dither percentage to control the amount of dithering applied to the image.

Note: Diffusion dither may cause detectable seams to appear across slice boundaries. Linking slices diffuses the dither pattern across all linked slices, and eliminates the seams.

Pattern Applies a halftone-like square pattern to determine the value of pixels.

Noise Applies a random pattern similar to the Diffusion dithering, but without diffusing the pattern across adjacent pixels. No seams appear with the Noise algorithm.

See also

[“Optimize an image for the web”](#) on page 508

SWF optimization options (Illustrator)

The Adobe Flash (SWF) file format is a vector-based graphics file format for the creation of scalable, compact graphics for the web. Because the file format is vector-based, the artwork maintains its image quality at any resolution. The SWF format is ideal for the creation of animation frames, but you can also save raster images in SWF format or mix raster and vector graphics.

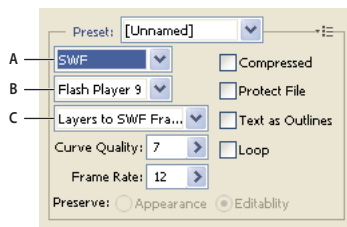

Optimization settings for SWF
A. File format menu B. Flash Player menu C. Export menu

Preset Specifies the preconfigured set of options you want to use for export. You can create new presets by setting options as desired, and then choosing Save Settings from the panel menu. (To open the panel menu, click the triangle to the right of the Preset menu.)

Flash Player Version Specifies the earliest version of Flash Player that will support the exported file.

Type Of Export Determines how layers are exported. Select AI File To SWF File to export the artwork to a single frame. Select Layers To SWF Frames to export the artwork on each layer to a separate SWF frame, creating an animated SWF.

Note: Select AI File To SWF File to preserve layer clipping masks.

Curve Quality Specifies the accuracy of the bezier curves. A low number decreases the exported file size with a slight loss of curve quality. A higher number increases the accuracy of the bezier curve reproduction, but results in a larger file size.

Frame Rate Specifies the rate at which the animation will play in a Flash viewer. This option is available only for Layers To SWF Frames.

Loop Causes the animation to loop continuously, rather than play once and then stop, when played in a Flash viewer. This option is available only for Layers To SWF Frames.

Preserve Appearance Expands strokes into stroke-shaped fills and flattens any blending modes and transparency that SWF doesn't support.

Preserve Editability Converts strokes to SWF strokes, and approximates or ignores transparency that SWF doesn't support.

Note: SWF supports object-level opacity only.

 Use the Export command instead of the Save For Web & Devices command to maintain artwork's stacking order by exporting each layer to a separate SWF file. You can then import the exported SWF files into Adobe Flash simultaneously.

Compressed Compresses the exported file.

Protect File Protects the file so that it cannot be imported by applications other than Flash.

Text As Outlines Converts all text to outlines to maintain appearance. If you plan to edit the text in Flash, don't select this option.

SVG optimization options (Illustrator)

SVG is a vector format that describes images as shapes, paths, text, and filter effects. The resulting files are compact and provide high-quality graphics on the web, in print, and even on resource-constrained handheld devices.

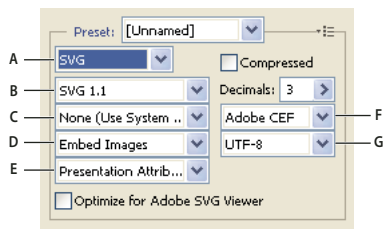

Optimization settings for SVG

A. File format menu B. SVG Profiles menu C. Font Subsetting menu D. Image Location menu E. CSS Properties menu F. Font Type menu G. Encoding menu

Compressed Creates a Compressed SVG (SVGZ) file.

SVG Profiles Specifies the SVG XML Document Type Definition for the exported file.

- **SVG 1.0 and SVG 1.1** Suitable for SVG files to be viewed on a desktop computer. SVG 1.1 is the full version of the SVG specification, of which SVG Tiny 1.1, SVG Tiny 1.1 Plus, SVG Tiny 1.2, and SVG Basic 1.1 are subsets.
- **SVG Basic 1.1** Suitable for SVG files to be viewed on medium powered devices, such as handhelds. Keep in mind that not all handhelds support the SVG Basic profile. As a result, selecting this option doesn't guarantee that the SVG file will be viewable on all handhelds. SVG Basic doesn't support nonrectangular clipping and some SVG filter effects.
- **SVG Tiny 1.1 and SVG Tiny 1.1+** Suitable for SVG files to be viewed on small devices, such as mobile phones. Keep in mind that not all mobile phones support the SVG Tiny and SVG Tiny Plus profiles. As a result, selecting either of these options doesn't guarantee that the SVG file will be viewable on all small devices.
- **SVG Tiny 1.2** Suitable for SVG files to be viewed on a variety of devices ranging from PDAs and cellphones to laptops and desktop computers.

SVG Tiny doesn't support gradients, transparency, clipping, masks, symbols, or SVG filter effects. SVG Tiny Plus includes the ability to display gradients and transparency, but it doesn't support clipping, masks, symbols, or SVG filter effects.

 For additional information on SVG profiles, see the SVG specification on the World Wide Web Consortium (W3C) website (www.w3.org).

Decimals Determines the precision of vector data in the SVG file. You can set a value of 1 to 7 decimal places. A high value results in a larger file size and increased image quality.

Font Subsetting Controls which glyphs are embedded from the SVG file. Select None from the Subsetting menu if you can rely on the necessary fonts being installed on end-user systems. Select Only Glyphs Used to only include glyphs for text that exists in the current artwork. The other values (Common English, Common English + Glyphs Used, Common Roman, Common Roman + Glyphs Used, All Glyphs) are useful when the textual content of the SVG file is dynamic (such as server-generated text or user-interactive text).

Font Type Specifies how fonts are exported.

- **Adobe CEF** Uses font hinting for better rendering of small fonts. This font type is supported by the Adobe SVG Viewer but may not be supported by other SVG viewers.
- **SVG** Doesn't use font hinting. This font type is supported by all SVG viewers.
- **Convert To Outlines** Converts type to vector paths. Use this option to preserve the visual appearance of type in all SVG Viewers.

Image Location Specifies whether to embed or link to images. Embedding images increases file size but ensures that rasterized images are always available.

CSS Properties Determines how CSS style attributes are saved in the SVG code. The default method, Presentation Attributes, applies properties at the highest point in the hierarchy, allowing the most flexibility for specific edits and transformations. The Style Attributes method creates the most readable files but may increase file size. Choose this method if the SVG code will be used in transformations—for example, transformations using XSLT (Extensible Stylesheet Language Transformation). The Entity References method results in faster rendering times and reduced SVG file size. The Style Element method is used when sharing files with HTML documents. By selecting Style Element, you can then modify the SVG file to move a style element into an external stylesheet file that is also referenced by the HTML file—however, the Style Element option also results in slower rendering speeds.

Encoding Determines how characters are encoded in the SVG file. UTF (Unicode Transformation Format) encoding is supported by all XML processors. (UTF-8 is an 8-bit format; UTF-16 is a 16-bit format.) ISO 8859-1 and UTF-16 encoding don't preserve file metadata.

Optimize For Adobe SVG Viewer Optimizes images for Adobe SVG Viewer.

Output settings for web graphics

Set output options

Output settings control how HTML files are formatted, how files and slices are named, and how background images are handled when you save an optimized image. You set these options in the Output Settings dialog box.

You can save your output settings and apply them to other files.

- 1 To display the Output Settings dialog box, do one of the following:
 - When you save an optimized image, choose Other from the Settings pop-up menu in the Save Optimized or Save Optimized As dialog box.
 - Choose Edit Output Settings from the Optimize pop-up menu in the Save For Web & Devices dialog box.
- 2 (Optional) To display predefined output options, choose an option from the Settings pop-up menu.
- 3 Edit each set of options as needed. To switch to a different set of options, choose an options set from the pop-up menu below the Settings menu. Alternatively, click Next to display the next set in the menu list; click Prev to display the previous set.
- 4 (Optional) To save output settings, set the options as desired, and click Save. Type a file name, choose a location for the saved file, and click Save.

You can save the output settings anywhere. However, if you place the file in the Optimized Output Settings folder inside the Photoshop folder or in the Save For Web Settings/Output Settings folder inside the Illustrator folder, the file will appear in the Settings pop-up menu.

- 5 (Optional) To load output settings, click Load, select a file, and click Open.

HTML output options

You can set the following options in the HTML set:

Output XHTML Creates web pages meeting the XHTML standard on export. Choosing Output XHTML disables other output options that might conflict with this standard. Selecting this option automatically sets the Tags Case and Attribute Case options.

Tags Case Specifies the capitalization for tags.

Attribute Case Specifies the capitalization for attributes.

Indent Specifies a method for indenting lines of code: using the authoring application's tab settings, using a specified number of spaces, or using no indentation.

Line Endings Specifies a platform for line ending compatibility.

Encoding Specifies a default character encoding for the web page.

Include Comments Adds explanatory comments to the HTML code.

Always Add Alt Attribute Adds the ALT attribute to IMG elements to comply with government web accessibility standards.

Always Quote Attributes Places quotation marks around all tag attributes. Placing quotation marks around attributes is required for compatibility with certain early browsers and for strict HTML compliance. However, always quoting attributes is not recommended. Quotation marks are used when necessary to comply with most browsers if this option is deselected.

Close All Tags Adds close tags for all HTML elements in the file for XHTML compliance.

Include Zero Margins On Body Tag Removes default internal margins in a browser window. Adds marginwidth, marginheight, leftmargin, and topmargin tags with values of zero to the body tag.

Slice output options

You can set the following options in the Slices set:

Generate Table Aligns slices using an HTML table rather than a cascading stylesheet.

Empty Cells Specifies how empty slices are converted to table cells. Select GIF, IMG W&H to use a 1-pixel GIF with width and height values specified on the IMG tag. Select GIF, TD W&H to use a 1-pixel GIF with width and height values specified on the TD tag. Select NoWrap, TD W&H to place a nonstandard NoWrap attribute on the table data and also place width and height values specified on the TD tags.

TD W&H Specifies when to include width and height attributes for table data: Always, Never, or Auto (the recommended setting).

Spacer Cells Specifies when to add one row and one column of empty spacer cells around the generated table: Auto (the recommended setting), Auto (Bottom), Always, Always (Bottom), or Never. For table layouts in which slice boundaries do not align, adding spacer cells can prevent the table from breaking apart in some browsers.

Generate CSS Generates a cascading stylesheet rather than an HTML table.

Referenced Specifies how slice positions are referenced in the HTML file when using CSS:

- **By ID** Positions each slice using styles that are referenced by a unique ID.
- **Inline** Includes style elements in the declaration of the block element <DIV> tag.
- **By Class** Positions each slice using classes that are referenced by a unique ID.

Default Slice Naming Choose elements from the pop-up menus or enter text into the fields to create default names for slices. Elements include the document name, the word *slice*, numbers or letters designating slices or rollover states, the slice creation date, punctuation, or none.

Background output settings

You can set the following options in the Background set of the Output Settings dialog box:

View Document As Select Image if you want the web page to display an image or a solid color as a background behind the current image. Select Background if you want the web page to display the optimized image as a tiled background.

Background Image Enter the location of an image file, or click Choose and select an image. The file you specify will be tiled behind the optimized image on the web page.

Color Click the Color box, and select a background color using the color picker, or select an option from the pop-up menu.

Saving Files output settings

You set the following options in the Saving Files set of the Output Settings dialog box:

File Naming Choose elements from the pop-up menus or enter text into the boxes to be combined into the default names for all files. Elements include document name, slice name, rollover state, trigger slice, file creation date, slice number, punctuation, and file extension. Some options are relevant only if the file contains slices or rollover states.

The text boxes let you change the order and formatting of the filename parts (for example, letting you indicate rollover state by an abbreviation instead of the full word).

Filename Compatibility Select one or multiple options to make the filename compatible with Windows (permits longer filenames), Mac OS, and UNIX.

Put Images In Folder Specifies a folder name where optimized images are saved (available only with documents containing multiple slices).

Copy Background Image When Saving Preserves a background image that has been specified in the Background preferences set.

Include title and copyright information with an image

You can add title and copyright information to a web page by entering information in the File Info dialog box. Title information appears in the web browser's title bar when the image is exported with an HTML file. Copyright information is not displayed in a browser; however, it is added to the HTML file as a comment and to the image file as metadata.

- 1 Choose File > File Info.
- 2 To enter a title that will appear in the web browser's title bar, in the Description section of the File Info dialog box, enter the desired text in the Document Title text box.
- 3 To enter copyright information, in the Description section of the File Info dialog box, enter the desired text in the Copyright Notice text box.
- 4 Click OK.

Chapter 18: Video and animation

In Adobe Photoshop CS4, you can create frame-based animations by modifying image layers to create movement and change. You can also create images for use in video, using one of many preset pixel aspect ratios. When you're done editing, you can save your work as an animated GIF file or as a PSD file that can be edited in many video programs, such as Adobe Premiere Pro or Adobe After Effects.

In Adobe Photoshop CS4 Extended, you can also import video files and image sequences for editing and retouching, create timeline-based animations, and export your work as QuickTime, animated GIF, or image sequences.

Video and animation in Photoshop

About video and video layers in Photoshop Extended

Important: To work with video in Photoshop Extended, you must install QuickTime 7.1 (or higher) on your computer. QuickTime is a free download from the Apple Computer website.

You can use Photoshop Extended to edit individual frames of video and image sequence files. In addition to using any Photoshop tool to edit and paint on video, you can also apply filters, masks, transformations, layers styles, and blending modes. After making edits, you can save the document as a PSD file (that can be played back in other Adobe applications such as Premiere Pro and After Effects or accessed as a static file in other applications), or you can render it as a QuickTime movie or image sequence.

Note: You can work only with the visual images in a video file, not the audio.

When you open a video file or image sequence in Photoshop Extended, the frames are contained within a *video layer*. In the Layers panel, a video layer is identified with a filmstrip icon . Video layers let you paint and clone on individual frames using the brush tools and stamp tools. Like working with regular layers, you can create selections or apply masks to restrict your edits to specific areas of a frame. You navigate through the frames using the timeline mode in the Animation panel (Window > Animation).

Note: Video layers do not work in frame mode (Animation panel).

You work with video layers just like regular layers by adjusting the blending mode, opacity, position, and layer style. You can also group video layers in the Layers panel. Adjustment layers let you apply color and tonal adjustments non-destructively to the video layers.

If you prefer to make your frame edits on a separate layer, you can create a blank video layer. Blank video layers also let you create hand-drawn animations.

Note: A video layer references the original file, so that edits to the video layer don't alter the original video or image sequence file. To maintain the link to the original file, ensure that it remains in the same location relative to the PSD file. For more information, see “Replace footage in a video layer (Photoshop Extended)” on page 539.

For a video on working with video layers, see www.adobe.com/go/vid0027.

See also

[“Creating images for video”](#) on page 532

[“Load video actions”](#) on page 535

[“Adjustment and fill layers”](#) on page 307

Supported video and image sequence formats (Photoshop Extended)

In Photoshop Extended, you can open video files and image sequences in the following formats.

QuickTime video formats

- MPEG-1 (.mpg or .mpeg)
- MPEG-4 (.mp4 or .m4v)
- MOV
- AVI
- FLV is supported if Adobe Flash Professional is installed.
- MPEG-2 is supported if an MPEG-2 encoder is installed on your computer.

Image sequence formats

- BMP
- DICOM
- JPEG
- OpenEXR
- PNG
- PSD
- Targa
- TIFF
- Cineon and JPEG 2000 are supported if the plug-ins are installed.

For more information on plug-ins and how to install them, see also [“Plug-ins”](#) on page 44.

Note: In Photoshop Extended, you can select multiple single-layer DICOM files and open them in a video layer (like opening an image sequence). See [“DICOM files \(Photoshop Extended\)”](#) on page 597.

Color mode and bit depth

Video layers can contain files in the following color modes and bits per channel (bpc):

- Grayscale: 8, 16, or 32 bpc
- RGB: 8, 16, or 32 bpc
- CMYK: 8 or 16 bpc
- Lab: 8 or 16 bpc

For a video on working with video layers, see www.adobe.com/go/vid0027.

Animation panel overview

An *animation* is a sequence of images, or *frames*, that is displayed over time. Each frame varies slightly from the preceding frame, creating the illusion of movement or other changes when the frames are viewed in quick succession.

In Photoshop, the Animation panel (Window > Animation) appears in frame mode, showing a thumbnail of each frame in your animation. Use the tools at the bottom of the panel to navigate through the frames, set looping options, add and delete frames, and preview the animation.

The Animation panel menu contains additional commands for editing frames or timeline durations, and for configuring the panel display. Click the panel menu icon to view available commands.

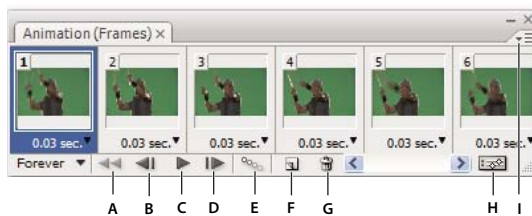

Animation panel (frame mode)

A. Selects the first frame B. Selects the previous frame C. Plays animation D. Selects the next frame E. Tweens animation frames F. Duplicates selected frames G. Deletes selected frames H. Converts to timeline mode (Photoshop Extended only) I. Animation panel menu

In Photoshop Extended, you can use the Animation panel in either frame mode or timeline mode. Timeline mode shows the frame duration and animation properties for document layers. Use the tools at the bottom of the panel to navigate through frames, zoom the time display in or out, toggle onion skin mode, delete keyframes, and preview the video. You can use controls on the timeline itself to adjust frame duration for a layer, set keyframes for layer properties, and designate a section of the video as the working area.

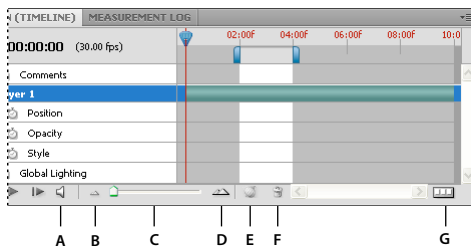

Animation panel (timeline mode)

A. Enable audio playback B. Zoom out C. Zoom slider D. Zoom in E. Toggle onion skins F. Delete keyframes G. Convert to frame animation

In timeline mode, the Animation panel displays each layer in a Photoshop Extended document (except the background layer) and is synchronized with the Layers panel. Whenever a layer is added, deleted, renamed, grouped, duplicated, or assigned a color, the changes are updated in both panels.

Note: When animated layers are grouped as a Smart Object, the animation information from the Animation panel is stored in the Smart Object. See also “About Smart Objects” on page 310.

For a video on the timeline mode, see www.adobe.com/go/vid0023.

Frame mode controls

In frame mode, the Animation panel includes the following controls:

Looping Options Sets the number of times an animation plays when exported as an animated GIF file.

Frame Delay Time Sets the duration of a frame during playback.

Tween Animation Frames  Adds a series of frames between two existing frames, *interpolating* (varying) the layer properties evenly between the new frames.



Duplicate Selected Frames  Adds a frame to the animation by duplicating the selected frame in the Animation panel.

Convert To Timeline Animation (Photoshop Extended)  Converts a frame animation to timeline animation using keyframes to animate layer properties.

Timeline mode controls (Photoshop Extended)

In timeline mode, the Animation panel includes the following features and controls:

Cached frames indicator Displays a green bar to indicate the frames that are cached for playback.

Comments track Choose Edit Timeline Comment from the panel menu to insert a text comment at the current time. Comments appear as icons  in the comments track. Move the pointer over these icons to display comments as tool tips. Double-click these icons to revise comments. To navigate from one comment to the next, click the Go To Previous  or Go To Next  buttons at the far left of the Comments track.

 To create an HTML table listing the time, frame number, and text of each comment, choose Export Timeline Comments from the panel menu.

Convert To Frame Animation Converts a timeline animation using keyframes to frame animation.

Timecode Or frame number display Shows the timecode or frame number (depending on panel options) for the current frame.

Current-time indicator  Drag the current-time indicator to navigate frames or change the current time or frame.

Global Lighting track Displays keyframes where you set and change the master lighting angle for layer effects such as Drop Shadow, Inner Shadow, and Bevel and Emboss.

Keyframe navigator  Arrow buttons to the left of a track label move the current-time indicator to the previous or next keyframe from its current position. Click the center button to add or delete a keyframe at the current time.

Layer duration bar Specifies a layer's place in time within a video or animation. To move the layer to another place in time, drag the bar. To trim (adjust the duration of) a layer, drag either end of the bar.

Altered Video track For video layers, displays a duration bar for altered frames. To jump to altered frames, use the keyframe navigator to the left of the track label.

Time ruler Measures duration (or frame count) horizontally, according to the document's duration and frame rate. (Choose Document Settings from the panel menu to change duration or frame rate.) Tick marks and numbers appear along the ruler and change in spacing with the zoom setting of the timeline.

Time-Vary stopwatch  Enables or disables keyframing for a layer property. Select this option to insert a keyframe and enable keyframing for a layer property. Deselect to remove all keyframes and disable keyframing for a layer property.

Animation panel menu Includes functions affecting keyframes, layers, panel appearance, onion skinning, and document settings.

Work area indicators Drag the blue tab at either end of the topmost track to mark the specific portion of the animation or video that you want to preview or export.

Change thumbnail size

In the Animation panel, you can change the size of the thumbnails that represent each frame or layer.

- 1 Choose Panel Options from the Animation panel menu.

2 Do one of the following:

- Select a size option.
- (Photoshop Extended) In timeline mode, select None to display only layer names.

Switch timeline units (Photoshop Extended)

In Photoshop Extended, you can display the Animation panel timeline in either frame number or timecode units.

- To select units to display, choose Panel Options from the Animation panel menu and select Frame Numbers or Timecode.
- To toggle between units, Alt-click (Windows) or Option-click (Mac OS) the current-time display in the upper-left corner of the timeline.

Show or hide layer properties in the timeline (Photoshop Extended)

In Photoshop Extended, as you add layers to a document, they appear as tracks in the timeline. Expand layer tracks to show layer properties that can be animated.

- ❖ To show or hide layer properties, click the triangle to the left of the layer name.

For a video on the timeline mode, see www.adobe.com/go/vid0023.

Show or hide layers in the timeline (Photoshop Extended)

In Photoshop Extended, all document layers appear in the timeline by default. To show only a subset of layers, first set them as favorites.

- 1 In timeline mode, select one or more layers from the Animation panel, then choose Show > Set Favorite Layers in the Animation panel menu.
- 2 To specify which layers are displayed, choose Show from the Animation panel menu, then select All Layers or Favorite Layers.

Navigate in the timeline (Photoshop Extended)



- ❖ With the Animation panel in timeline mode, do any of the following:
 - Drag the current-time indicator .
 - Click a number or location in the time ruler where you want to position the current-time indicator.
 - Drag the current-time display (in the upper-left corner of the timeline).
 - Double-click the current-time display and enter a frame number or time in the Set Current Time dialog box.
 - Use the playback controls in the Animation panel.
 - Choose Go To in the Animation panel menu, and then choose a timeline option.

Switch animation modes (Photoshop Extended)

In Photoshop Extended, you can use the Animation panel in either frame or timeline animation mode. Frame mode shows each separate frame, letting you set unique duration and layer properties for each. Timeline mode shows frames in a continuous timeline, letting you animate properties with keyframes and play video layers.

Ideally, you should select the mode you want before starting an animation. However, it's possible to switch animation modes in an open document, converting a frame animation to a timeline animation, or vice versa.

Important: You may lose some interpolated keyframes when converting a timeline animation to a frame animation. The animation appearance doesn't change, however.

- ❖ In the Animation panel, do any of the following:
 - Click the Convert To Frame Animation icon .
 - Click the Convert To Timeline Animation icon .
 - From the Animation panel menu, choose either Convert To Frame Animation or Convert To Timeline.

Specify timeline duration and frame rate (Photoshop Extended)

When you are working in timeline mode, you can specify the duration and frame rate of a document containing video or animation. *Duration* is the overall time length of the video clip, from the first frame you specify to the last. *Frame rate* or frames per second (fps), is usually determined by the type of output you produce: NTSC video has a frame rate of 29.97 fps; PAL video has a frame rate of 25 fps; and motion picture film has a frame rate of 24 fps. Depending on the broadcast system, DVD video can have the same frame rate as NTSC video or PAL video, or a frame rate of 23.976. Video intended for CD-ROM or the web typically has a frame rate of 10 to 15 fps.

When you create a new document, the default timeline duration is 10 seconds. The frame rate depends on the chosen document preset. For non-video presets (like International Paper), the default rate is 30 fps. For video presets, the rate is 25 fps for PAL and 29.97 for NTSC.

- 1 From the Animation panel menu, choose Document Settings.
- 2 Enter or choose values for Duration and Frame Rate.

Note: Reducing the duration of an existing video or animation has the effect of trimming frames (and any keyframes) from the end of the document.

See also

[“Set the timeline area to preview \(Photoshop Extended\)”](#) on page 560

[Understanding the timeline mode video](#)

Creating images for video

About creating images for video

Photoshop can create images of various aspect ratios so that they appear properly on devices such as video monitors. You can select a specific video option (using the New dialog box) to compensate for scaling when the final image is incorporated into video.

Safe zones

The Film & Video preset also creates a document with nonprinting guides that delineate the action-safe and title-safe areas of the image. Using the options in the Size menu, you can produce images for specific video systems—NTSC, PAL, or HDTV.

Safe zones are useful when you edit for broadcast and videotape. Most consumer TV sets use a process called overscan, which cuts off a portion of the outer edges of the picture, allowing the center of the picture to be enlarged. The amount of overscan is not consistent across TVs. To ensure that everything fits within the area that most TVs display, keep text within the title-safe margins, and all other important elements within the action-safe margins.

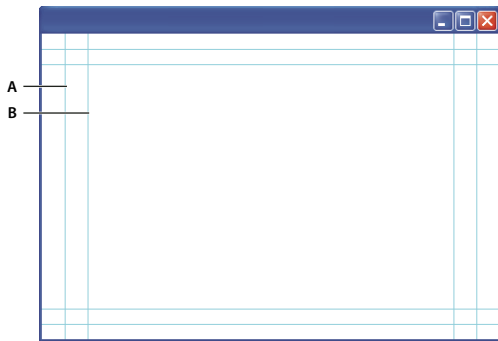

Video preset file size guides
A. Action safe area (outer rectangle) **B.** Title safe area (inner rectangle)

Note: If you are creating content for the web or for CD, the title-safe and action-safe margins do not apply to your project because the entire image is displayed in these media.

Preview options

To help you create images for video, Photoshop has a Pixel Aspect Ratio Correction viewing mode that displays images at the specified aspect ratio. For more accurate previews, Photoshop also has a Video Preview command that lets you immediately preview your work on a display device, such as a video monitor. To use this feature, you must have the device connected to your computer via FireWire (IEEE 1394). See also “[Preview your document on a video monitor](#)” on page 561. For more information on FireWire (IEEE 1394), see Apple’s website.

Other considerations

Both Adobe After Effects and Adobe Premiere Pro support PSD files created in Photoshop. However, if you’re using other film and video applications, you might consider these details when you create images for use in video:

- Some video-editing programs can import individual layers from a multilayer PSD file.
- If the file has transparency, some video-editing programs preserve it.
- If the file uses a layer mask or multiple layers, you might not have to flatten the layers, but you might want to include a flattened copy of the file in PSD format to maximize backward compatibility.

Aspect ratio

Frame aspect ratio describes the ratio of width to height in the dimensions of an image. For example, DV NTSC has a frame aspect ratio of 4:3 (or 4 width by 3 height) and a typical widescreen frame has a frame aspect ratio of 16:9. Some video cameras can record various frame aspect ratios. Many cameras that have a widescreen mode use the 16:9 aspect ratio. Many professional films have been shot using even wider aspect ratios.

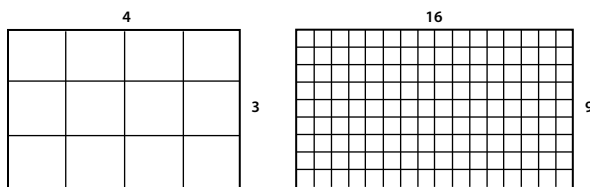

4:3 frame aspect ratio (left), and wider 16:9 frame aspect ratio (right)

Pixel aspect ratio describes the ratio of width to height of a single pixel in a frame. Different video standards use different pixel aspect ratios. For example, many computer video standards define a 4:3 aspect ratio frame as 640 pixels wide by 480 pixels high, which results in square pixels. The computer video pixels in this example have a pixel aspect ratio of 1:1 (square), whereas the DV NTSC pixels have a pixel aspect ratio of 0.91 (nonsquare). DV pixels, which are always rectangular, are vertically oriented in systems producing NTSC video and horizontally oriented in systems producing PAL video.

If you display rectangular pixels on a square-pixel monitor without alteration, images appear distorted; for example, circles distort into ovals. However, when displayed on a broadcast monitor, the images appear correctly proportioned because broadcast monitors use rectangular pixels.

Note: When copying or importing images into a nonsquare pixel document, Photoshop automatically converts and scales the image to the pixel aspect ratio of the document. Images imported from Adobe Illustrator CS4 are also properly scaled.

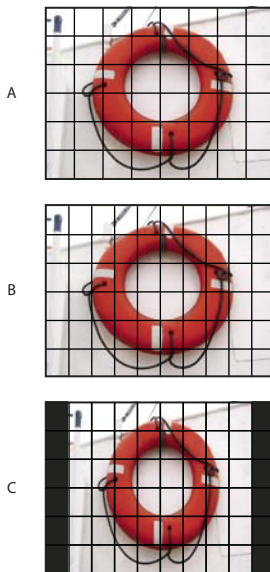

Pixel and frame aspect ratios

A. 4:3 square-pixel image displayed on 4:3 square-pixel (computer) monitor **B.** 4:3 square-pixel image interpreted correctly for display on 4:3 non-square pixel (TV) monitor **C.** 4:3 square-pixel image interpreted incorrectly for display on 4:3 non-square pixel (TV) monitor

Create an image for use in video

- 1 Create a new document.
- 2 From the Preset menu in the New dialog box, choose the Film & Video preset.
- 3 Choose the size that's appropriate for the video system on which the image will be shown.
- 4 Click Advanced to specify a color profile and specific pixel aspect ratio.

Important: By default, nonsquare pixel documents open with *Pixel Aspect Ratio Correction* enabled. This setting scales the image so it appears as it would on the nonsquare-pixel output device (usually a video monitor).

- 5 To view the image as it would appear on a computer monitor (square pixel), choose View > Pixel Aspect Ratio Correction.

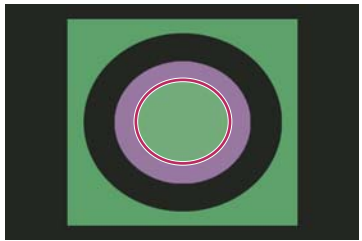
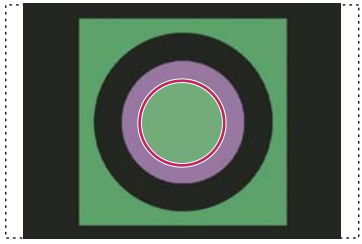

Circle in NTSC DV (720 x 480 pixels) document viewed on computer (square pixel) monitor with Pixel Aspect Ratio Correction turned on (top) and Pixel Aspect Ratio Correction turned off (bottom)

 You can simultaneously view an image with the Pixel Aspect Ratio Correction turned on and off. With the nonsquare pixel image open and Pixel Aspect Ratio Correction enabled, choose **Window > Arrange > New Window For [name of document]**. With the new window active, choose **View > Pixel Aspect Ratio Correction** to turn off the correction.

- 6** If you have a display device, such as a video monitor, connected to your computer via FireWire, you can preview the document on the device:
- To set output options before previewing the image, choose **File > Export > Video Preview**.
 - To view the image without setting output options, choose **File > Export > Send Video Preview To Device**.

 When creating images for video, you can load a set of video actions (included with Photoshop) that automate certain tasks—such as scaling images to fit video pixel dimensions and setting the pixel aspect ratio.

See also

[“Preview your document on a video monitor”](#) on page 561

Load video actions

For video images, actions automate tasks such as constraining the luminance range and saturation levels to comply with broadcast standards, resizing and converting to nonsquare pixels for use in DVD slide shows (NTSC and PAL, standard and widescreen aspect ratios), creating an alpha channel from all currently visible layers, adjusting image areas (especially thin lines) that are likely to cause interlace flicker, and generating a title-safe overlay.

- 1 Choose **Window > Actions** to display the Actions panel.
- 2 Click the triangle in the upper right corner of the panel, and choose **Video Actions** from the menu.

See also

[“Automating tasks”](#) on page 614

Adjust pixel aspect ratio

You can create a custom pixel aspect ratio in existing documents, or delete or reset pixel aspect ratios previously assigned to a document.

Assign a pixel aspect ratio value to an existing document

- ❖ With a document open, choose View > Pixel Aspect Ratio and then choose a pixel aspect ratio that's compatible with the video format that you'll be using your Photoshop file with.

Create a custom pixel aspect ratio

- 1 With a document open, choose View > Pixel Aspect Ratio > Custom Pixel Aspect Ratio.
- 2 In the Save Pixel Aspect Ratio dialog box, enter a value in the Factor text box, name the custom pixel aspect ratio, and click OK.

The new custom pixel aspect ratio appears in both the Pixel Aspect Ratio menu of the New dialog box and in the View > Pixel Aspect Ratio menu.

Delete a pixel aspect ratio

- 1 With the document open, choose View > Pixel Aspect Ratio > Delete Pixel Aspect Ratio.
- 2 In the Delete Pixel Aspect Ratio dialog box, choose the item to delete from the Pixel Aspect Ratio menu, and click Delete.

Reset the pixel aspect ratios

- 1 With the document open, choose View > Pixel Aspect Ratio > Reset Pixel Aspect Ratios.
- 2 In the dialog box, choose one of the following:

Append Replaces the current pixel aspect ratios with the default values plus any custom pixel aspect ratios. This option is useful if you deleted a default value and want to restore it to the menu but also want to retain any custom values.

OK Replaces the current pixel aspect ratios with the default values. Custom pixel aspect ratios are discarded.

Cancel Cancels the command.

Prepare images for use in After Effects

You can import a Photoshop (PSD) file directly into an After Effects project with the option of preserving individual layers, layer styles, transparent areas and layer masks, and adjustment layers (preserving the individual elements for animation).

***Note:** After Effects works in RGB color mode. For best results, work in RGB mode in Photoshop for files you will be exporting to After Effects. After Effects CS4 can convert files from CMYK to RGB. After Effects 7 and earlier cannot convert files from CMYK to RGB.*

Before you export a layered Photoshop file for use in After Effects, do the following to reduce preview and rendering time and to avoid problems with importing and updating Photoshop layers.

- Organize and name layers. If you change a layer name or delete a layer in a Photoshop document after you import it into After Effects, After Effects won't be able to find the renamed or deleted layer. The After Effects Project panel lists that layer as missing. (You can also group layers into Smart Objects. For example: If you used a set of layers to make a foreground object and a set of layers to make a background, you can group them as one Smart Object each, and easily animate one to fly in front of the other).
- Make sure that each layer has a unique name. Duplicate layer names can cause confusion.
- Choose Always from the Maximize PSD And PSB File Compatibility menu in the File Handling Preferences dialog box.
- Use the appropriate pixel dimension preset for video and film in the New Document dialog box.

- Do any required color correction, scaling, cropping, or other edits in Photoshop so that After Effects doesn't have to do extra image-processing work. (You can also assign a color profile to the image that corresponds to the intended output type, such as Rec. 601 NTSC or Rec. 709. After Effects can read embedded color profiles and interpret the image's colors accordingly. For more information on color profiles, see “[Working with color profiles](#)” on page 139

Importing video files and image sequences (Photoshop Extended)

Open or import a video file (Photoshop Extended)

In Photoshop Extended, you can open a video file directly or add video to an open document. When you import video, the image frames are referenced in a video layer.

- 1 Do one of the following:
 - To open a video file directly, choose File > Open.
 - To import video into an open document, choose Layer > Video Layers > New Video Layer From File.
- 2 In the Open dialog box, for Files Of Type (Windows) or Enable (Mac OS), choose either All Readable Documents or QuickTime Movie.
- 3 Select a video file and then click Open.

 You can also open video directly from Bridge: select a video file and then choose File > Open With > Adobe Photoshop CS4.

For a video on working with video layers, see www.adobe.com/go/vid0027

See also

“[Supported video and image sequence formats \(Photoshop Extended\)](#)” on page 528

“[About missing and mismatched color profiles](#)” on page 146

Import image sequences (Photoshop Extended)

When you import a folder of sequenced image files, each image becomes a frame in a video layer.

- 1 Make sure that the image files are in one folder and are named sequentially.

The folder should contain only those images you want to use as frames. The resulting animation will be more successful if all files have the same pixel dimensions. To order frames correctly for the animation, name the files in alphabetical or numeric order. For example, *filename001*, *filename002*, *filename003*, and so forth.

- 2 Do one of the following:
 - To open an image sequence directly, choose File > Open.
 - To import an image sequence into an open document, choose Layer > Video Layers > New Video Layer From File.
- 3 In the Open dialog box, navigate to the folder with image sequence files.
- 4 Select one file, choose the Image Sequence option, and then click Open.

Note: Selecting more than one file in an image sequence disables the Image Sequence option.

5 Specify the frame rate, and click OK.

For a video on working with Image Sequences, see www.adobe.com/go/vid0026.

See also

“Supported video and image sequence formats (Photoshop Extended)” on page 528

[Working with Image Sequences](#)

Place a video or image sequence (Photoshop Extended)

Use the Place command if you want to transform the video or image sequence as you import it into a document. Once placed, the video frames are contained within a Smart Object. When video is contained by a Smart Object, you can navigate through the frames using the Animation panel, and you can also apply Smart Filters.

Note: You can't paint or clone directly on video frames contained by a Smart Object. However, you can add a blank video layer above the Smart Object, and paint on the blank frames. You can also use the Clone tool with the Sample All Layers option to paint on blank frames. This lets you use the video in the Smart Object as a cloning source.

- 1 With a document open choose File > Place.
- 2 In the Place dialog box, do one of the following:
 - Select a video file and click Place.
 - Select one image sequence file, select the Image Sequence option, and then click Place.

Note: Make sure all the image sequence files are in one folder.

- 3 (Optional) Use the control points to scale, rotate, move, or warp the imported content.
- 4 Click the Commit Transform button  in the options bar to place the file.

 You can also place video directly from Adobe Bridge CS4. Select the video file and then choose File > Place > In Photoshop.

See also

“About Smart Objects” on page 310

“Transform video layers (Photoshop Extended)” on page 543

“About Smart Filters” on page 313

“Create new video layers” on page 543

Reload footage in a video layer (Photoshop Extended)

If the source file for a video layer is modified in a different application, Photoshop Extended generally reloads and updates the footage, when you open the document containing the video layer referencing the changed source file. If your document is already open and the source file has been modified, use the Reload Frame command to reload and update the current frame in the Animation panel. Navigating through the video layer using the Previous/Next Frame or Play button in the Animation panel should also reload and update the footage.

Replace footage in a video layer (Photoshop Extended)

Photoshop Extended tries to maintain the link between the video layer and source file even if you move or rename the source. If the link breaks for some reason, an alert icon  appears on the layer in the Layers panel. To relink the video layer to the source file, use the Replace Footage command. This command can also replace the video or image sequence frames in a video layer with frames from a different video or image sequence source.

- 1 In the Animation or Layers panel, select the video layer that you want to relink to the source file or to replace the content.
- 2 Choose Layer > Video Layers > Replace Footage.
- 3 In the Open dialog box, select a video or image sequence file, and then click Open.

Interpreting video footage (Photoshop Extended)

Interpret video footage (Photoshop Extended)

You can specify how Photoshop Extended interprets the alpha channel and frame rate of the video you've opened or imported.

- 1 In the Animation or Layers panel, select the video layer that you want to interpret.
- 2 Choose Layer > Video Layers > Interpret Footage.
- 3 In the Interpret Footage dialog box, do any of the following:
 - To specify how the alpha channel in the video layer is interpreted, select an Alpha Channel option. The footage must have an alpha channel for this option to be available. If Premultiplied-Matte is selected, you can specify the matte color with which the channels are premultiplied.
 - To specify the number of video frames played per second, enter a Frame Rate.
 - To color-manage the frames or images in a video layer, choose a profile from the Color Profile menu.

Alpha channel interpretation in video and image sequences (Photoshop Extended)

Video and image sequences with alpha channels can be straight or premultiplied. If you're working with video or image sequences containing alpha channels, it's important to specify how Photoshop Extended interprets the alpha channel to get the results you expect. When premultiplied video or images are in a document with certain background colors, it's possible to get undesirable ghosting or halos. You can specify a matte color so the semi-transparent pixels blend (multiply) with the background without producing halos.

Ignore Ignores the alpha channel in the video.

Straight-Unmatted Interprets the alpha channel as straight alpha transparency. If the application you used to create the video doesn't premultiply the color channels, select this option.

Premultiplied-Matte Uses the alpha channel to determine how much of the matte color to mix with the color channels. If necessary, click the color swatch in the Interpret Footage dialog box to specify the matte color.



Item with premultiplied channels (top) appears with a black halo when interpreted as Straight-Unmatted (lower-left). When interpreted as Premultiplied-Matte with black specified as background color, halo does not appear (lower-right).

Painting frames in video layers (Photoshop Extended)

Paint frames in video layers (Photoshop Extended)

You can edit or paint on individual video frames to create an animation, add content, or to remove unwanted details. In addition to using any brush tool, you can paint using the Clone Stamp, Pattern Stamp, Healing Brush, or Spot Healing Brush. You can also edit video frames using the Patch tool.

Note: Painting (or using any other tool) on video frames is often called rotoscoping; although traditionally, rotoscoping involves the frame-by-frame tracing of live action images for use in animation.

- 1 In the Animation or Layers panel, select the video layer.
- 2 Move the current time indicator to the video frame you want to edit.
- 3 (Optional) If you want your edits to be on a separate layer, choose Layers > Video Layers > New Blank Video Layer.
- 4 Select the brush tool that you want to use and apply your edits to the frame.

Painting on a video layer is nondestructive. To discard the altered pixels on a specific frame or video layer, choose the Restore Frame or Restore All Frames command. To toggle on and off the visibility of altered video layers, choose the Hide Altered Video command (or click the eyeball next to the altered video track in the timeline).

For a video on cloning, see www.adobe.com/go/vid0025.

For a video on working with video layers, see www.adobe.com/go/vid0027.

See also

[Cloning video](#)

“Paint with the Brush tool or Pencil tool” on page 329

“Retouching and repairing images” on page 197

“Restore frames in video layers (Photoshop Extended)” on page 542

“Create hand-drawn animations (Photoshop Extended)” on page 558

Cloning content in video and animation frames (Photoshop Extended)

In Photoshop Extended, you can use the Clone Stamp and Healing Brush tools to retouch or duplicate objects in video or animation frames. Use the Clone Stamp to *sample* content from one part of a frame (the *source*) and paint it over another part of the same or different frame (the *target*). You can also use a separate document as the sampling source, instead of a frame. The Healing Brush includes options for blending the sampled content with the target frame.

Note: You can also clone content with the Spot Healing Brush and the Patch tools. However, the Clone Stamp and the Healing Brush tools let you store up to five samples in the Clone Source panel, and set overlay, scaling, and frame offset options.

After you sample content from a frame and paint with it, and then move to another frame, the source frame changes relative to the frame you initially sampled from. You can lock in the source frame you first sampled, or enter a frame offset value to change the source to a different frame, relative to the frame you first sampled.

For a video on cloning, see www.adobe.com/go/vid0025.

See also

[Cloning video](#)



“Retouch with the Clone Stamp tool” on page 197

“Retouch with the Healing Brush tool” on page 200



“Set sample sources for cloning and healing” on page 198

“Create new video layers” on page 543

Clone video or animation content

- 1 Select the Clone Stamp tool  or Healing Brush tool , and then set the tool options you want.
- 2 Do one of the following:
 - Select a video layer in the Layers panel or Animation panel, and then move the current-time indicator to the frame you want to sample.
 - Open the image you want to sample.
- 3 Position the pointer in an open image or frame, and Alt-click (Windows) or Option-click (Mac OS) to set the sampling point.
- 4 To set additional sampling points, click each clone source button  in the Clone Source panel.
- 5 Select the target video layer and move the current-time indicator to the frame you want to paint.

 If you want to paint on a separate layer, you can add a blank video layer. Make sure you choose the appropriate *Sample* option to clone content onto the blank video layer.

- 6 If you have set multiple sampling points, select the source you want to use in the Clone Source panel.
 - 7 Do any of the following in the Clone Source panel:
 - To scale or rotate the source that you’re cloning, enter a value for W (width) or H (height), or the rotation in degrees .
 - To show an overlay of the source that you’re cloning, select Show Overlay and specify the overlay options. (The Clipped option restricts the overlay to the brush size. Deselect this option to overlay the entire source image.)
-  To move the source overlay to an offset position, Shift + Alt-drag (Windows) or Shift + Option-drag (Mac OS). To temporarily show overlays, deselect Show Overlay, and press Shift + Alt (Windows) or Shift + Option (Mac OS).

8 Drag over the area of the frame you want to paint.

Painting on a video layer is nondestructive. You can choose the Restore Frame or Restore All Frames command to discard the altered pixels on a specific frame or video layer.

Change frame offset for cloning or healing

❖ In the Clone Source panel:

- To always paint using the same frame you initially sampled from, select Lock Frame.
- To paint using a frame relative to the frame you initially sampled from, enter the number of frames in the Frame Offset box. If the frame you want to use is after the frame you initially sampled, enter a positive value. If the frame you want to use is before the frame you initially sampled, enter a negative value.

Restore frames in video layers (Photoshop Extended)

You can discard edits made to frame video layers and blank video layers.

❖ In the Animation panel, select a video layer and do one of the following:

- To restore a specific frame, move the current-time indicator to the video frame and choose Layer > Video Layers > Restore Frame.
- To restore all the frames in a video layer or blank video layer, choose Layer > Video Layers > Restore All Frames.

Managing color in video layers (Photoshop Extended)

In Photoshop Extended, you can paint on video layers using tools such as the brush tool or the clone stamp tool. If no color profile is assigned to the video layer, these pixel edits are stored using the document file's color space, and the video footage itself is left unchanged. If the color space of the imported footage is different from the color space of your Photoshop document, you may need to make adjustments. For example, a standard definition video movie may be in SDTV 601 NTSC, while the Photoshop Extended document is in Adobe RGB. Your final exported video or document might not have the colors you expect due to the color space mismatch.

 *Before investing a lot of time painting or editing video layers, test your complete workflow to understand your color management needs and find the approach that works best for your workflow.*

Often, you can solve a mismatch by assigning a color profile to the document that corresponds to the imported footage, and leaving the video layer unmanaged. For example, with standard definition video, you can leave the video layer unmanaged and assign the document the SDTV (Rec. 601 NTSC) color profile. In this case, the imported frame pixels are stored directly in the video layer without color conversion.

Conversely, you can assign the document's color profile to the video layer using the Convert Edited Frame Content option (Layers > Video Layers > Interpret Footage). This option converts the pixel edits to the document's color space, but does not convert the colors of the video frames.

The Convert To Profile command (Edit > Convert To Profile) also converts all pixel edits to the document's color space. However, using the Assign Profile command (Edit > Assign Profile) does not convert the pixel edits to a video layer. Use the Assign Profile command with care, especially when you've painted on or edited video frames. If the video layer has a color profile, applying the Assign Profile command to the document may cause a color space mismatch between the pixel edits and the imported frames.

Some combinations of video footage and document color spaces require color conversion:

- A grayscale movie in an RGB, CMYK, or Lab mode document requires color conversion.
- Using 8- or 16-bpc footage in a 32-bpc document requires color conversion.

See also

[“Understanding color management”](#) on page 126

[“Assign or remove a color profile \(Illustrator, Photoshop\)”](#) on page 142

[“Convert document colors to another profile \(Photoshop\)”](#) on page 143

Editing video and animation layers (Photoshop Extended)

Transform video layers (Photoshop Extended)

You can transform a video layer as you transform any other layer in Photoshop. However, you must convert video layers to Smart Objects before you can transform them.

- 1 In the Animation or Layers panel, select the video layer.
- 2 Do any of the following:
 - Choose Edit > Free Transform to use handles in the document window to transform the video.
 - Choose Edit > Transform and choose a specific transformation from the submenu.

If the video layer is not a Smart Object, Photoshop asks you to convert it.

See also

[“Transforming objects”](#) on page 214

[“About Smart Objects”](#) on page 310

Create new video layers

You can create new video layers by adding a video file as a new layer or creating a blank layer.

For a video on working with video layers, see www.adobe.com/go/vid0027

See also

[“Importing video files and image sequences \(Photoshop Extended\)”](#) on page 537

[“Place a video or image sequence \(Photoshop Extended\)”](#) on page 538

[“Replace footage in a video layer \(Photoshop Extended\)”](#) on page 539

Open a video file

- ❖ Choose File > Open, select a video file, and click Open.

The video appears on a video layer in a new document.

Add a video file as a new video layer

- 1 For the active document, make sure the Animation panel is displayed in timeline mode.
- 2 Choose Layer > Video Layers > New Video Layer From File.
- 3 Select a video or image sequence file and click Open.

Add a blank video layer

- 1 For the active document, make sure the Animation panel is displayed in timeline mode.
- 2 Choose Layer > Video Layers > New Blank Video Layer.

Specify when a layer appears in a video or animation (Photoshop Extended)

You can use various methods to specify when a layer appears in a video or animation. For example, you can trim (hide) frames at the beginning or end of a layer. This changes the layer's start and end points in a video or animation. (The first frame to appear is called the In point, and the last frame is called the Out point.) You can also drag the entire layer duration bar to a different portion of the timeline.

- 1 In the Animation panel, select the layer.
- 2 Do any of the following:
 - To specify the In and Out points of a layer, drag the beginning and end of the layer duration bar.
 - Drag the layer duration bar to the section of the timeline where you want the layer to appear.

Note: For best results, drag the layer duration bar after the bar has been trimmed.

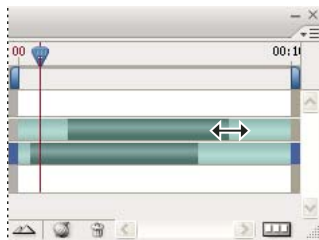

Layers (In timeline mode) with the layer duration bar selected to drag

- Move the current-time indicator to the frame you want as the new In or Out point, and from the Animation panel menu, choose Trim Layer Start To Current Time or Trim Layer End To Current Time.

This shortens the layer duration by hiding the frames between the current-time indicator and either the start or the end of the layer. (Re-extending the ends of the layer duration bar reveals the hidden frames.)

- Use keyframes to change the layer's opacity at specific times or frames.

Note: To delete footage in one or more layers, use the Lift Work Area command. To delete a specific duration from all video or animated layers, use the Extract Work Area command.

Trim or move a video layer (Photoshop Extended)

To hide frames at the start or end of a video or animation layer, trim the layer. To start or end video at a different time point, move the video layer.

 If you move video layers, changes become permanent when you save the file. If you trim video, however, you can restore it by re-extending the ends of the layer duration bar.

- 1 In the Animation or Layers panel, select the layer you want to edit.
- 2 Move the current-time indicator to the frame (or time) you want as the new In point or Out point.
- 3 On the Animation panel menu, choose one of the following options:

Move Layer In Point To Current Time Permanently moves the start of the layer to the current-time indicator.

Move Layer End Point To Current Time Permanently moves the end of the layer to the current-time indicator.

Trim Layer Start To Current Time Temporarily hides section from the current-time indicator to the start of the layer.

Trim Layer End To Current Time Temporarily hides section from the current-time indicator to the end of the layer.

Note: You can also use the Lift Work Area command to hide frames in one or more layers, or the Extract Work Area command to hide a specific duration in all layers of a video or animation.

Lift work area (Photoshop Extended)

A section of the footage in selected layers can be deleted, leaving a gap of the same duration as the removed section.

- 1 Select the layers you want to edit.
- 2 In the Animation panel, set the work area to specify the duration of the selected layers you want to omit.
- 3 From the Animation panel menu, choose Lift Work Area.

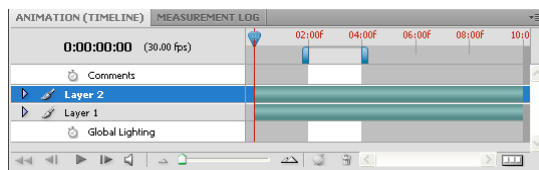

Layers before applying the Lift Work Area command

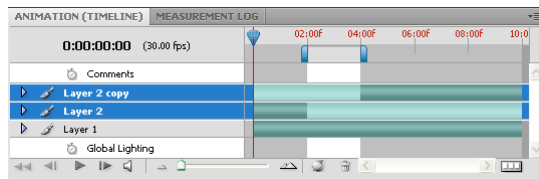

Layers after applying the Lift Work Area command

Extract work area (Photoshop Extended)

To delete portions of video and automatically remove the time gap, use the Extract Work Area command. The remaining content is copied to new video layers.

- 1 Select the layers you want to edit.
- 2 In the Animation panel, set the work area to specify the duration of the video or animation that you want to omit.
- 3 From the Animation panel menu, choose Extract Work Area.

Split video layers (Photoshop Extended)

A video layer can be split into two new video layers at the frame you specify.

- 1 Select a video layer in the Animation panel.
- 2 Move the current-time indicator to the time or frame number where you want to split the video layer.
- 3 Click the panel menu icon , and choose Split Layer.

The selected video layer is duplicated and appears immediately above the original in the Animation panel. The original layer is trimmed from the start to the current time, and the duplicate layer is trimmed from the end to the current time.

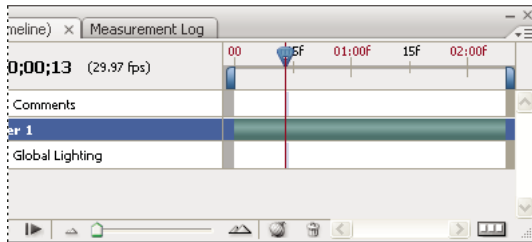

Original layer before using the Split Layer command

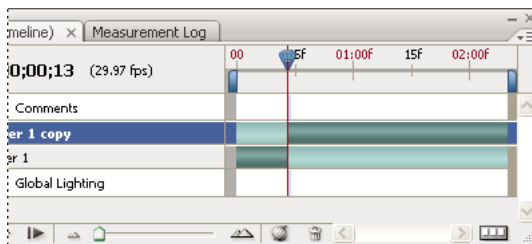

Resulting two layers after using the Split Layer command

Group layers in a video or animation (Photoshop Extended)

As you add more layers to your video or animation, you might want to organize them into a hierarchy. One of the easiest ways is to group the layers. Photoshop preserves the frames in your video or animation in grouped layers.

You can also group a *group of layers*. Besides nesting your layers in a more complex hierarchy, grouping a group of layers lets you simultaneously animate the opacity of all the grouped layers. The Animation panel displays a group of grouped layers with a common opacity layer property.

 *Grouping video layers in Photoshop is similar to precomposing in Adobe After Effects.*

- ❖ In the Layers panel, select two or more layers and do one of the following:
 - Choose Layer > Group Layers.
 - Choose Layer > Smart Objects > Convert to Smart Object.

For a video on working with video layers, see www.adobe.com/go/vid0027.

Rasterize video layers (Photoshop Extended)

When you rasterize video layers, the selected layer is flattened to a composite of the current frame selected in the Animation panel. Although it's possible to rasterize more than one video layer at a time, you'll only be able to specify the current frame for the topmost video layer.

- 1 In the Layers panel, select the video layer.
- 2 In the Animation panel, move the current-time indicator to the frame that you want preserved when you rasterize the video layer.
- 3 Do either of the following:
 - Choose Layer > Rasterize > Video.
 - Choose Layer > Rasterize > Layer.

Note: To rasterize more than one video layer at a time, select the layers in the Layers panel, set the current-time indicator to the frame you want to preserve in the topmost video layer, and then choose *Layer > Rasterize > Layers*.

Creating frame animations

Frame animation workflow

In Photoshop, you use the Animation panel to create animation frames. Each frame represents a configuration of layers.

Note: In Photoshop Extended, you can also create animations using a timeline and keyframes. See “[Creating timeline animations \(Photoshop Extended\)](#)” on page 554.

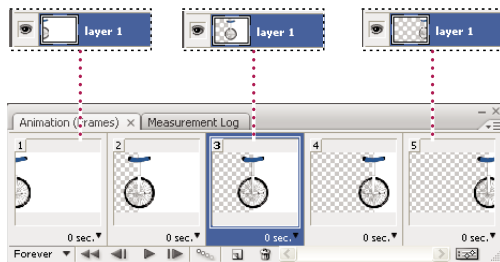

Illustration of an animation. The unicycle image is on its own layer; the position of the layer changes in each frame of the animation.

To create frame-based animations in Photoshop, use the following general workflow.

1. Open a new document.

If they are not already visible, open the Animation and Layers panels, as well. In Photoshop Extended, make sure the Animation panel is in frame animation mode (click the Convert to Frame Animation button in the Animation panel).

2. Add a layer or convert the background layer.

Because a background layer cannot be animated, add a new layer or convert the background layer to a regular layer. See “[Convert background and layers](#)” on page 281.

3. Add content to your animation.

If your animation includes several objects that are animated independently, or if you want to change the color of an object or completely change the content in a frame, create the objects on separate layers.

4. Add a frame to the Animation panel.

See “[Add frames to an animation](#)” on page 548.

5. Select a frame.

See “[Select animation frames](#)” on page 548.

6. Edit the layers for the selected frame.

Do any of the following:

- Turn visibility on and off for different layers.
- Change the position of objects or layers to make layer content move.

- Change layer opacity to make content fade in or out.
- Change the blending mode of layers.
- Add a style to layers.

Photoshop provides tools for keeping characteristics of a layer the same across frames. See “[Changing attributes of layers in animations](#)” on page 550.

7. Add more frames and edit layers as needed.

The number of frames you can create is limited only by the amount of system memory available to Photoshop.

You can generate new frames with intermediate changes between two existing frames in the panel using the Tween command. This is a quick way to make an object move across the screen or to fade in or out. See “[Create frames using tweening](#)” on page 551.

8. Set frame delay and looping options.

You can assign a delay time to each frame and specify looping so that the animation runs once, a certain number of times, or continuously. See “[Specify a delay time in frame animations](#)” on page 552 and “[Specify looping in frame animations](#)” on page 553.

9. Preview the animation.

Use the controls in the Animation panel to play the animation as you create it. Then use the Save For Web & Devices command to preview the animation in your web browser. See “[Preview optimized images in a web browser](#)” on page 512.

10. Optimize the animation for efficient download.

See “[Optimize animation frames](#)” on page 563.

11. Save the animation.

You can save the animation as an animated GIF using the Save For Web & Devices command. You can also save the animation in Photoshop (PSD) format so you can do more work on the animation later.

In Photoshop, you can save your frame animation as an image sequence, QuickTime movie, or as separate files. See also “[Export video files or image sequences](#)” on page 564.

Add frames to an animation

Adding frames is the first step in creating an animation. If you have an image open, the Animation panel displays the image as the first frame in a new animation. Each frame you add starts as a duplicate of the preceding frame. You then make changes to the frame using the Layers panel.



- 1 (Photoshop Extended) Make sure the Animation panel is in frame animation mode.
- 2 Click the Duplicates Selected Frames button  in the Animation panel.

Select animation frames

Before you can work with a frame, you must select it as the current frame. The contents of the current frame appear in the document window.

In the Animation panel, the current frame is indicated by a narrow border (inside the shaded selection highlight) around the frame thumbnail. Selected frames are indicated by a shaded highlight around the frame thumbnails.

Select one animation frame

- 1 (Photoshop Extended) Make sure the Animation panel is in frame animation mode.
- 2 Do one of the following:
 - Click a frame in the Animation panel.
 - In the Animation panel, click the Selects Next Frame button  to select the next frame in the series as the current frame.
 - In the Animation panel, click the Selects Previous Frame button  to select the previous frame in the series as the current frame.
 - In the Animation panel, click the Selects First Frame button  to select the first frame in the series as the current frame.

Select multiple animation frames

- ❖ In the Animation panel (in frame animation mode), do one of the following:
 - To select contiguous multiple frames, Shift-click a second frame. The second frame and all frames between the first and second are added to the selection.
 - To select discontinuous multiple frames, Ctrl-click (Windows) or Command-click (Mac OS) additional frames to add those frames to the selection.
 - To select all frames, choose Select All Frames from the Animation panel menu.
 - To deselect a frame in a multiframe selection, Ctrl-click (Windows) or Command-click (Mac OS) that frame.

Edit animation frames

- 1 In the Animation panel (in frame animation mode), select one or more frames.
- 2 Do any of the following:
 - To edit the content of objects in animation frames, use the Layers panel to modify the layers in the image that affect that frame.
 - To change the position of an object in an animation frame, select the layer containing the object in the Layers panel and drag it to a new position.

Note: In the Animation panel, you can select and change the position of multiple frames. However, if you drag multiple discontinuous frames, the frames are placed contiguously in the new position.

- To reverse the order of animation frames, choose Reverse Frames from the Animation panel menu.

Note: The frames you want to reverse do not have to be contiguous; you can reverse any selected frames.

- To delete selected frames, select Delete Frame from the Animation panel menu or click the Delete icon , then click Yes to confirm the deletion. You can also drag the selected frame onto the Delete icon.

See also



“[Select animation frames](#)” on page 548

Changing attributes of layers in animations

The unify buttons (Unify Layer Position, Unify Layer Visibility, and Unify Layer Style) in the Layers panel determine how the changes you make to attributes in the active animation frame apply to the other frames in the same layer. When a unify button is selected, that attribute is changed in all the frames in the active layer; when that button is deselected, changes apply to only the active frame.

The Propagate Frame 1 option in the Layers panel also determines how the changes you make to attributes in the first frame will apply to the other frames in the same layer. When it is selected, you can change an attribute in the first frame, and all subsequent frames in the active layer will change in relation to the first frame (and preserve the animation you have already created).

Unify layer properties

- 1 In the Animation panel (in frame animation mode), change the attribute to one frame.
- 2 In the Layers panel, click Unify Layer Position , Unify Layer Visibility , or Unify Layer Style  to have the changed attribute apply to all other frames in the active layer.

Propagate frame 1

- 1 In the Layers panel, select the Propagate Frame 1 option.
- 2 In the Animation panel (in frame mode), change the attribute for the first frame.

The changed attribute is applied (in relation) to all subsequent frames in a layer.

 You can also propagate frames by Shift-selecting any consecutive group of frames in the layer and changing an attribute in any of the selected frames.

Show or hide Unify Layers buttons

❖ Choose Animation Options from the Layers panel menu, and then choose one of the following:

Automatic Displays the unify layers buttons when the Animation panel is open. In Photoshop Extended, the Animation panel must be in frame animation mode.

Always Show Displays the unify layers buttons whether the Animation panel is open or closed.

Always Hide Hides the unify layers buttons whether the Animation panel is open or closed.

Copy and paste layers between frames

To understand what happens when you copy and paste a frame, think of a frame as a duplicate version of an image with a given layer configuration. When you copy a frame, you copy the configurations of layers (including each layer's visibility setting, position, and other properties). When you paste a frame, you apply that layer configuration to the destination frame.

- 1 (Photoshop Extended) Make sure the Animation panel is in frame animation mode.
- 2 Select one or more frames you want to copy in the Animation panel.
- 3 Choose Copy Frame(s) from the Animation panel menu.
- 4 Select a destination frame or frames in the current animation or another animation.
- 5 Choose Paste Frame(s) from the Animation panel menu.
- 6 Select a Paste method:

Replace Frames Replaces the selected frames with the copied frames. No new layers are added. The properties of each existing layer in the destination frames are replaced by those of each copied layer. When you paste frames between

images, new layers are added to the image; however, only the pasted layers are visible in the destination frames (the existing layers are hidden).

Paste Over Selection Adds the contents of the pasted frames as new layers in the image. When you paste frames into the same image, using this option doubles the number of layers in the image. In the destination frames, the newly pasted layers are visible, and the original layers are hidden. In the non-destination frames, the newly pasted layers are hidden.

Paste Before Selection or Paste After Selection Adds the copied frames before or after the destination frame. When you paste frames between images, new layers are added to the image; however, only the pasted layers are visible in the new frames (the existing layers are hidden).

7 (Optional) To link pasted layers in the Layers panel, select Link Added Layers.

This option works only when pasting frames into another document. Select it when you plan to reposition the pasted layers as a unit.

8 Click OK.

Create frames using tweening

The term *tweening* is derived from “in betweening,” the traditional animation term used to describe this process. Tweening (also called *interpolating*) significantly reduces the time required to create animation effects such as fading in or fading out, or moving an element across a frame. You can edit tweened frames individually after you create them.

You use the Tween command to automatically add or modify a series of frames between two existing frames—varying the layer properties (position, opacity, or effect parameters) evenly between the new frames to create the appearance of movement. For example, if you want to fade out a layer, set the opacity of the layer in the starting frame to 100%; then set the opacity of the same layer in the ending frame to 0%. When you tween between the two frames, the opacity of the layer is reduced evenly across the new frames.



Using tweening to animate text position

- 1 (Photoshop Extended) Make sure the Animation panel is in frame animation mode.
- 2 To apply tweening to a specific layer, select it in the Layers panel.
- 3 Select a single frame or multiple contiguous frames.
 - If you select a single frame, you choose whether to tween the frame with the previous frame or the next frame.
 - If you select two contiguous frames, new frames are added between the frames.
 - If you select more than two frames, existing frames between the first and last selected frames are altered by the tweening operation.
 - If you select the first and last frames in an animation, these frames are treated as contiguous, and tweened frames are added after the last frame. (This tweening method is useful when the animation is set to loop multiple times.)
- 4 Do one of the following:
 - Click the Tweens button  in the Animation panel.
 - Select Tween from the Animation panel menu.

5 Specify the layer or layers to be varied in the added frames:

All Layers Varies all layers in the selected frame or frames.

Selected Layer Varies only the currently selected layer in the selected frame or frames.

6 Specify layer properties to be varied:

Position Varies the position of the layer's content in the new frames evenly between the beginning and ending frames.

Opacity Varies the opacity of the new frames evenly between the beginning and ending frames.

Effects Varies the parameter settings of layer effects evenly between the beginning and ending frames.

7 If you selected a single frame in step 3, choose where to add frames from the Tween With menu:

Next Frame Adds frames between the selected frame and the following frame. This option is not available when you select the last frame in the Animation panel.

First Frame Adds frames between the last frame and first frame. This option is available only if you select the last frame in the Animation panel.

Previous Frame Adds frames between the selected frame and the preceding frame. This option is not available when you select the first frame in the Animation panel.

Last Frame Adds frames between the first frame and last frame. This option is available only if you select the first frame in the Animation panel.

8 In the Frames To Add box, enter a value, or use the Up or Down Arrow key to choose the number of frames.
(This option is not available if you selected more than two frames.)

9 Click OK.

Add a new layer every time you create a frame

When you create a new layer, it is visible in all frames of an animation. To hide a layer in a specific frame, select the frame in the Animation panel, and then hide the desired layer in the Layers panel.

You can use the Create New Layer For Each New Frame command to automatically add a new layer to the image every time you create a frame. The new layer is visible in the new frame but hidden in other frames. Using this option saves time when you are creating an animation that requires you to add a new visual element to each frame.

1 (Photoshop Extended) Make sure the Animation panel is in frame animation mode.

2 From the Animation panel menu, choose Create New Layer For Each New Frame.

A check mark indicates that the option is turned on.

Specify a delay time in frame animations

You can specify a *delay*—the time that a frame is displayed—for single frames or for multiple frames in an animation. Delay time is displayed in seconds. Fractions of a second are displayed as decimal values. For example, one-quarter of a second is specified as .25. If you set a delay on the current frame, every frame you create after that will remember and apply that delay value.

1 (Photoshop Extended) Make sure the Animation panel is in frame animation mode.

2 Select one or more frames.

3 In the Animation panel, click the Delay value below the selected frame to view the pop-up menu.

4 Specify the delay:

- Choose a value from the pop-up menu. (The last value used appears at the bottom of the menu.)
- Choose Other, enter a value in the Set Frame Delay dialog box, and click OK. If you selected multiple frames, specifying a delay value for one frame applies the value to all frames.



Choose a disposal method

The frame disposal method specifies whether to discard the current frame before displaying the next frame. You select a disposal method for animations that include background transparency to specify whether the current frame will be visible through the transparent areas of the next frame.



Frame disposal methods

A. Frame with background transparency with Restore To Background option B. Frame with background transparency with Do Not Dispose option

The Disposal Method icon indicates whether the frame is set to Do Not Dispose  or Dispose . (No icon appears when Disposal Method is set to Automatic.)

- 1 (Photoshop Extended) Make sure the Animation panel is in frame animation mode.
- 2 Select a frame or frames for which you want to choose a disposal method.
- 3 Right-click (Windows) or Control-click (Mac OS) the frame thumbnail to view the Disposal Method context menu.
- 4 Choose a disposal method:

Automatic Determines a disposal method for the current frame automatically, discarding the current frame if the next frame contains layer transparency. For most animations, the Automatic option (default) yields the desired results.

Note: To enable Photoshop to preserve frames that include transparency, select the Automatic disposal option when you are using the Redundant Pixel Removal optimization option.

Do Not Dispose Preserves the current frame as the next frame is added to the display. The current frame (and preceding frames) may show through transparent areas of the next frame. Use a browser to see an accurate preview of an animation using the Do Not Dispose option.

Dispose Discards the current frame from the display before the next frame is displayed. Only a single frame is displayed at any time (and the current frame does not appear through the transparent areas of the next frame).

Specify looping in frame animations

You select a looping option to specify how many times the animation sequence repeats when played.

- 1 (Photoshop Extended) Make sure the Animation panel is in frame animation mode.
- 2 Click the Looping Option Selection box at the lower left corner of the Animation panel.
- 3 Select a looping option: Once, 3 Times, Forever, or Other.
- 4 If you selected Other, enter a value in the Set Loop Count dialog box, and click OK.

Note: Looping options can also be set in the Save For Web & Devices dialog box. For more information, see “[Save For Web & Devices overview](#)” on page 507.

See also

“[Save a file in GIF format](#)” on page 454

“[Photoshop format \(PSD\)](#)” on page 458

Delete an entire animation

- 1 (Photoshop Extended) Make sure the Animation panel is in frame animation mode.
- 2 Select Delete Animation from the Animation panel menu.

Creating timeline animations (Photoshop Extended)

Timeline animation workflow (Photoshop Extended)

To animate layer content in timeline mode (rather than frame mode), you set keyframes in the Animation panel, as you move the current-time indicator to a different time/frame, and then modify the position, opacity, or style of the layer content. Photoshop automatically adds or modifies a series of frames between two existing frames—varying the layer properties (position, opacity, and styles) evenly between the new frames to create the appearance of movement or transformation.

For example, if you want to fade out a layer, set the opacity of the layer in the starting frame to 100% and in the Animation panel, click the Opacity stopwatch for the layer. Then move the current-time indicator to the time/frame for the ending frame and set the opacity for the same layer to 0%. Photoshop Extended automatically interpolates frames between the start and end frames, and the opacity of the layer is reduced evenly across the new frames.

In addition to letting Photoshop interpolate frames in an animation, you can also create a hand-drawn frame-by-frame animation by painting on a blank video layer.

 *If you want to create a SWF format animation, use Adobe Flash, Adobe After Effects, or Adobe Illustrator.*

To create a timeline-based animation in Photoshop Extended, use the following general workflow.

1. Create a new document.

Specify the size and background contents. Make sure the pixel aspect ratio and dimensions are appropriate for the output of your animation. The color mode should be RGB. Unless you have special reasons for making changes, leave the resolution at 72 pixels/inch, the bit depth at 8 bpc, and the pixel aspect ratio at square.

2. Specify the document timeline settings in the Animation panel menu.

Specify the duration and frame rate. See “[Specify timeline duration and frame rate \(Photoshop Extended\)](#)” on page 532.

3. Add a layer.

Add any of the following:

- A new layer for adding content.

- A new video layer for adding video content.
- A new blank video layer for cloning content to or creating hand-drawn animations.

4. Add content to the layer.

5. (Optional) Add a layer mask.

A layer mask can be used to reveal only a portion of the layer's content. You can animate the layer mask to reveal different portions of the layer's content over time. See [“Add layer masks”](#) on page 320.

6. Move the current time indicator to the time or frame where you want to set the first keyframe.

See [“Use keyframes to animate layer properties \(Photoshop Extended\)”](#) on page 556.

7. Turn on keyframing for a layer property.

Click the triangle next to the layer name. A down-pointing triangle displays the layer's properties. Then, click the stopwatch to set the first keyframe for the layer property you want to animate. You can set keyframes for more than one layer property at a time.

8. Move the current time indicator and change a layer property.

Move the current-time indicator to the time or frame where the layer's property changes. You can do one or more of the following:

- Change the position of the layer to make layer content move.
- Change layer opacity to make content fade in or out.
- Change the position of a layer mask to reveal different parts of the layer.
- Turn a layer mask on or off.

For some types of animation, such as changing the color of an object, or completely changing the content in a frame, you need additional layers with the new content.

Note: To animate shapes, you animate the vector mask not the shape layer, using the Time-Vary stopwatch for Vector Mask Position or Vector Mask Enable.

9. Add additional layers with content and edit their layer properties as needed.

10. Move or trim the layer duration bar to specify when a layer appears in an animation.

See [“Specify when a layer appears in a video or animation \(Photoshop Extended\)”](#) on page 544 and [“Set the timeline area to preview \(Photoshop Extended\)”](#) on page 560.

11. Preview the animation.

Use the controls in the Animation panel to play the animation as you create it. Then preview the animation in your web browser. You can also preview the animation in the Save For Web & Devices dialog box. See [“Previewing video or timeline animations \(Photoshop Extended\)”](#) on page 561.

12. Save the animation.

You can save the animation as an animated GIF using the Save For Web & Devices command, or as an image sequence or video using the Render Video command. You can also save it in PSD format, which can be imported into Adobe After Effects.

See also

“Switch animation modes (Photoshop Extended)” on page 531

“Choose interpolation method (Photoshop Extended)” on page 556

“Create hand-drawn animations (Photoshop Extended)” on page 558

Use keyframes to animate layer properties (Photoshop Extended)

You can animate different layer properties, such as Position, Opacity, and Style. Each change can occur independently of, or simultaneously with, other changes. If you want to animate different objects independently, it's best to create them on separate layers.

For a video on creating animations from images, see www.adobe.com/go/vid0024.

Here are some examples of how you can animate layer properties:

- You can animate position by adding a keyframe to the Position property, then moving the current time indicator and dragging the layer in the document window.
- You can animate a layer's opacity by adding a keyframe to the Opacity property, then moving the current time indicator and changing the layer's opacity in the Layers panel.
- You can animate 3D properties, such as object and camera position. (For more information, see “Create 3D animations (Photoshop Extended)” on page 592.)

To animate a property using keyframes, you must set at least two keyframes for that property. Otherwise, changes that you make to the layer property remain in effect for the duration of the layer.

Each layer property has a Time-Vary stopwatch icon  that you click to begin animating. When the stopwatch is active for a specific property, Photoshop automatically sets new keyframes whenever you change the current time and the property value. When the stopwatch is inactive for a property, the property has no keyframes. If you type a value for a layer property while the stopwatch is inactive, the value remains in effect for the duration of the layer. If you deselect the stopwatch, you will permanently delete all of the keyframes for that property.

Choose interpolation method (Photoshop Extended)

Interpolation (sometimes called *tweening*) describes the process of filling in unknown values between two known values. In digital video and film, interpolation usually means generating new values between two keyframes. For example, to move a graphic element 50 pixels to the left in 15 frames, you'd set the position of the graphic in the first and 15th frames, and mark them both as keyframes. Photoshop interpolates the frames between the two keyframes. Interpolation between keyframes can be used to animate movement, opacity, styles, and global lighting.

In the Animation panel, the appearance of a keyframe depends on the interpolation method you choose for the interval between keyframes.

Linear keyframe  Evenly changes the animated property from one keyframe to another. (The one exception is the Layer Mask Position property which switches between enabled and disabled states abruptly.)

Hold keyframe  Maintains the current property setting. This interpolation method is useful for strobe effects, or when you want layers to appear or disappear suddenly.

To choose the interpolation method for a keyframe, do the following:

- 1 In the Animation panel, select one or more keyframes.
- 2 Do one of the following:
 - Right-click a selected keyframe and choose either Linear Interpolation or Hold Interpolation from the Context menu.

- Open the Animation panel menu and choose either Keyframe Interpolation > Linear or Keyframe Interpolation > Hold.

See also

“Use keyframes to animate layer properties (Photoshop Extended)” on page 556

[Creating animations from shape tweens](#)

Move the current-time indicator to a keyframe (Photoshop Extended)

After you set the initial keyframe for a property, Photoshop displays the keyframe navigator, which you can use to move from keyframe to keyframe or to set or remove keyframes. When the keyframe navigator diamond is active (yellow), the current-time indicator lies precisely at a keyframe for that layer property. When the keyframe navigator diamond is inactive (gray), the current-time indicator lies between keyframes. When arrows appear on each side of the keyframe navigator box, other keyframes for that property exist on both sides of the current time.

- ❖ Click a keyframe navigator arrow. The arrow to the left moves the current-time indicator to the previous keyframe. The arrow to the right moves the current-time indicator to the next keyframe.

Select keyframes (Photoshop Extended)

- ❖ In the Animation panel, do any of the following:
 - To select a keyframe, click the keyframe icon.
 - To select multiple keyframes, Shift-click the keyframes or drag a selection marquee around the keyframes.
 - To select all keyframes for a layer property, click the layer property name next to the stopwatch icon.

Move keyframes (Photoshop Extended)

- 1 Select one or more keyframes.
- 2 Drag any of the selected keyframe icons to the desired time. (If you selected multiple keyframes, they move as a group and maintain the same time spacing.)

 *To expand or compress the spacing of multiple keyframes, Alt-drag (Windows) or Option-drag (Mac OS) the first or last keyframe in the selection. The keyframe at the opposite end of the selection remains in place as you drag, slowing down or speeding up the animation.*

Copy and paste keyframes (Photoshop Extended)

You can copy keyframes for a property (such as Position) to the same property in any layer. When you paste keyframes, they reflect the copied offset from the current-time indicator.

You can copy keyframes from only one layer at a time. When you paste keyframes into another layer, they appear in the corresponding property in the destination layer. The earliest keyframe appears at the current time, and the other keyframes follow in relative order. The keyframes remain selected after pasting, so you can immediately move them in the timeline.

Note: *You can copy and paste keyframes between more than one property at a time.*

- 1 In the Animation panel, display the layer property containing the keyframes you want to copy.
- 2 Select one or more keyframes.
- 3 Right-click a selected keyframe, and choose Copy Keyframes.
- 4 In the Animation panel containing the destination layer, move the current-time indicator to the point in time where you want the keyframes to appear.

- 5 Select the destination layer.
- 6 Open the Animation panel menu and choose Paste Keyframes.

Delete keyframes (Photoshop Extended)

- ❖ Select one or more keyframes and do one of the following:
 - Right-click (Windows) or Control-click (Mac OS) a selected keyframe, and choose Delete Keyframes from the context menu.
 - From the Animation panel menu, choose Delete Keyframes.

Create hand-drawn animations (Photoshop Extended)

You can add a blank video layer to your document when you want to create frame-by-frame hand-drawn animations. Adding a blank video layer above a video layer and then adjusting the opacity of the blank video layer, allows you to see the contents of the video layer below. You can then rotoscope the video layer content by painting or drawing on the blank video layer. See also “[Paint frames in video layers \(Photoshop Extended\)](#)” on page 540.

Note: If you're animating several independent elements, create separate content on different blank video layers.

- 1 Create a new document.
- 2 Add a blank video layer.
- 3 Paint or add content to the layer.
- 4 (Optional) Click the Toggle Onion Skins button  to enable onion skinning.
- 5 Move the current-time indicator to the next frame.
- 6 Paint or add content to the layer in a slightly different position from the content in the previous frame.

 You can add a blank video frame, duplicate a frame, or delete a frame from the blank video layer by choosing Layer > Video Layers and then choosing the appropriate command.

As you create more hand-drawn frames, you can either drag the current time indicator or use the playback controls in the Animation panel to preview your animation.

Insert, delete, or duplicate blank video frames (Photoshop Extended)

A blank video frame can be added to or removed from a blank video layer. You can also duplicate existing (painted) frames in blank video layers.

- 1 In the Animation panel, select the blank video layer and then move the current-time indicator to the desired frame.
- 2 Choose Layer > Video Layers and then choose one of the following:

Insert Blank Frame Inserts a blank video frame in the selected blank video layer at the current time.

Delete Frame Deletes the video frame in the selected blank video layer at the current time.

Duplicate Frame Adds a copy of the video frame at the current time in the selected blank video layer.

Specify onion skin settings (Photoshop Extended)

Onion skin mode displays content drawn on the current frame plus content drawn on the surrounding frames. These additional frames appear at the opacity you specify to distinguish them from the current frame. Onion skin mode is useful for drawing frame-by-frame animations because it gives you reference points for stroke positions and other edits.

Onion skin settings specify how previous and later frames appear when Onion Skins are enabled in the Animation panel. (See “[Animation panel overview](#)” on page 529.)

- 1 Open the Animation panel menu and choose Onion Skin Settings.
- 2 Specify options for the following:

Onion Skin Count Specifies how many previous and forward frames are displayed. Enter the Frames Before (previous frames) and Frames After (forward frames) values in the text boxes.

Frame Spacing Specifies the number of frames between the displayed frames. For example, a value of 1 displays consecutive frames, and a value of 2 displays strokes that are two frames apart.

Max Opacity Sets the percentage of opacity for the frames immediately before and after the current time.

Min Opacity Sets the percentage of opacity for the last frames of the before and after sets of onion-skin frames.

Blend Mode Sets the appearance of the areas where the frames overlap.

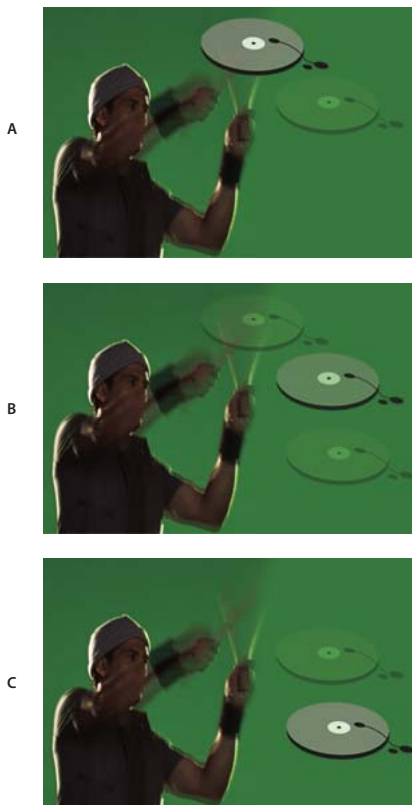

Onion skinning

A. Current frame with one frame after B. Current frame with both one frame before and after C. Current frame with one frame before

See also

“[List of blending modes](#)” on page 347

Open a multilayer animation

You can open animations that were saved in older versions of Photoshop as multilayer Photoshop (PSD) files. The layers are placed in the Animation panel in their stacking order, with the bottom layer becoming the first frame.

- 1 Choose File > Open, and select the Photoshop file to open.

- 2 In the Layers panel, select the layers you want for the animation, and choose Make Frames From Layers from the Animation panel menu.

You can edit the animation, use the Save For Web & Devices command to save an animated GIF, or use the Render Video command to save the animation as a QuickTime movie.

Previewing video and animations

Preview a frame animation

- 1 Do one of the following:
 - Click the Play button ► in the Animation panel.
 - Use the spacebar to play and pause the animation.

The animation is displayed in the document window. The animation repeats indefinitely unless you specified another repeat value in the Play Options dialog box.

- 2 To stop the animation, click the Stop button ■.
- 3 To rewind the animation, click the Selects First Frame button ◀◀.

Note: To see a more accurate preview of the animation and timing, preview the animation in a web browser. In Photoshop, open the Save For Web & Devices dialog box and click the Preview In Browser button. Use the browser's Stop and Reload commands to stop or replay the animation.

See also

“[Preview optimized images in a web browser](#)” on page 512

Set the timeline area to preview (Photoshop Extended)

- 1 To set the timeline duration you want to export or preview, do any of the following in the Animation panel:
 - Drag either end of work area bar.

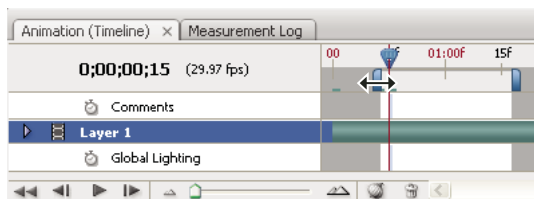

Dragging an end of the work area bar

- Drag the work area bar over the section you want to preview.
 - Move the current-time indicator to the time or frame you want. From the Animation panel menu, choose either Set Start Of Work Area or Set End Of Work Area.
- 2 (Optional) To remove the portions of the timeline not in the work area, choose Trim Document Duration To Work Area from the Animation panel menu.

See also

“[Specify timeline duration and frame rate \(Photoshop Extended\)](#)” on page 532

Previewing video or timeline animations (Photoshop Extended)

Your video or animation can be previewed in the document window. Photoshop uses RAM to preview the video or animation during your editing session. When you play or drag to preview frames, they are automatically cached for faster playback the next time they're played. The cached frames are indicated by the green bar in the work area of the Animation panel. The number of frames cached depends on the amount of RAM available to Photoshop.

Preview a video or timeline animation (Photoshop Extended)

- ❖ Do any of the following:
 - In the timeline, drag the current-time indicator.
 - Use the playback buttons at the bottom of the Animation panel.
 - Press the spacebar to play or stop playback. For additional shortcuts, see “[Keys for using the Animation panel in Timeline Mode \(Photoshop Extended\)](#)” on page 666.

 *To see a more accurate preview of an animation created for the web, preview the animation in a web browser. Use the browser's Stop and Reload commands to stop or replay the animation. Open the Save For Web & Devices dialog box, and click the Preview In Browser button.*

Preview audio for video layers (Photoshop Extended)

When you enable audio previews for video layers, Photoshop Extended includes the audio in files exported to QuickTime Movie format. (See “[Export video files or image sequences](#)” on page 564.)

In the Animation panel, do either of the following:

- To enable or disable audio previews for a specific video layer, click the speaker icon  for that layer.
- To enable or disable audio previews for an entire document, click the speaker icon to the right of the playback buttons at the bottom of the panel.

Enable frame skipping (Photoshop Extended)

Photoshop Extended can skip uncached frames to achieve real-time playback.

- ❖ With the Animation panel in timeline animation mode, click the panel options icon , and choose Allow Frame Skipping.

Preview your document on a video monitor

The Video Preview plug-in lets you preview the current frame specified in the Animation timeline (or any image open in Photoshop) through FireWire (IEEE 1394) on a display device, such as a video monitor. You can also adjust the aspect ratio for proper display of images.

Note: *On 64-bit operating systems, you must use the 32-bit version of Photoshop to access the Video Preview plug-in.*

The Video Preview plug-in supports RGB, grayscale, and indexed images. (The plug-in converts 16-bpc images to 8-bpc images.) The Video Preview plug-in does not support alpha channels. Transparency is displayed as black.

Note: *The Video Preview plug-in does not lock the display device. When Photoshop is in the background on your computer and another application moves into the foreground, the preview turns off and the device is unlocked so other applications can use it for preview purposes.*

- 1 Connect a display device, such as a video monitor, to your computer via FireWire (IEEE 1394).

2 With a document open in Photoshop, do one of the following:

- If you don't want to set output options for viewing your document on a device, choose File > Export > Send Video Preview To Device. You can skip the rest of the steps in this procedure.
- To set output options before viewing your document on the device, choose File > Export > Video Preview.

The Video Preview dialog box opens. If your document's pixel aspect ratio doesn't match the aspect ratio settings of the display device, you will see an alert.

Note: The Send Video Preview To Device command uses the previous settings in the Video Preview dialog box.

3 Under Device Settings, specify options for the device that will display the image:

- (Mac OS) To specify an output mode, select NTSC or PAL. If the output mode and the device do not match (for example, specifying NTSC for the output mode and connecting to a device in PAL mode), black patches appear on previewing.
- To specify the aspect ratio of the display device, choose either Standard (4:3) or Widescreen (16:9) from the Aspect Ratio menu.

Note: The Aspect Ratio setting determines which placement options are available.

4 Under Image Options, choose a placement option to determine how the image appears in the display device:

Center Places the center of the image at the center of the screen, cropping the portions that fall outside the display edges of the video preview device.

Pillarbox Displays a 4:3 image on a 16:9 display with the center of the image at the center of the screen and gray bands on the left and right sides of the image. This option is available only if you chose Widescreen (16:9) for the device aspect ratio.

Crop to 4:3 Displays a 16:9 image on a 4:3 display with the center of the image at the center of the screen and without distortion by cropping the left and right edges of the frame that fall outside the display edges of the video preview device. This option is available only if you chose Standard (4:3) for the device aspect ratio.

Letterbox Scales a 16:9 image to fit on a 4:3 display. Gray bands appear on the top and bottom of the image due the difference in aspect ratio between the 16:9 image and the 4:3 display. This maintains the display aspect ratio without cropping or distorting the image. This option is available only if you chose Standard (4:3) for the device aspect ratio.

Crop To 14:9/Letterbox Displays a widescreen image cropped to a 14:9 aspect ratio with black bands on either the top and bottom of the image (when viewed on a 4:3 display) or on the left and right sides (when viewed on a 16:9 display). This maintains the display aspect ratio without distorting the image.

5 Choose an option from the Image Size menu to control whether the document pixels are scaled to the device display:

Do Not Scale Applies no vertical scaling to the image. The image is cropped if its height is greater than that of the video display.

Scale To Fit Within Frame Increases or decreases the image height and width proportionally to fit in the video frame. With this option, a 16:9 image appears on a 4:3 display as letterbox, and a 4:3 image appears on a 16:9 display as pillarbox.

6 Select the Apply Pixel Aspect Ratio To Preview check box to display the image using the document's (nonsquare) pixel aspect ratio. Deselect this option to display the image as it appears on your computer (square pixel) monitor.

By default, the Apply Pixel Aspect Ratio To Preview check box is selected to maintain the image's pixel aspect ratio. In general, you would deselect this option if the document's pixel aspect ratio is assumed to be square and you want to view the image as it would appear on a computer (square pixel) monitor.

7 Click OK to export the document to the device display.

Saving and exporting video and animations

Video and animation export formats

You can save animations as GIF files for viewing on the web. In Photoshop Extended, videos and animations can be saved as QuickTime movies or PSD files. If you're not rendering your work to video, then saving the file as PSD is best because it preserves the edits and saves the file in a format that's supported by Adobe digital video applications and many motion picture editing applications.

For a video on working with image sequences, see www.adobe.com/go/vid0026.

Optimize animation frames

After you complete your animation, you should optimize it for efficient download to a web browser. You optimize an animation in two ways:

- Optimize the frames to include only areas that change from frame to frame. This greatly reduces the file size of the animated GIF file.
- If you are saving your animation as a GIF image, optimize it as you would any GIF image. A special dithering technique is applied to animations to ensure that dither patterns are consistent across all frames and to prevent flickering during playback. Due to these additional optimization functions, more time may be required to optimize an animated GIF than to optimize a standard GIF.

 *When optimizing the colors in an animation, use the Adaptive, Perceptual, or Selective palette. This ensures that the colors are consistent across frames.*

- 1 (Photoshop Extended) Make sure the Animation panel is in frame animation mode.
- 2 Choose Optimize Animation from the Animation panel menu.
- 3 Set the following options:

Bounding Box Crops each frame to the area that has changed from the preceding frame. Animation files created using this option are smaller but are incompatible with GIF editors that do not support the option. (This option is selected by default and is recommended.)

Redundant Pixel Removal Makes all pixels transparent in a frame that are unchanged from the preceding frame. The Transparency option in the Optimize panel must be selected for redundant pixel removal to work. (This option is selected by default and is recommended.)

Important: Set the frame disposal method to Automatic when using the Redundant Pixel Removal option. (See “[Choose a disposal method](#)” on page 553.)

- 4 Click OK.

See also

“[Optimize an image for the web](#)” on page 508

“[GIF and PNG-8 optimization options](#)” on page 513

Flatten frames into layers

When you flatten frames into layers, a single layer is created for each frame in a video layer. This can be useful, for example, if you're exporting the individual video frames as separate image files, or if you're planning to use the video of a static object in an image stack.

- 1 In the Animation or Layers panel, select the video layer.
- 2 In the Animation panel, choose Flatten Frames Into Layers from the Panel menu.

See also

["Image Stacks \(Photoshop Extended\)"](#) on page 611

Export video files or image sequences

Note: In Photoshop, you can export QuickTime or image sequences. In Photoshop Extended, you can also export timeline animations with video layers.

- 1 Choose File > Export > Render Video.
- 2 In the Render Video dialog box, enter a name for the video or image sequence.
- 3 Click the Select Folder button, and navigate to the location for the exported files.

To create a folder to contain your exported file, select the Create New Subfolder option and enter a name for the subfolder.

- 4 Under File Options, select either QuickTime Export or Image Sequence. Then choose a file format from the pop-up menu.
- 5 (Optional) Click Settings to specify format-specific options.
- 6 (Optional) If you chose Image Sequence in step 4, specify the Starting and Digits numbers. (These options specify the numbering system for the exported files.) Use the Size pop-up menu to specify the pixel dimensions for the exported files.
- 7 Under Range, select one of the following options:

All Frames Renders all the frames in the Photoshop document.

In Frame and Out Frame Specify the sequence of frames to render.

Currently Selected Frames Renders the frames selected by the work area bar in the Animation panel.

- 8 (Optional) Specify render options:

Alpha Channel Specifies how alpha channels are rendered. (This option is available only with formats that support alpha channels, such as PSD or TIFF). Select None to ignore the alpha channel, Straight-Unmatted to include the channel, or one of the Premultiplied options to mix a matte color with the color channels.

Frame Rate Determines how many frames are created for each second of the video or animation. The Document Frame Rate option reflects the rate in Photoshop. If you're exporting to a different video standard (from NTSC to PAL, for example), choose the appropriate rate from the pop-up menu.

- 9 Click Render.

See also

[“Saving and exporting images”](#) on page 440

[“Interpret video footage \(Photoshop Extended\)”](#) on page 539

[Working with Image Sequences video](#)

QuickTime export file formats

3G A file format developed for third-generation mobile devices.

FLC An animation format for playback of computer-generated animations on workstations, Windows, and Mac OS. This format is also referred to as FLI.

Flash Video (FLV) Adobe® Flash® Video is the Adobe format for streaming audio and video over the web and other networks. (To use this format, you must first install an FLV QuickTime encoder).

QuickTime Movie The Apple Computer multimedia architecture that includes a number of codecs. (To export audio, you must use this format.)

AVI Audio Video Interleave (AVI) is a standard format for audio and video data on Windows computers.

DV Stream A video format with intraframe compression that uses FireWire (IEEE 1394) interface to transfer video to nonlinear editing systems.

Image Sequence A sequence of still images that can reside within one folder and use the same numeric or alphabetic filename pattern (such as Sequence1, Sequence2, Sequence3, and so forth).

MPEG-4 A multimedia standard for delivering audio and video streams over a range of bandwidths.

Note: Photoshop also supports other third-party formats such as Avid AVR codecs; however, the necessary QuickTime codecs must be installed.

Understanding QuickTime key frames

In QuickTime terminology, the term *key frames* refers to something different than the animation keyframes in Photoshop. In QuickTime, key frames occur at regular intervals in the movie and are stored as complete frames. Each intermediate frame that separates them is compared to the previous frame, and only changed data is stored. Using key frames greatly reduces movie size and greatly increases the memory required to edit and render a movie. Shorter intervals between key frames enable faster seeking and reverse playback, but can significantly increase the size of the file.

3G export settings

For more information on 3G settings, search for 3G on the Apple Computer web site.

File Format 3GPP and 3GPP2 are standards for the creation, delivery, and playback of multimedia over third-generation high-speed wireless networks. 3GPP is for GSM networks and 3GPP2 is for CDMA 2000 networks. 3GPP (Mobile MP4), 3GPP2 (EZmovie), and AMC (EZmovie) are for specific networks. 3GPP (Mobile MP4) is for NTT DoCoMo’s i-motion 3G service. 3GPP2 (EZmovie) is for KDDI’s 3G network service. AMC (EZmovie) is for KDDI subscribers with AMC-capable phones.

Video Choose Video from the pop-up menu below the File Format menu and specify the following:

- **Video Format** Selects the codec used during video export. If your source movie has only one video track and it is already compressed, you can choose Pass Through so that the video doesn’t get compressed again.
- **Data Rate** Specifies the kilobits per second (kbps) during playback. A higher kbps rate usually improves movie playback quality; however, don’t choose a data rate higher than the available bandwidth.

- **Optimized For** Specifies the intended delivery method if you choose H.264 from the Video Format menu, click Video Options, and select Best Quality. This setting tells the codec how much the data rate can vary above and below the data rate you choose.
- **Image Size** Specifies a standard for sending the file to a mobile phone. Current maintains the source material size; the resulting file may not play on a mobile phone. Choose Custom to specify a size not listed in the menu.
- **Preserve Aspect Ratio Using** Specifies an option when you're changing the image size and the movie needs to be scaled to the new dimensions. Letterbox scales the source proportionally to fit into the clean aperture, adding black bars to the top and bottom or sides as necessary. Crop centers, scales, and trims to the clean aperture.
- **Frame Rate** Specifies the frames per second (fps) during playback. In most cases, your video will look better if you choose a number that your source fps is exactly divisible by. For example, if your source is captured at 30 fps, choose a frame rate of 10 or 15. Don't choose a rate larger than that of your source material.
- **Key Frame** Specifies how frequently key frames are created in the exported video. A higher key frame rate (lower number) improves video quality, but increases the file size.
- **Video Options** If available, click the Video Options button to open the 3G Advanced Video Settings dialog box. Depending on the video, you can specify whether to add re-sync markers inside the video frames to help with packet loss recovery when streaming. With H.264 video, you can also speed up the compression process (for preview purposes, for example) by choosing Faster Encode (Single-pass). The default option, Best Quality (Multi-pass), allows the codec to determine how many passes are needed to compress the data for the best quality.

Audio All audio options are disabled because Photoshop Extended does not include audio in exported 3G files.

Text All text options are disabled because Photoshop Extended does not include text tracks in exported 3G files.

Streaming Choose Streaming from the pop-up menu below the File Format menu and specify the following:

- **Enable Streaming** Creates a file for RTSP streaming to QuickTime Player. This option creates a hint track (instructions necessary for streaming a file).
- **Optimize For Server** Helps the server to process the file faster, but increases the file size.

Advanced Choose Advanced from the pop-up menu below the File Format menu and specify the following:

- **Restrict Distribution** Specifies how many times the file can play back on the handset once downloaded. Also specifies file expiration options: set the file to expire in a number of days or enter a date. If your file is in Mobile MP4 or EZmovie format, you can restrict distribution so that once the file is on a handset it can't be sent or copied elsewhere.
- **Fragment Movie** Enables the file to download via HTTP in small pieces so that playback can start faster and so that larger files can be played on the handset (only the fragment, not the entire movie, must fit on the handset at one time).

FLC export settings

The following options are available in the FLC Export Settings dialog box:

Color Table Specifies the color table using the Windows system colors or Mac OS system colors in the exported movie.

Motion Sets the playback frame rate.

Specify AVI export settings

- 1 In the Render Video dialog box, select QuickTime Export and then choose AVI from the pop-up menu.
- 2 Click the Settings button.
- 3 In the AVI Settings dialog box, make sure Video is selected.

Important: Sound options are disabled because Photoshop Extended does not include audio in exported AVI files.

4 Under Video, click the Settings button and set the following:

Compression Type Chooses the video compressor (codec) to compress your video.

Frame Per Second Specifies the number of individual images shown every second. NTSC is generally the standard video format and is 29.97 fps. PAL is a European video format that is 25 fps. The standard for film is 24 fps. QuickTime movies are sometimes created with a slower frame rate to reduce bandwidth and CPU requirements.

Movies with higher frame rates display motion better, but have larger file sizes. If you choose a frame rate that's lower than the movie's current frame rate, frames are deleted. If you choose a number that's higher than the movie's current frame rate, existing frames are duplicated (not recommended, since it increases file size without improving quality). In most cases, your video will look better if you choose a number that your source fps is exactly divisible by. For example, if your source is captured at 30 fps, choose a frame rate of 10 or 15. Don't choose a rate larger than that of your source material.

Key Frame Every Specifies the key frame frequency. A higher key frame rate (lower number) improves video quality, but increases the file size. With some compressors, an additional key frame is inserted automatically if too much of the image has changed from one frame to the next. In general, one key frame every 5 seconds (multiply the frames per second by 5) is usually sufficient. If you are creating a file for RTSP streaming and have concerns about the reliability of the delivery network, you may want to increase key frame frequency to one key frame every 1 or 2 seconds.

Limit Data Rate To Specifies the kilobits per second (kbps) during playback. A higher kbps rate usually improves movie playback quality; however, don't choose a data rate higher than the available bandwidth.

Depth Specifies the number of colors to include in video that you export. This menu is not available if the selected codec supports only one color depth.

Quality If available, drag the slider or type a value to adjust the exported video's picture quality and, consequently, its file size. If you are using the same codec to capture and export, and you've rendered previews of a sequence, you can save rendering time by matching the export quality setting with your original capture quality setting. Increasing quality above the original capture quality does not increase quality, but may result in longer rendering times.

Scan Mode Specifies whether the exported movie has fields (Interlaced) or no fields (Progressive).

Aspect Ratio Specifies a 4:3 or 16:9 aspect ratio for the exported movie.

Options (Intel Indeo® Video 4.4 only) Sets compression, transparency options, and access for the Intel Indeo® Video 4.4 codec.

DV Stream export settings

The following options are available in the DV Export Settings dialog box:

DV Format Specifies either the DV or DVCPRO format for your exported video.

Video Format Specifies either NTSC or PAL video broadcast standard.

Scan Mode Specifies whether the exported video has interlaced fields or no fields (Progressive Scan).

Aspect Ratio Specifies an aspect ratio of 4:3 or 16:9.

Preserve Aspect Ratio Using Specifies an option if the movie is scaled to new pixel dimensions. Letterbox scales the source proportionally to fit into the clean aperture, adding black bars to the top and bottom or sides as necessary. Crop centers, scales, and trims to the clean aperture.

Important: Although the DV Export Settings dialog box has Audio Format options, Photoshop Extended CS4 does not export audio in DV files.

Image sequence settings for QuickTime export

Typically, QuickTime is used to export video files. However, you can also select Image Sequence from the QuickTime Export pop-up menu. Click Settings to access the following options:

Format Chooses a file format for the exported images.

Frames Per Second Sets the frame rate for the image sequence.

Insert Space Before Number Inserts a space between the name and generated number in the image's filename.

Options If available, click the Options button and set format-specific options.

For more information on the specific file formats and their options, see also “[Saving and exporting files in other formats](#)” on page 452 and “[File formats](#)” on page 457.

For a video on working with image sequences, see www.adobe.com/go/vid0026.

Specify MPEG-4 export settings (Photoshop Extended)

- 1 In the Render Video dialog box, select QuickTime Export, and choose MPEG-4 from the pop-up menu. Then click Settings.
- 2 In the MPEG-4 Export Settings dialog box, choose MP4 or MP4 (ISMA) from the File Format menu. The MP4 (ISMA) format ensures operability with devices made by ISMA members.
- 3 Under Video, specify the following:

Video Format Chooses the codec to compress your video. For the highest quality at the lowest data rate (or the smallest file), H.264 is recommended. If you need the file to play on a device that supports MPEG-4 video, choose MPEG-4 Basic or MPEG-4 Improved, depending on the target device. If your source movie's video track is already compressed, you can choose Pass Through so that the video doesn't get compressed again.

Data Rate Specifies the kilobits per second (kbps) during playback. A higher kbps rate usually improves movie playback quality; however, don't choose a data rate higher than the available bandwidth.

Optimized For Specifies how much the data rate can vary above and below the data rate you choose. This option becomes available if you choose MP4 from the File Format menu, choose H.264 from the Video Format menu, click Video Options, and select Best Quality.

Image Size Specifies the pixel dimensions of your exported video. Current maintains the source material size. To specify a size not listed in the Image Size menu, choose Custom.

Preserve Aspect Ratio Using Specifies an option if the movie needs to be scaled to the new pixel dimensions. Letterbox scales the source proportionally to fit into the clean aperture, adding black bars to the top and bottom or sides as necessary. Crop centers, scales, and trims to the clean aperture. Fit Within Size adjusts to the destination size by fitting to the longest side, scaling if necessary.

Frame Rate Specifies the frame rate for the playback of your exported video. Usually, your video looks better if you choose a number that is exactly divisible by the frames per second (fps) of your source. For example, if your source is captured at 30 fps, choose a frame rate of 10 or 15. Don't choose a rate greater than that of your source material.

Key Frame Specifies that key frames are generated automatically or specifies how frequently key frames are created in the exported video. A higher key frame rate (lower number) improves video quality, but increases the file size.

- 4 (MP4 file format only) Click the Video Options button and specify the following:

Re-sync Markers (MPEG-4 Basic and MPEG-4 Improved only) Uses re-sync markers in the video bit-stream. This can help regain synchronization due to transmission errors.

Restrict Profile(s) To (H.264 only) Selects profiles for playing video files on a device that conforms to one or more of the standard's profiles.

Encoding Mode (H.264 only) Specifies whether you want the best quality or faster encoding.

Specify QuickTime Movie settings (Photoshop Extended)

- 1 In the Render Video dialog box, select QuickTime Export and then choose QuickTime Movie from the pop-up menu.
- 2 Click the Settings button.
- 3 In the Movie Settings dialog box, make sure Video is selected.

Important: Although the Movie Settings dialog box displays Sound options, you cannot adjust the current audio settings. To include audio in exported files, see “[Preview audio for video layers \(Photoshop Extended\)](#)” on page 561.

- 4 Under Video, click the appropriate button to set the following:

Settings Opens the Standard Video Compression Settings dialog box so you can set the video compression and accompanying options.

Filter Opens the Choose Video Filter dialog box, where you can apply built-in QuickTime video effects.

Size Opens the Export Size Settings dialog box to specify pixel dimensions for your exported video.

- 5 (Optional) If your movie is being delivered over the Internet, select Prepare For Internet Streaming and choose any of the following:

Fast Start Sets up the movie to start playing from a web server before the movie has completely downloaded to a user’s computer hard drive.

Fast Start-Compressed Header Compresses the movie’s header losslessly and sets up the movie to start playing from a web server before the movie has completely downloaded to a user’s computer hard drive.

Hinted Streaming Sets up the movie to be streamed by a QuickTime Streaming Server.

QuickTime standard video compression settings

The following options are available in the Standard Video Compression Settings dialog box:

Compression Type Choose the codec to apply when exporting a file.

Motion Specify the frame rate for your video by choosing the number of frames per second (fps). Some codecs support a specific set of frame rates. Increasing the frame rate may produce smoother motion (depending on the original frame rates of the source clips) but uses more disk space. If available, specify how often the key frames are generated. (See “[Understanding QuickTime key frames](#)” on page 565.)

Data Rate Select (if available for the selected compressor) and type a data rate to place an upper limit on the amount of video data produced by the exported video when it is played back.

Compressor Set compressor options specific to the selected codec. Click the Option button (if available) to specify further compressor options. If the Depth menu is available, choose the number of colors to include in exported video. (This menu is not available if the selected codec supports only one color depth.)

If the Quality slider is available under Compressor, drag the slider or type a value to adjust the exported video’s picture quality and, consequently, its file size. If you are using the same codec to capture and export, and you’ve rendered previews of a sequence, you can save rendering time by matching the export quality setting with your original capture quality setting. Increasing quality above the original capture quality does not increase quality, but may result in longer rendering times.

Note: Compressor options are not available for the Component Video codec.

QuickTime movie size settings

The following settings are available in the Export Size Settings dialog box:

Dimensions Specifies the frame size for your exported movie. If you want to specify a frame size not included in the Dimensions menu, choose Custom and enter values for Width and Height.

Preserve Aspect Ratio Using Specifies an option if the movie is scaled to a new frame size. Letterbox scales the source proportionally to fit into the clean aperture, adding black bars to the top and bottom or sides as necessary. Crop centers, scales, and trims to the clean aperture. Fit Within Dimensions adjusts to the destination size by fitting to the longest side, scaling if necessary.

Deinterlace Source Video Deinterlaces the two fields in each interlaced video frame.

Chapter 19: 3D and technical imaging

Adobe Photoshop CS4 Extended supports a variety of 3D file formats. You can manipulate and merge existing 3D objects, create new 3D objects, edit and create 3D textures, and combine 3D objects with 2D images.

Adobe Photoshop CS4 Extended also offers powerful tools for technical image analysis and editing, including MATLAB integration, support for DICOM medical imaging formats, and image stack technology for sophisticated image enhancement. Measurement tools let you precisely measure complex image content and record and export measurement data.

3D overview (Photoshop Extended)

3D basics (Photoshop Extended)

Photoshop lets you open and work with 3D files created by programs like Adobe® Acrobat® 3D Version 8, 3D Studio Max, Alias, Maya, and Google Earth. Photoshop supports the following 3D file formats: U3D, 3DS, OBJ, KMZ, and DAE.

3D files can contain one or more of the following components:

Meshes Provide the underlying structure of a 3D model. A mesh is often visualized as a wireframe, a skeletal structure built from thousands of individual polygons. A 3D model always has at least one mesh, and may combine multiple meshes. In Photoshop you can view meshes in a variety of render modes, and manipulate meshes independently of each other. While you can't alter the actual polygons in a mesh, you can change its orientation and transform it by scaling along different axes. You can also create your own 3D meshes, using pre-supplied shapes or by converting existing 2D layers.

Materials A mesh can have one or more materials associated with it, which control the appearance of all or part of the mesh. The material in turn relies on subcomponents called texture maps, whose cumulative effect creates the appearance of a material. The texture map itself is a 2D image file that creates various qualities such as color, pattern, shininess, or bumpiness. A Photoshop material can use up to nine different texture map types to define its overall appearance. See “[3D Materials settings \(Photoshop Extended\)](#)” on page 579.

Lights Types include Infinite, Spot, and Point. You can move and adjust color and intensity of existing lights, and add new lights to your 3D scene.

3D files opened in Photoshop retain their textures, rendering, and lighting information. You can move or animate 3D models, change render modes, edit or add lights, or combined multiple 3D models into one 3D scene.

Textures appear as entries under a 3D layer in the Layers panel. You can open and edit textures separately as 2D files, or edit textures directly on the model, using Photoshop painting and adjustment tools.

You can also create 3D content from scratch within Photoshop, using a 2D layer as a starting point:

- Wrap 2D layers around a variety of shape presets, such as cubes, spheres, cylinders, cones, or pyramids.
- Create 3D postcards (planes which you can position and light in 3D space).
- Create 3D meshes from grayscale or text layers.

You can add multiple 3D layers to an image, combine a 3D layer with two-dimensional (2D) layers to create a backdrop for your 3D content, or convert a 3D layer into a 2D layer or a Smart Object.

Note: To edit the polygon mesh of the 3D model itself, you must use a 3D authoring program.

For a video on working with 3D files in Photoshop, see www.adobe.com/go/lrvid4004_ps.

About OpenGL

OpenGL is a software and hardware standard that accelerates video processing when working with large or complex images, such as 3D files. OpenGL requires a video adapter that supports the OpenGL standard. Your performance when opening, moving, and editing 3D models is significantly improved on a system with OpenGL installed.

Note: If OpenGL is not detected on your system, Photoshop uses software-only ray-trace rendering to display 3D files.

If OpenGL is present on your system, you can enable it in Photoshop Preferences.

1 Do one of the following:

- (Windows) Choose Edit > Preferences > Performance.
- (Mac OS) Choose Photoshop > Preferences > Performance.

2 In the GPU pane, select Enable OpenGL Drawing.

3 Click OK. The preference affects new (not currently open) windows. No restart is necessary.

Note: Enable OpenGL Drawing must be selected to display the 3D Axis, Ground Plane, and Lights widget.

Open a 3D file

You can open a 3D file on its own or add it to an open Photoshop file as a 3D layer. When adding a file as a 3D layer, the layer uses the dimensions of the existing file. A 3D layer contains the 3D model and a transparent background.

Photoshop can open the following 3D formats: U3D, 3DS, OBJ, DAE (Collada), and KMZ (Google Earth).

❖ Do one of the following:

- Choose File > Open, and select a 3D file to open.
- With a document open, choose 3D > New Layer From 3D File, then select a 3D file to open. This adds an existing 3D file as a layer to your current file.

Note: A 3D layer does not preserve any background or alpha information from the original 3D file.

If you add a 3D file layer to an existing file, it appears above the currently selected layer and becomes the active layer.

- Textures that are part of the 3D file appear in the Layers panel under the new 3D layer. See “[Create and edit textures for 3D models \(Photoshop Extended\)](#)” on page 584.
- If your system supports OpenGL and the Enable OpenGL Drawing preference is enabled, the 3D Axis appears when you select a 3D layer and a 3D tool. See “[Using the 3D Axis \(Photoshop Extended\)](#)” on page 574.
- The 3D object and camera tools are active when a 3D layer is selected. See “[Using the 3D tools \(Photoshop Extended\)](#)” on page 572.
- The components of the 3D file (meshes, materials, and lights) are listed in the 3D panel. See “[3D panel overview \(Photoshop Extended\)](#)” on page 575.

Using the 3D tools (Photoshop Extended)

The 3D tools become active when a 3D layer is selected. Use the 3D object tools to change the position or scale of a 3D model; use the 3D camera tools to change the view of the scene. If your system supports OpenGL, you can also use the 3D Axis to manipulate the 3D model. See “[Using the 3D Axis \(Photoshop Extended\)](#)” on page 574.

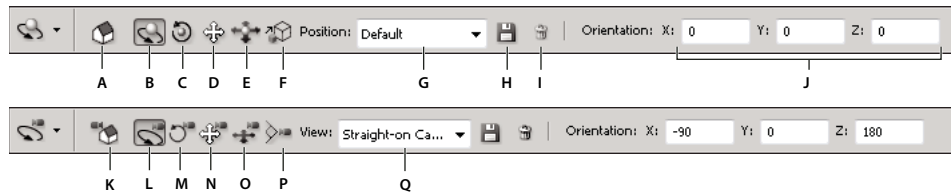

Options for 3D object tools (above) and 3D camera tools (below)

A. Return to initial object position B. Rotate C. Roll D. Drag E. Slide F. Scale G. Position menu H. Save current position/camera view I. Delete current position/camera view J. Position/camera view coordinates K. Return to initial camera position L. Orbit M. Roll N. Pan O. Walk P. Zoom Q. View menu

For a video on using the 3D tools, see www.adobe.com/go/lrvid4005_ps.

Move, rotate, or scale a model with 3D object tools

You can use the 3D object tools to rotate, reposition, or scale a model. While you manipulate the 3D model, the camera view remains fixed.

For tips about each 3D tool, choose Panel Options from the Info panel menu , and select Show Tool Hints. Click a tool, then move the cursor into the image window to view tool details in the Info Panel.

❖ In the Tools panel, click a 3D object tool, and hold down the mouse button to select from the following types:

Hold down Shift as you drag to constrain the Rotate, Drag, Slide, or Scale tool to a single direction of movement.

Rotate Drag up or down to rotate the model around its x-axis, or side to side to rotate it around its y axis. Hold down Alt (Windows) or Option (Mac OS) as you drag to roll the model.

Roll Drag side to side to rotate the model around its z axis.

Drag Drag side to side to move the model horizontally, or up or down to move it vertically. Hold down Alt (Windows) or Option (Mac OS) as you drag to move in the x/z direction.

Slide Drag side to side to move the model horizontally, or up or down to move it closer or farther away. Hold down Alt (Windows) or Option (Mac OS) as you drag to move in the x/y direction.

Scale Drag up or down to scale the model larger or smaller. Hold down Alt (Windows) or Option (Mac OS) as you drag to scale in the z direction.

Click the Return To Initial Position icon in the options bar to return the model to its initial view.

To numerically adjust position, rotation, or scaling, enter values on the right side of the options bar.

Move the 3D camera

Use the 3D camera tools to move the camera view while leaving the position of the 3D object fixed.

For tips about each 3D tool, choose Panel Options from the Info panel menu , and select Show Tool Hints. Click a tool, then move the cursor into the image window to view tool details in the Info Panel.

❖ In the Tools panel, click a 3D camera tool, and hold down the mouse button to select from the following types:

Hold down Shift as you drag to constrain the Orbit, Pan, or Walk tools to a single direction of movement.

Orbit Drag to orbit the camera in the x or y direction. Hold down Ctrl (Windows) or Option (Mac OS) as you drag to roll the camera.

Roll Drag to roll the camera.

Pan Drag to pan the camera in the x or y direction. Hold down Ctrl (Windows) or Option (Mac OS) as you drag to pan in the x or z direction.

Walk Drag to walk the camera (z translation and y rotation). Hold down Ctrl (Windows) or Option (Mac OS) as you drag to walk in the z/x direction (z translation and x rotation).

Zoom Drag to change the field of view of the 3D camera. Maximum field of view is 180.

Perspective Camera (Zoom only) Displays parallel lines converging to vanishing points.

Orthographic Camera (Zoom only) Maintains parallel lines without convergence. Displays the model in accurate scale view without any perspective distortion.

In the options bar, numeric values show the x, y, and z position of the 3D camera. You can also edit these values manually to adjust the camera view.

Change or create 3D camera views

❖ Do one of the following:

- Select a preset camera view of the model from the View menu.

Note: All preset camera views use orthographic projection.

- To add a custom view, place the 3D camera in the desired position using the 3D camera tools, then click Save in the options bar.

💡 To return to the default camera view, select a 3D camera tool, and click the Return To Initial Camera Position icon  in the options bar.

Using the 3D Axis (Photoshop Extended)

The 3D Axis shows the current X, Y, and Z-axis orientation of the 3D model in 3D space. It appears when you have a 3D layer and 3D tool selected. You can use the 3D Axis as an alternative to the 3D position tools to move, rotate, or resize a 3D model in object space. (To change scene view, use the 3D camera tools.)

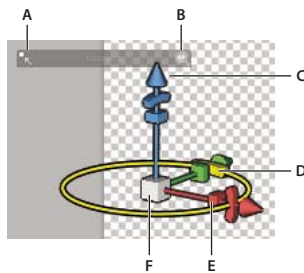

3D Axis with rotation control selected.

A. Minimize 3D Axis B. Resize 3D Axis C. Move 3D object along an axis D. Rotate 3D object E. Compress/elongate 3D object F. Resize 3D object

Note: OpenGL must be enabled to display the 3D Axis. See “About OpenGL” on page 572.

For a video on using the 3D Axis, see www.adobe.com/go/lrvid4005_ps.

Move, rotate, or scale a model with the 3D Axis

To use the 3D Axis, move the mouse pointer over an axis component to highlight it, and then drag.

- To move the model along the X, Y, or Z-axis, highlight the conical tip of any axis. Drag in either direction along the axis.

- To rotate the model, click the curved rotation segment just inside an axis tip. A yellow circle appears showing the rotation plane. Drag in a clockwise or counterclockwise circle around the 3D Axis center. To rotate more gradually, move the mouse further away from the center of the 3D Axis.
- To resize the model, drag the center cube in the 3D Axis up or down.
- To compress or elongate the model along an axis, drag one of the colored transform cubes either toward or away from the center cube.
- To constrain movement to an object plane, move the mouse pointer into the area where two axes intersect, near the center cube. A yellow plane icon appears between two axes. Drag in any direction. You can also move the pointer over the lower part of the center cube to activate the plane icon.

Minimize, restore, move, or resize the 3D Axis

- 1 Move the pointer over the 3D Axis to display the control bar.
- 2 Do one of the following:
 - To move the 3D Axis, drag the control bar.
 - To minimize, click the minimize icon.
 - To restore to normal size, click the minimized 3D Axis.
 - To resize, drag the zoom icon.

Show or hide the 3D Axis

- Choose View > Show > 3D Axis.

3D panel overview (Photoshop Extended)

When you select a 3D layer, the 3D panel shows the components of the associated 3D file. The top section of the panel lists the meshes, materials, and lights in the file. The bottom section of the panel shows settings and options for the 3D component selected in the top section.

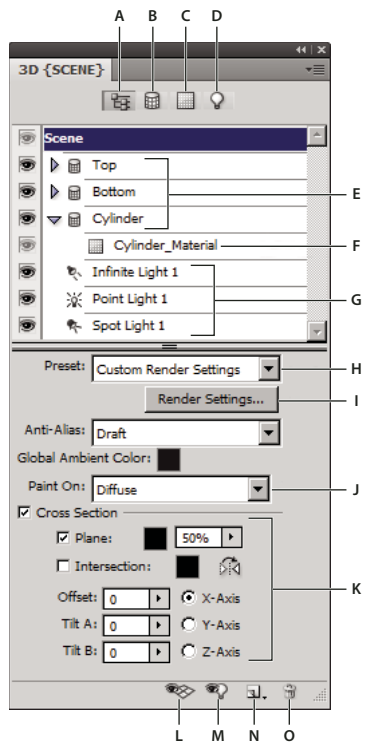

3D panel with Scene tab selected.

A. Scene button B. Meshes button C. Materials button D. Lights button E. Meshes F. Material G. Lights H. Render presets menu I. Customize render settings J. Select texture to paint on K. Cross section settings L. Toggle ground plane M. Toggle lights N. Add new light O. Delete light

You can use the buttons at the top of the 3D panel to filter the components that appear in the top section. Click the Scene button to show all components, click Materials to see just materials, and so forth.

The buttons at the bottom of the 3D panel are enabled depending on the selected 3D component. The Toggle Ground Plane and Toggle Lights buttons are always available.

Note: Toggle Ground Plane and Toggle lights buttons are only enabled if OpenGL is enabled on your system. See “About OpenGL” on page 572.

For a video on using the 3D panel, see www.adobe.com/go/lrvid4004_ps.

Display the 3D panel

- ❖ Do one of the following:
 - Choose Window > 3D.
 - Double-click the 3D layer icon  in the Layers panel.
 - Choose Window > Workspace > Advanced 3D.

Filter the 3D options displayed

- ❖ Click the Scene, Mesh, Materials, or Lights button at the top of the 3D panel.

Show or hide a 3D mesh or light

- ❖ Click the eye icon next to the mesh or light entry in the top section of the 3D panel.

Note: You cannot turn material display on or off from the 3D panel. To show or hide materials, change the visibility settings for their associated textures in the Layers panel. See “3D Materials settings (Photoshop Extended)” on page 579.

Access settings for the 3D scene

- 1 Click the Scene button.
- 2 If not already selected, click the Scene entry at the top of the component list.

Access settings for a mesh, material, or light

- ❖ Do one of the following:
 - Click the Scene button to show all scene components. Then select a mesh, material, or light in the top section.
 - Click the Meshes, Materials, or Lights button to temporarily display just those components. Then select a single mesh, material, or light.

Expand or collapse materials for a mesh

- 1 Click the Scene button.
- 2 Click the triangle to the left of a mesh icon.

View the ground plane

The ground plane is a grid that reflects the position of the ground relative to the 3D model.

- ❖ Do one of the following:
 - From the 3D panel menu ▾☰, select Ground Plane.
 - Click the Toggle Ground Plane button at the bottom of the 3D panel.

Show or hide light guides

- ❖ Do one of the following:
 - From the 3D panel menu ▾☰, select Light Guides.
 - Click the Toggle Lights button at the bottom of the 3D panel.

3D Scene settings (Photoshop Extended)

Use 3D Scene settings to change render modes, select a texture to paint on, or create cross sections. To access scene settings, click the Scene button  in the 3D panel, then select the Scene entry in the top section of the panel.

Preset Specifies the render preset for the model. To customize options, click Render Settings. For more information, see “Change render settings for 3D models (Photoshop Extended)” on page 593.

Anti-Alias Choose a setting which provides the best display quality while maintaining good performance. Display quality is highest with the Best setting; performance is best with the Draft setting.

Global Ambient Color Sets the color for global ambient light visible on reflective surfaces. This color interacts with the ambient color for specific materials. See “3D Materials settings (Photoshop Extended)” on page 579.

Paint On When painting directly on the 3D model, use this menu to choose which texture map to paint on. See “Paint on 3D models (Photoshop Extended)” on page 587.



You can also choose the target texture for painting by choosing 3D > 3D Paint mode.

Cross Section Select to create a planar cross section that can intersect the model at an angle you choose. Allows you to slice through a model and view interior content. See “[View cross sections](#)” on page 578.

View cross sections

You can view a cross section of a 3D model by intersecting it with an invisible plane that slices through the model at any angle and displays content only on one side of the plane.

- 1 Select Cross Section in the bottom section of the Scenes tab.
- 2 Choose options for alignment, position, and orientation:

Plane Select to display the intersecting plane that creates the cross section. You can choose plane color and opacity.

Intersection Select to highlight the areas of the model that the cross section plane intersects. Click the color swatch to select the highlight color.

Flip Cross Section Changes the displayed area of the model to the opposite side of the intersecting plane.

Offset and Tilt Use Offset to shift the plane along its axis, without changing its tilt. At a default offset of 0, the plane intersects the 3D model at its midpoint. At maximum positive or negative offsets, the plane moves beyond any intersection with the model. Use Tilt settings to rotate the plane up to 360° in either of its possible tilt directions. For a particular axis, the tilt settings rotate the plane along the other two axes. For example, a plane aligned to the y-axis can be rotated around the x-axis (Tilt 1) or the z-axis (Tilt 2).

Alignment Select an axis (x, y, or z) for the intersecting plane. The plane is perpendicular to the selected axis.

Apply different render modes to each cross section

You can vary the render settings for each side of a cross section to combine different views of the same 3D model, such as Wireframe with Solid.

- 1 Select Cross Section, and choose options in the bottom section of the Scenes tab. Your current render settings are applied to the visible cross section.
- 2 Click Render Settings, or choose 3D > Render Settings.
- 3 At the top of the dialog box, click the currently unselected Cross Section button .
- By default all render settings are turned off for the alternate cross section, making it appear invisible.
- 4 Choose render options for the alternate cross section, and click OK.

3D Mesh settings (Photoshop Extended)

Each mesh in the 3D model appears on a separate line in the top section of the 3D panel. Select a mesh to access mesh settings and information in the lower section of the 3D panel.

Information includes the number of materials and textures applied to the mesh, as well as the number of vertices and faces it contains. You can also set mesh display options:

Catch Shadows In Ray Traced render mode, controls whether the selected mesh displays shadows on its surface from other meshes.

Cast Shadows In Ray Traced render mode, controls whether the selected mesh casts shadows on other mesh surfaces.

Note: Lights must be set to create shadows.

Invisible Hides the mesh, but displays any shadows on its surface.

Show or hide a mesh

- ❖ Click the eye icon next to a mesh name in the top section of the 3D panel.

Manipulate individual meshes

Use the mesh position tools to move, rotate, or scale a selected mesh without moving the model as a whole. The position tools operate in the same way as the main 3D position tools in the Tools panel. For information on each tool, see “[Move, rotate, or scale a model with 3D object tools](#)” on page 573.

- 1 Select a mesh in the top section of the 3D panel. The selected mesh is highlighted with a red box in the lower section of the panel.
- 2 Select and use a mesh position tool in the lower section of the panel to move the mesh.

 *To manipulate the entire model while an individual mesh is selected, use the 3D tools in the Tools panel.*

3D Materials settings (Photoshop Extended)

The top part of the 3D panel lists the materials used in the 3D file. One or multiple materials may be used to create the overall appearance of the model. If a model contains several meshes, there may be a specific material associated with each mesh. Or a model can be built from one mesh, but use several materials. In this case each material controls the appearance of a particular part of the mesh.

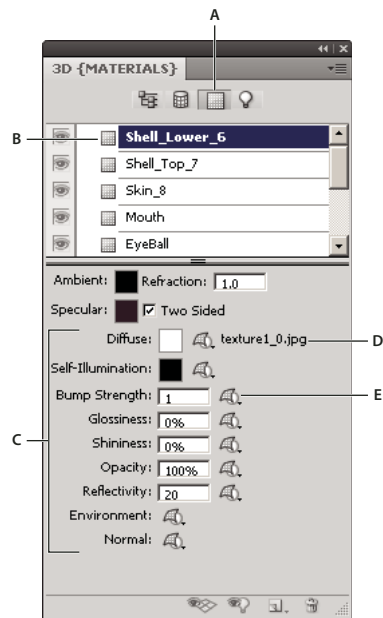

A selected material and its associated texture maps.

A. Materials button B. Selected material C. Texture map types D. Texture map filename E. Texture map menu icon

For a selected material in the top section of the 3D panel, the lower section shows the particular texture maps used by that material. Some texture maps, such as Diffuse and Bump, commonly rely on 2D files to supply a particular color or pattern that creates the texture. If a material is using a texture map, the texture file is listed next to the map type.

 *The 2D texture maps used by a material also appear as Textures in the Layers panel, grouped by the texture map category. More than one material can use the same texture map.*

You can create, load, open, remove, or edit the properties of texture maps using the texture map menu  next to each texture type. You can also create a texture by painting directly on an area of the model. See “Paint on 3D models (Photoshop Extended)” on page 587.

Note: Depending on the texture type, you may not need or want a separate 2D file to create or modify a material’s appearance. For example, you can adjust the Glossiness, Shininess, Opacity, or Reflectivity of a material by entering a value or using the scrubby slider controls next to those texture types.

Ambient Sets the color for ambient light visible on reflective surfaces. This color interacts with the Global Ambient Color for the entire scene. See “3D Scene settings (Photoshop Extended)” on page 577.

Refraction Sets the refractive index, when Face Style rendering is set to Ray Traced, and the Refractions option is selected (3D > Render Settings, Face Rendering section). Refraction is the change in light direction that occurs at the intersection of two media (such as air and water) with different refractive indexes. The default value for new materials is 1.0 (the approximate value for air).

Specular The color displayed for specular properties (for example, highlight glossiness and shininess).

Diffuse The color of the material. The diffuse map can be a solid color or any 2D content. The Diffuse color swatch value sets the diffuse color if you choose to remove the diffuse texture map. You can also create a diffuse map by painting directly on the model. See “Paint on 3D models (Photoshop Extended)” on page 587.

Self-illumination Defines a color that doesn’t rely on lighting to display. Creates the effect that the 3D object is lit from within.

Bump Strength Creates bumps in the material surface, without altering the underlying mesh. A bump map is a grayscale image in which lighter values create raised surface areas and darker values create flatter surface areas. You can create or load a bump map file, or begin painting on the model to automatically create a bump map file. See “Paint on 3D models (Photoshop Extended)” on page 587.

The Bump Strength field increases or reduces bumpiness. It is only active if a bump map exists. Enter a number in the field or use the scrubby slider to increase or decrease bump strength.

 *Bumpiness is most pronounced when a surface is viewed head on, rather than at an angle.*

Glossiness Defines the amount of light from a source that reflects off the surface and back to the viewer. You can adjust glossiness by entering a value in the field or using the scrubby slider. If you create a separate glossiness map, the intensity of colors in the map controls glossiness in the material. Black areas create full glossiness, white areas remove all glossiness, and middle values reduce the size of a highlight.

Shininess Defines the dispersion of the reflected light generated by the Glossiness setting. Low shininess (high dispersion) produces more apparent light, with less focus. High shininess (low dispersion) produces less apparent light and brighter, crisper highlights.

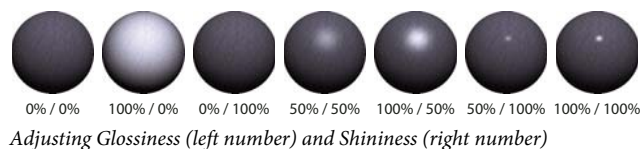

Opacity Increases or decreases opacity of the material (0-100%). You can use a texture map or the scrubby slider to control opacity. The grayscale values of the texture map control the opacity of the material. White values create complete opacity and black values create complete transparency.

Reflectivity Increases the reflection of other objects in the 3D scene, and the environment map, on the material surface.

Environment Stores the image of the environment surrounding the 3D model. Environment maps are applied as spherical panoramas. The contents of the environment map can be seen in the reflective areas of the model.

 *To prevent an environment map from reflecting on a given material, change Reflectivity to 0%, add a reflectivity map that masks the material area, or remove the environment map for that material.*

Normal Like a bump map texture, a normal map increases surface detail. Unlike a bump texture map, which is based on a single-channel grayscale image, a normal map is based on a multi-channel (RGB) image. The values of each color channel represent the x, y, and z components of a normal on the model surface. A normal map can be used to smooth the surfaces of low polygon meshes.

Note: *If a 3D object has more than the nine texture types Photoshop supports, additional textures appear in the Layers panel and the 3D Paint Mode list. (To display the latter, choose 3D > 3D Paint Mode, or use the Paint On menu in the Scene section of the 3D panel).*

Save or load a materials preset

Material presets store all texture map settings. Photoshop Extended stores materials presets in P3M files. A variety of these files are installed by default, letting you quickly apply popular texture types like steel, fabric, and wood.

- To save current texture map settings, choose Save Material Preset from the 3D panel menu.
- To load a saved preset, choose Replace Material from the 3D panel menu.

Create a texture map

- 1 Click the texture map menu icon  next to the texture map type you want to create.
- 2 Choose New Texture.
- 3 Enter the name, dimensions, resolution, and color mode for the new map, then click OK.

 *To match the aspect ratio of an existing texture map, view its dimensions by hovering the mouse pointer over the map name in the Layers panel.*

The name of the new texture map is displayed next to the texture map type in the Materials panel. It is also added to the texture list under the 3D layer in the Layers panel. The default name is the texture map type appended to the material name.

Create a bump texture map

A bump texture map filled with a neutral grayscale value provides more range when painting on the map.

- 1 In the Tools panel, click the Set Background Color swatch.
- 2 In the Color Picker, set brightness to 50%, and set R, G, and B values to equal values. Click OK.
- 3 In the 3D panel, click the texture map menu icon  next to Bump Strength.
- 4 Choose New Texture.
- 5 Choose the following settings in the New dialog box:
 - For Color Mode, choose Grayscale
 - For Background Contents, choose Background Color.
 - (Optional) Set Width and Height to match the dimensions of the diffuse texture map for the material.
- 6 Click OK.

The bump texture map is created and added to the texture map files listed in the Materials panel. It also appears as a texture in the Layers panel.

Open a texture map for editing

- ❖ Click the texture map menu icon  and choose Open Texture.

The texture map opens as a Smart Object in its own document window. After editing the texture, make the 3D model document window active to see updates to the model. See “[Create and edit textures for 3D models \(Photoshop Extended\)](#)” on page 584.

Load a texture map

You can load an existing 2D texture file for any of the nine available texture map types.

- 1 Click the texture map menu icon  next to the texture type.
- 2 Choose Load Texture, then select and open the 2D texture file.

Delete a texture map

- 1 Click the texture map menu icon  next to the texture type.
- 2 Choose Remove Texture.

 *If the deleted texture is an external file, you can reload it using the Load Texture command from the texture map menu. For textures that are internally referenced by the 3D file, choose Undo or Step Backward to restore a deleted texture.*

Edit texture properties

A texture map is applied to a particular surface area of the model, depending on its UV mapping parameters. You can adjust UV scale and offset if necessary to improve how the texture maps to the model.

- 1 Click the texture map menu icon  next to the texture type.
- 2 Choose Edit Properties.
- 3 Choose a target layer and set UV Scale and Offset values. You can enter values directly or use the scrubby sliders.

Note: Change the UV Scale and Offset settings only if a model has incorrect UV mapping.

Target Determines whether settings apply to a specific layer or the composite image.

U and V Scale Resize mapped textures. To create a repeating pattern, decrease the value.

U and V Offset Reposition mapped textures.

See also

“[Create UV overlays](#)” on page 586

3D Lights settings (Photoshop Extended)



3D lights illuminate models from different angles, adding realistic depth and shadows. Photoshop Extended provides three types of lights, each with unique options:

- Point lights shine in all directions, like light bulbs.
- Spot lights shine in a cone shape, which you can adjust.
- Infinite lights shine from one directional plane, like sunlight.

To position any of these lights, you use tools similar to those used for 3D models themselves.

 For a video about adjusting 3D lights, see www.adobe.com/go/lrvid4004_ps. (Light-related discussion begins at the five-minute mark.)

Add or delete individual lights







- ❖ In the 3D panel, do either of the following:
 - To add a light, click the Create A New Light button , and choose the light type (point, spot, or infinite).
 - To delete a light, select it from the list at the top of the Lights section . Then click the Delete button  at the bottom of the panel.

Adjust light properties

- 1 In the Lights section  of the 3D panel, select a light from the list.
- 2 (Optional) To change the light type, select a different option from the first pop-up menu in the lower half of the panel.
- 3 Set the following options:
 - Intensity** Adjusts brightness.
 - Color** Defines the color of the light. Click the box to access the Color Picker.
 - Create Shadows** Casts shadows from foreground surfaces onto background surfaces, from a single mesh onto itself or from one mesh onto another. Disabling this option improves performance slightly.
 - Softness** Blurs the edge of shadows, producing a gradual falloff.
- 4 For point or spot lights, set the following options:
 - Hotspot** (Spot lights only) Sets the width of the bright center of the light.
 - Falloff** (Spot lights only) Sets the outer width of the light.
 - Use Attenuation** Inner and Outer options determine the cone of attenuation and how fast light intensity decreases as distance from objects increases. When an object is closer than Inner limit, light is full strength. When an object is further than Outer limit, light is at zero strength. At intermediate distances, light attenuates linearly from full strength to zero.

 Hover the pointer over the Hotspot, Falloff, and Inner and Outer attenuation options. Red outlines in the icon to the right indicate the affected light element.

Position lights

- ❖ In the Lights section  of the 3D panel, select any of the following:
 - Rotate tool**  (Spot and infinite lights only) Rotates light while maintaining its position in 3D space.
 - Drag tool**  (Spot and point lights only) Moves the light to a different position in the same 3D plane.
 - Slide tool**  (Spot and point lights only) Moves the light to a different 3D plane.
 - Point Light at Origin**  (Spot light only) Directs light at the center of the model.
 - Move to Current View**  Places light in the same position as the camera.

Add light guides

Light guides provide spatial reference points for your adjustments. These guides reflect the type, angle, and attenuation of each light. Point lights appear as a ball, spot lights as a cone, and infinite lights as a line.

- ❖ At the bottom of the 3D panel, click the Toggle Lights icon .

 You can change the guide color in the Guides, Grids, and Slices section of the Preferences dialog box.

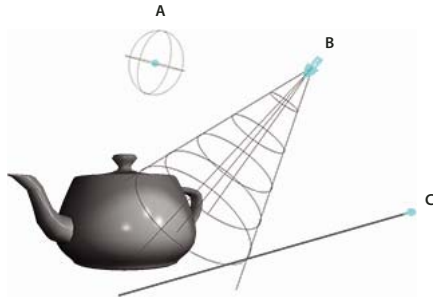

Light Guides:
A. Point light **B.** Spot light **C.** Infinite light

Save, replace, or add groups of lights

To store groups of lights for later use, save them. To include the lights in other projects, either add to or replace the existing set.

❖ From the 3D panel menu , select any of the following:

Save Lights Preset Saves the current group of lights as a preset that you can reload with the following commands.

Add Lights To the existing lights, adds a lights preset that you select.

Replace Lights Replaces the existing lights with a preset that you select.

3D editing and output (Photoshop Extended)

Create and edit textures for 3D models (Photoshop Extended)

You can use the Photoshop painting and adjustment tools to edit the textures contained in a 3D file, or to create new textures. Textures are imported as 2D files with the 3D model. They appear as entries in the Layers panel, nested under the 3D layer, and grouped by map type: Diffuse, Bump, Glossiness, and so on.

 To view a thumbnail of a particular texture file, hover the mouse pointer over the name of the texture in the Layers panel. The image size and color mode are also displayed.

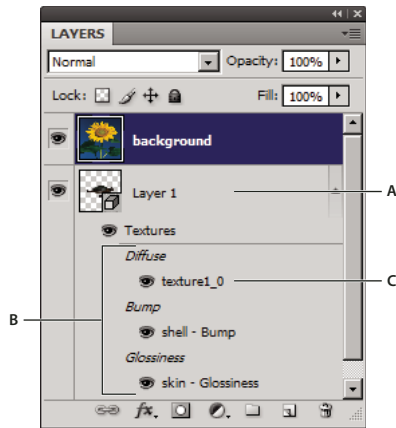

Layers panel showing 3D textures, grouped by texture map type
A. 3D layer B. Texture map types C. Texture map filename

Note: Texture maps used by a particular material also appear in the lower section of the 3D panel when a material is selected. See “3D Materials settings (Photoshop Extended)” on page 579.

To edit 3D textures in Photoshop, do either of the following:

- Open the texture as a 2D file for editing in its own document window. Textures open as Smart Objects.
- Edit a texture directly on the model. If necessary you can temporarily cut away model surfaces to access areas to paint on. See “Paint on 3D models (Photoshop Extended)” on page 587.

See also

“Paint with the Brush tool or Pencil tool” on page 329

Edit a texture in 2D format

1 Do one of the following:

- Double-click the texture in the Layers panel.
- In the Materials panel, select the material that contains the texture. In the bottom section of the panel, click the texture menu icon  for the texture you want to edit, and choose Open Texture.

The texture opens as a Smart Object in a separate document window.

- 2 Use any Photoshop tool to paint on or edit the texture.
- 3 Make the window containing the 3D model active to see the updated texture applied to the model.
- 4 Close the Smart Object window and save changes to the texture.

Display or hide a texture

You can display and hide a texture to help identify what area of the model the texture is applied to.

- ❖ Click the eye icon next to the Texture layer. To hide or display all textures, click the eye icon next to the top-level Texture layer.

Create UV overlays

A diffuse texture file used by multiple materials on a 3D model can group several content areas that are applied to different surfaces on the model. The process called *UV mapping* matches coordinates in the 2D texture map with specific coordinates on the 3D model. UV mapping allows the 2D texture to be painted correctly onto the 3D model.

For 3D content created outside Photoshop, UV mapping occurs in the program where the content was created. However, Photoshop can create UV overlays as guides to help you visualize how a 2D texture map matches up with the 3D model surfaces. These overlays act as guides when editing a texture.

- 1 Double-click a texture in the Layers panel to open it for editing.

Note: Create UV Overlays is only enabled when a texture map is open and is the active window.

- 2 Choose 3D > Create UV Overlays, then select an overlay option.

Wireframe Shows edge data of the UV mapping.

Shaded Shows model areas using a solid rendering mode.

Normal Map Shows geometric normals translated to RGB values, where R=X, G=Y, and B=Z.

UV overlays are added as additional layers in the Layers panel for the texture file. You can show, hide, move, or delete a UV overlay. The overlays appear on the model surface when you close and save the texture file, or switch from the texture file to the associated 3D layer (the texture file is auto saved).

Note: Delete or hide UV overlays before performing a final render.

Reparameterize a texture map

Occasionally you may open a 3D model whose textures are poorly mapped to the underlying model mesh. Poor texture mapping can produce obvious distortions in the surface appearance of the model, such as unwanted seams or areas of stretching or squeezing of the texture pattern. Poor texture mapping can also cause unpredictable results when you paint directly on the model.

 *To check texture parameterization, open a texture for editing, then apply a UV Overlay to see how the texture aligns with the model surfaces. See “Create UV overlays” on page 586.*

The Reparameterization command remaps a texture to the model to correct distortion and create more effective surface coverage.

- 1 Open a 3D file with a poorly mapped diffuse texture, and select the 3D layer containing the model.
- 2 Choose 3D > Reparameterize. Photoshop notifies you that you are reapplying the texture to the model. Click OK.
- 3 Choose a reparameterization option:
 - Low Distortion keeps the texture pattern more intact, but can create more seams on the model surface.
 - Fewer Seams minimizes the number of seams that appear on the model. This can produce more stretching or pinching of the texture, depending on the model.



Reparameterized texture using Low Distortion (left) and Fewer Seams (right)



- 4 (Optional) If the reparameterization option you chose does not create optimal surface coverage, choose Edit > Undo and try the other option.

You can also use the Reparameterize command to improve the default texture mapping that occurs when you create 3D models from 2D layers. See “[Create 3D objects from 2D images \(Photoshop Extended\)](#)” on page 590.

Create a tile for a repeating texture

A repeating texture is composed of identical tiles in a grid pattern. A repeating texture can provide more realistic surface coverage of the model, use less storage, and improve rendering performance. You can convert any 2D file into a tiled painting. After previewing how multiple tiles interact in the painting, you save one tile for use as a repeating texture.

 *To set up a mesh for a repeating texture, use the 3D application that created the model.*

- 1 Open a 2D file.
- 2 Select one or more layers in the file, then choose 3D > New Tiled Painting.
The 2D file is converted to a 3D plane containing nine identical tiles of the original content. Image dimensions remain the same.
- 3 Edit the tiled texture with painting tools, filters, or other techniques. (Changes you make to one tile automatically appear in the others.)
- 4 Save a single tile as a 2D image: In the Materials section  of the 3D panel, choose Open Texture from the Diffuse menu . Then choose File > Save As, and specify a name, location, and format.

 *Unless you plan to use the original, nine-tile painting independently, close it without saving.*

- 5 To load the tile as a repeating texture, open a 3D model file. In the Materials section of the 3D panel, choose Load Texture from the Diffuse menu, and select the file you saved above.

Paint on 3D models (Photoshop Extended)

You can use any Photoshop painting tools to paint directly on a 3D model just as you would on a 2D layer. Use selection tools to target specific model areas or let Photoshop identify and highlight paintable areas. 3D menu commands let you clear away areas of a model to access interior or hidden portions for painting.

When painting directly on the model, you can choose which underlying texture map to apply paint to. Typically paint is applied to the diffuse texture map, which gives a model material its color properties. You can also paint on other texture maps, such as the bump map or opacity map. If you paint on an area of the model that lacks the type of texture map you're painting on, a texture map is automatically created.

- 1 Use the 3D position tools to orient the model so that the area you want to paint on is facing forward.

If the model area is hidden, you can temporarily cut away surface areas that are blocking your view. See “[Reveal surfaces to paint on](#)” on page 588.



If you are painting on curved or irregular surfaces, you can get visual feedback before you paint of which areas can best receive paint. See “[Identify paintable areas](#)” on page 589. You can also set the paint fall-off angle, which controls the amount of paint applied to angled surfaces. See “[Set the paint falloff angle](#)” on page 589.

- 2 Do one of the following to set the texture map to paint on:
 - Choose 3D > 3D Paint Mode, and select a map type.
 - In the 3D panel, select the Scene panel. Choose a map type from the Paint On menu.

If you try to paint on a texture map type that the material doesn't contain, Photoshop prompts you to create a map. For information on map types, see “[3D Materials settings \(Photoshop Extended\)](#)” on page 579.

- 3 (Optional) Using any selection tool, create a selection on the 3D model to restrict the area that you want to paint on.
- 4 Apply paint using the Paintbrush tool. You can also use any other tool in the second section of the Tools panel, such as the Paint Bucket, Smudge, Dodge, Burn, or Blur tools.

While painting (after completing a stroke), you can view the effect of the painting on the texture map itself. Do one of the following:

- Double-click the texture map in the Layers panel to open it.
- In the Materials section  of the 3D panel, select the material for the area you are painting. In the lower section of the panel, click the menu icon  for the texture map you're painting, and choose Open Texture.

For a video on painting on the 3D model, see www.adobe.com/go/lrvid4005_ps.

Reveal surfaces to paint on

For more complex models with interior or hidden areas, you can hide sections of the model for easier access to surfaces you want to paint. For example, to apply paint to the dashboard of a car model, you can temporarily cut away the roof or windshield, then zoom inside the car to get an unobstructed view.

- 1 Select an area of the model that you want to cut away, using a selection tool such as the Lasso or Marquee tool.
- 2 Use any of the following 3D menu commands to reveal or hide areas of the model:

Hide Nearest Surface hides only the first layer of model polygons within the 2D selection. To quickly peel away surfaces of the model, you can use this command repeatedly while keeping the selection area active.

 *When hiding surfaces, rotate the model if necessary to position surfaces so that they are perpendicular to your current view.*

Only Hide Enclosed Polygons When selected, the Hide Nearest Surface command only affects polygons that are fully within the selection. When unchecked, it hides any polygons touched by the selection.

Invert Visible Surfaces Makes currently visible surfaces invisible, and invisible surfaces visible.

Reveal All Surfaces Makes all hidden surfaces visible again.

Set the paint falloff angle

When painting on a model, the paint falloff angle controls how much paint is applied to a surface as it curves away from the forward-facing view. The falloff angle is calculated based on a “normal”, or straight line projecting out from the part of the model surface that faces you. For example, in a spherical model such as a soccer ball, the falloff angle to the exact center of the ball as it faces you is 0 degrees. As the surface of the ball curves away, the falloff angle increases, up to 90 degrees at the edges of the ball.

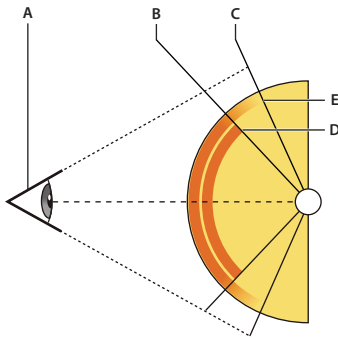

A. Eye/camera angle B. Minimum angle C. Maximum angle D. Paint fade start E. Paint fade end

1 Choose 3D > 3D Paint Falloff

2 Set the minimum and maximum angle settings.

- The maximum paint falloff range is 0 - 90 degrees. At 0 degrees, paint is only applied to the surface if it is facing directly forward, with no drop-off angle. At 90 degrees, paint can follow a curved surface such as a sphere to its visible edges. At a 45 degree setting, the painted area is limited to the areas of the sphere that don't curve away at more than 45 degrees.
- The Minimum falloff angle sets a range within which paint gradually fades as it approaches the maximum falloff angle. For example, if the maximum falloff angle is 45, and the minimum falloff is 30, paint opacity decreases from 100 to 0 percent between 30 and 45 degrees of falloff.

Identify paintable areas

It may not be clear just from looking at a 3D model whether you can successfully paint on certain areas. Because the model view may not provide a 1 to 1 correspondence with the 2D texture itself, applying paint directly to the model is different from directly painting on a 2D texture map. What appears to be a small brush on the model may in fact be much larger in relation to the texture, depending on the resolution of the texture, or how close you are to the model when applying paint.

Good paintable areas are areas where you can apply paint or other adjustments to the model surface with the most consistent and predictable effect. In other areas, paint may be undersampled or oversampled due to your angle or distance from the model surface.

❖ Do one of the following:

- Choose 3D > Select Paintable Areas. A selection marquee highlights the best areas for painting on the model.
- In Scene section  of the 3D panel, choose Paint Mask from the Preset menu.

In Paint Mask mode, white shows areas good for painting, blue shows areas where paint will be undersampled, and red shows areas where paint will be oversampled. (To paint on the model, you must change from the Paint Mask render mode to a render mode that supports painting, such as Solid.)

 The areas selected by **Select Paintable Areas**, and the paintable areas shown in **Paint Mask** mode, are partially determined by the current **Paint Falloff** setting. A higher paint falloff setting increases the paintable area, a lower setting decreases the paintable area. See “[Set the paint falloff angle](#)” on page 589.

Create 3D objects from 2D images (Photoshop Extended)

Photoshop can build a variety of basic 3D objects using 2D layers as a starting point. After creating a 3D object, you can move it in 3D space, change render settings, add lighting, or merge it with other 3D layers.

- Convert a 2D layer (or multiple layers) into a 3D postcard, a plane with 3D properties. If your starting layer is a text layer, any transparency is retained.

 You can add a 3D postcard to an existing 3D scene to create a surface that displays shadows and reflections from other objects in the scene.

- Wrap a 2D layer around a 3D object, such as a cone, cube, or cylinder.
- Create an extruded 3D mesh from the grayscale information in a 2D image.
- Build a 3D volume from a multi-frame file such as a DICOM medical imaging file. Photoshop combines the individual slices of the file into a 3D object that you can manipulate in 3D space and view from any angle. You can apply various 3D volume render effects to optimize the display of various materials in the scan, such as bone or soft tissue. See “[Create a 3D volume \(Photoshop Extended\)](#)” on page 599.

For a video about creating 3D content from 2D layers, see www.adobe.com/go/lrvid4006_ps.

Create a 3D postcard

- 1 Open a 2D image and select the layer you want to convert to a postcard.
- 2 Choose **3D > New 3D Postcard From Layer**.
 - The 2D layer is converted to a 3D layer in the Layers panel. The 2D layer content is applied as a material to both sides of the postcard.
 - The original 2D layer appears in the Layers panel as the Diffuse texture map for the 3D postcard object. (See “[3D panel overview \(Photoshop Extended\)](#)” on page 575.)
 - The 3D layer retains the dimensions of the original 2D image.
- 3 (Optional) To add the 3D postcard as a surface plane to a 3D scene, merge the new 3D layer with an existing 3D layer containing other 3D objects, then align it as necessary. (See “[Combine 3D objects \(Photoshop Extended\)](#)” on page 591.)
- 4 To retain the new 3D content, export the 3D layer in a 3D file format or save it in PSD format. (See “[Export a 3D layer](#)” on page 597.)

Create 3D shapes

Depending on the object type you choose, the resulting 3D model can contain one or more meshes. The **Spherical Panorama** option maps a panoramic image inside a 3D sphere.

- 1 Open a 2D image and select the layer that you want to convert to a 3D shape.
- 2 Choose **3D > New Shape From Layer**, and select a shape from the menu. Shapes include single-mesh objects like a donut, sphere, or hat, as well as multiple mesh objects such as a cone, cube, cylinder, soda can, or wine bottle.

Note: You can add your own custom shapes to the shape menu. Shapes are Collada (.dae) 3D model files. To add a shape, place the Collada model file in the **Presets\Meshes** folder inside the Photoshop program folder.

- The 2D layer is converted to a 3D layer in the Layers panel.

- The original 2D layer appears in the Layers panel as a Diffuse texture map. It may be used on one or more surfaces of the new 3D object. Other surfaces may be assigned a default diffuse texture map with a default color setting. See “[3D panel overview \(Photoshop Extended\)](#)” on page 575.
- 3 (Optional) Use the Spherical Panorama option if you are using a panoramic image as your 2D input. This option converts a complete 360 x 180 degree spherical panorama to a 3D layer. Once converted to a 3D object, you can paint areas of the panorama that are typically difficult to reach, such as the poles or areas containing straight lines. For information on creating a 2D panorama by stitching images together, see “[Create 360 degree panoramas](#)” on page 245.
 - 4 Export the 3D layer in a 3D file format or save in PSD format to retain the new 3D content. See “[Export a 3D layer](#)” on page 597.

Create a 3D mesh

The New Mesh from Grayscale command converts a grayscale image into a depth map, which translates lightness values into a surface of varying depth. Lighter values create raised areas in the surface, darker values create lower areas. Photoshop then applies the depth map to one of four possible geometries to create a 3D model.

- 1 Open a 2D image and select one or more layers that you want to convert to a 3D mesh.
- 2 (Optional) Convert the image to grayscale mode. (Choose Image > Mode > Grayscale, or use Image > Adjustments > Black & White to fine-tune the grayscale conversion.

Note: If you use an RGB image as input when creating a mesh, the green channel is used to generate the depth map.

- 3 (Optional) Make adjustments to the grayscale image if necessary to limit the range of lightness values.
- 4 Choose 3D > New Mesh From Grayscale, and then select a mesh option.

Plane Applies depth map data to a planar surface.

Two-Sided Plane Creates two planes reflected along a central axis and applies depth map data to both planes.

Cylinder Applies depth map data outward from the center of a vertical axis.

Sphere Applies depth map data radially outward from a center point.

Photoshop creates a 3D layer containing the new mesh. It also creates Diffuse, Opacity, and Planar Depth Map texture maps for the 3D object, using the original grayscale or color layer.

Note: The Opacity texture map does not appear in the Layers panel, because that map uses the same texture file as the Diffuse map (the original 2D layer). When two texture maps reference the same file, the file appears only once in the Layers panel.

You can reopen the Planar Depth Map as a Smart Object at any time and edit it. When you save it, the mesh is regenerated.

Combine 3D objects (Photoshop Extended)

Merging 3D layers allows you to combine multiple 3D models in one scene. Once combined, each 3D model can be manipulated separately, or you can use position and camera tools on all models simultaneously.

- 1 Open two document windows, each containing a 3D layer.
- 2 Make the source document (the file from which you are copying the 3D layer) active.
- 3 Select the 3D layer in the Layers panel and drag it into the window of the target document (the file which will contain the combined 3D objects).

The 3D layer is added as a new 3D layer in the target document. It becomes the active layer in the Layers panel of the target document.

4 In the Tools panel, select a 3D camera tool.

5 In the options bar, from the Position menu, select the layer name for the original 3D layer in the target file.

After you match the camera position of the two 3D layers, the two 3D objects appear together in the scene. Use the 3D object tools to reposition the objects before merging.

6 From the Layers panel options menu , choose Merge Down.

The two 3D layers are combined into one 3D layer. The point of origin of each model is aligned.

Note: Depending on the size of each 3D model, one model may appear partially or completely embedded in the other model after merging 3D layers.

After merging two 3D models, all meshes and materials from each 3D file are contained in the target file and appear in the 3D panel. In the Meshes panel, you can select and reposition individual meshes using the 3D position tools in the panel. See “[3D Mesh settings \(Photoshop Extended\)](#)” on page 578.



To alternate between moving all models at once and moving individual models in the layer, switch between the 3D position tools in the Tools panel and the tools in the Meshes panel.

Combine 3D and 2D layers (Photoshop Extended)

You can combine 3D layers with one or more 2D layers to create composite effects. For example, you can place a model against a background image and change its position or viewing angle to match the background.

❖ Do one of the following:

- With the 2D file open, choose 3D > New Layer from 3D File, and open a 3D file.
- With both a 2D file and a 3D file open, drag either the 2D or 3D layer from one file into the open document window of the other file. The layer you add moves to the top of the Layers panel.

When working in a file with combined 2D and 3D layers, you can temporarily hide the 2D layers while working with the 3D layer. See “[Hide layers for better performance](#)” on page 592.

Hide layers for better performance

In a multi-layer document with 2D layers above a 3D layers, you can temporarily move the 3D layer to the top of the layer stack for faster screen rendering.

1 Choose 3D > Auto-Hide Layers For Performance.

2 Select a 3D Position or Camera tool.

When you hold down the mouse button with either tool, all 2D layers are temporarily hidden. When you release the mouse, all 2D layers reappear. Moving any part of the 3D Axis also hides all 2D layers.

Create 3D animations (Photoshop Extended)

Using the Photoshop Animation timeline, you can create 3D animations that move a 3D model through space and change the way it displays over time. You can animate any of the following properties of a 3D layer:

- 3D object or camera position. Use the 3D position or camera tools to move the model or 3D camera over time. Photoshop can tween frames between position or camera movements to create smooth motion effects.

- 3D render settings. Change render modes, with the ability to tween transitions between some render modes. For example, change Vertices mode gradually to Wireframe over time, to simulate the sketching-in of a model's structure.
- 3D cross section. Rotate an intersecting plane to display a changing cross section over time. Change cross section settings between frames to highlight different model areas during an animation.

For high quality animations, you can render each animation frame using the Render for Final Output render setting. See “[Change render settings for 3D models \(Photoshop Extended\)](#)” on page 593.

See also

“[Creating timeline animations \(Photoshop Extended\)](#)” on page 554

Convert a 3D layer to a 2D layer (Photoshop Extended)

Converting a 3D layer to a 2D layer rasterizes the 3D content in its current state. Convert a 3D layer to a regular layer only if you no longer want to edit the 3D model position, render mode, textures, or lights. The rasterized image retains the appearance of the 3D scene, but in a flattened 2D format.

- ❖ Select the 3D layer in the Layers panel, and choose 3D > Rasterize.

Convert a 3D layer to a Smart Object (Photoshop Extended)

Converting a 3D layer to a Smart Object allows you to retain the 3D information contained in the 3D layer. After converting, you can apply transforms or other adjustments like Smart Filters to the Smart Object. You can reopen the Smart Object layer to edit the original 3D scene. Any transforms or adjustments applied to the Smart Object are then applied to the updated 3D content.

- 1 Select the 3D layer in the Layers panel.
- 2 From the Layers panel option menu, choose Convert to Smart Object.
- 3 (Optional) To reedit the 3D content, double-click the Smart Object layer in the Layers panel.

See also

“[About Smart Objects](#)” on page 310

Change render settings for 3D models (Photoshop Extended)

Render settings determine how 3D models are drawn. Photoshop provides default presets with common settings. Customize settings to create your own presets.

Note: Render settings are layer-specific. If a document contains multiple 3D layers, specify separate render settings for each.

Select a render preset

The standard render preset is Solid, which displays the visible surfaces of models. Wireframe and Vertices presets reveal the underlying structure. To combine solid and wireframe rendering, choose the Solid Wireframe preset. To view a model as a simple box reflecting its outermost dimensions, choose a Bounding Box preset.

- 1 At the top of the 3D panel, click the Scene button .
- 2 In the lower half of the panel, choose an option from the Preset menu.

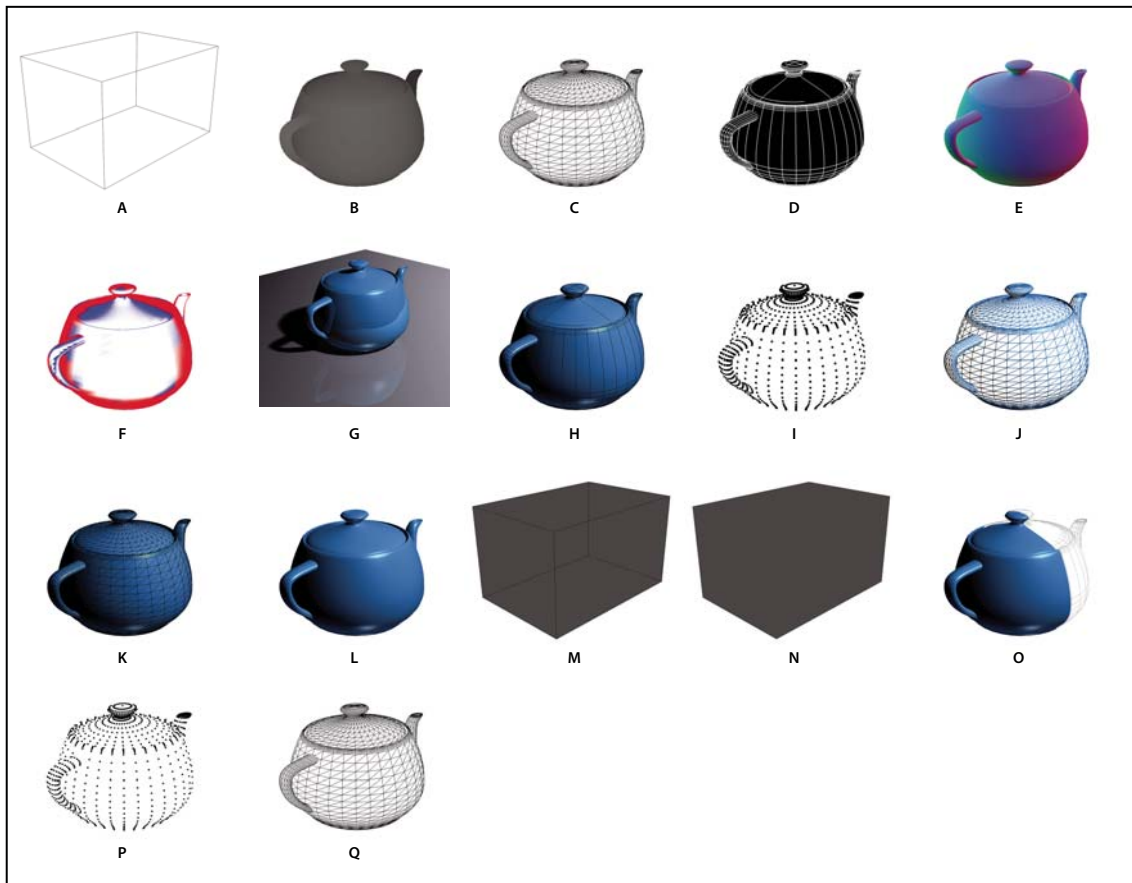



Default render presets

A. Bounding Box B. Depth Map C. Hidden Wireframe D. Line Illustration E. Normals F. Paint mask G. Ray Traced (with ground plane) H. Shaded Illustration I. Shaded Vertices J. Shaded Wireframe K. Solid Wireframe L. Solid M. Transparent Bounding Box Outline N. Transparent Bounding Box O. Two-Sided P. Vertices Q. Wireframe

💡 The Two-Sided preset applies only to cross sections, displaying a solid model on one half of the section, and a wireframe on the other.

Customize render settings

- 1 At the top of the 3D panel, click the Scene button .
- 2 Click Render Settings.
- 3 (Optional) To see the effect of new settings as you make changes, select Preview. Or, deselect this option to slightly improve performance.

💡 To specify unique settings for each half of a cross section, click the cross section buttons  at the top of the dialog box.

- 4 Enable Face, Edge, Vertex, Volume, or Stereo rendering by clicking the checkboxes on the left side of the dialog box. Then adjust the related settings below.

💡 For information about Volume options, used primarily with DICOM images, see “View a 3D volume in different render modes” on page 599.

Face options

Face options determine how model surfaces appear.

Face Style Draws surfaces using any of these methods:

- **Solid** Draws without shadows or reflections using the GPU on an OpenGL video card.
- **Ray Traced** Draws with shadows, reflections, and refractions using the CPU on the computer motherboard.
- **Unlit Texture** Draws without lighting, instead displaying only the selected Texture option. (Diffuse is selected by default.)
- **Flat** Applies the same surface normal for all vertices in a face, creating a faceted look.
- **Constant** Replaces textures with currently specified color.

 *To adjust face, edge, or vertex color, click the Color box.*

- **Bounding Box** Displays boxes reflecting the outermost dimensions of each component.
- **Normals** Displays X, Y, and Z components for surface normals in different RGB colors.
- **Depth Map** Displays a gray model, using luminosity to reveal depth.
- **Paint Mask** Displays paintable regions as white, oversampled regions in red, and undersampled regions in blue. (See “[Identify paintable areas](#)” on page 589.)

Texture When Face Style is set to Unlit Texture, specifies the texture map. (See “[3D Materials settings \(Photoshop Extended\)](#)” on page 579.)

Render For Final Output For exported video animations, produces smoother shadows and realistic color bleeds from reflected objects and environments. This option requires more processing time, however.

Reflections, Refractions, Shadows Show or hide these Ray Traced-specific features.

Remove Backfaces Hides surfaces on the back of two-sided components.

Edge options

Edge options determine how wireframe lines appear.

Edge Style Reflects the Constant, Flat, Solid, and Bounding Box options described for Face Style above.

Crease Threshold Adjusts the number of structural lines that appear in the model. A crease or line, is formed when two polygons in a model come together at a particular angle. If edges meet at an angle below the Crease Threshold setting (0-180), the line they form is removed. At a setting of 0, the entire wireframe is displayed.

Line Width Specifies width in pixels.

Remove Backfaces Hides edges on the back of two-sided components.

Remove Hidden Lines Removes lines that foreground lines overlap.

Vertex options

Vertex options adjust the appearance of *vertices* (intersections of polygons that make up the wireframe model).

Vertex Style Reflects the Constant, Flat, Solid, and Bounding Box options described for Face Style above.

Radius Determines the pixel radius of each vertex.

Remove Backfaces Hides vertices on the back of two-sided components.

Remove Hidden Vertices Removes vertices that foreground vertices overlap.

Stereo options

Stereo options adjust settings for images that will either be viewed with red-blue glasses or printed to objects that include a lenticular lens.



Stereo Type Specifies Red/Blue for images viewed with colored glasses or Vertical Interlaced for lenticular prints.

Parallax Adjusts the distance between the two stereo cameras. Higher settings increase three-dimensional depth but reduce depth of field, making items ahead or behind the focal plane appear out of focus.

Lenticular Spacing For vertically interlaced images, specifies how many lines per inch the lenticular lens has.

Focal Plane Determines the position of the focal plane relative to the center of the model's bounding box. Enter negative values to move the plane forward, and positive values to move it backward.

Save or delete a render preset

- 1 At the top of the 3D panel, click the Scene button .
- 2 Click Render Settings.
- 3 Do either of the following:
 - To save a preset, customize settings, and click the Save button .
 - To delete a preset, select it from the Preset menu, and click the Delete button .

Render a 3D file for final output (Photoshop Extended)

When you've finished working with your 3D file, create a final render to produce the highest quality version for output to web, print, or animation. Final rendering uses ray tracing and a higher sampling rate to capture more realistic lighting and shadow effects.

Use final render mode to enhance the following effects in your 3D scene:

- Image based lighting and global ambient color.
- Lighting from object reflectance (color bleed).
- Reduced noise in soft shadows.

Note: A final render can be time-consuming, depending on the model, lighting, and maps in your 3D scene.

- 1 Make any necessary adjustments to your model, including lighting and shadow effects.



You don't need to change Anti-Alias settings for the scene before rendering. By default, the Best setting is used.

- 2 Choose 3D > Render for Final Output.

After the render is complete, you can flatten the 3D scene for output in another format, composite the 3D scene with 2D content, or print directly from the 3D layer.

Any change to the 3D layer, such as moving the model or changing the lighting, disables the final render and returns to the previous render setting.



Render for Final Output is available as an option when exporting a 3D animation. Each frame in the animation is rendered for final output when the animation is created. See "Change render settings for 3D models (Photoshop Extended)" on page 593.

Saving and exporting 3D files (Photoshop Extended)

To preserve the 3D content in a file, save the file in Photoshop format or another supported image format. You can also export a 3D layer as a file in a supported 3D file format.

Export a 3D layer

You can export 3D layers in all supported 3D formats: Collada DAE, Wavefront/OBJ, U3D, and Google Earth 4 KMZ. When choosing an export format, consider the following factors:

- Texture layers are saved in all 3D file formats; however, U3D preserves only Diffuse, Environment, and Opacity texture maps.
- Wavefront/OBJ format does not save camera settings, lights, or animation.
- Only Collada DAE saves render settings.

To export a 3D layer, do the following:

- 1 Choose 3D > Export 3D layer
- 2 Choose a format for exporting textures:
 - U3D and KMZ support JPEG or PNG as texture formats.
 - DAE and OBJ support all Photoshop-supported image formats for textures.
- 3 (Optional) If exporting to U3D format, choose an encoding option. ECMA 1 is compatible with Acrobat 7.0; ECMA 3 is compatible with Acrobat 8.0 and later and provides some mesh compression.
- 4 Click OK to export.

Save a 3D file

To preserve 3D model position, lighting, render mode, and cross sections, save files with 3D layers in PSD, PSB, TIFF, or PDF format.

- ❖ Choose File > Save or File > Save As, select Photoshop (PSD), Photoshop PDF, or TIFF format, and click OK.

DICOM files (Photoshop Extended)

About DICOM files (Photoshop Extended)

DICOM (an acronym for Digital Imaging and Communications in Medicine) is the most common standard for receiving medical scans. Photoshop Extended allows you to open and work with DICOM (.dc3, .dcm, .dic, or no extension) files. DICOM files can contain multiple “slices” or frames, which represent different layers of a scan.

Photoshop reads all frames from a DICOM file and converts them to Photoshop layers. Photoshop can also place all DICOM frames in a grid on one layer, or open frames as a 3D volume which you can rotate in 3D space. Photoshop can read 8-, 10-, 12-, or 16-bit DICOM files. (Photoshop converts 10- and 12-bit files to 16-bit files.)

Once you’ve opened a DICOM file in Photoshop, you can use any Photoshop tool to adjust, mark up, or annotate the file. For example, use the Notes tool to add a comment to the file, the Pencil tool to mark a specific area of the scan or the Dust And Scratches filter to remove dust or scratches from a scan. Use the Ruler or selection tools to make measurements of image content.

Note: Any measurement scale present in a DICOM file is automatically imported with the file. If no scale is present, the default scale of 1 pixel = 1 mm is added as a custom measurement scale. See “[Set the measurement scale \(Photoshop Extended\)](#)” on page 601.

You can save 8-bit DICOM files in any file format Photoshop supports (16-bit files must be saved as DICOM, Large Document Format, Photoshop, Photoshop PDF, Photoshop Raw, PNG, or TIFF files).

Important: When you save a file as DICOM, any layer styles, adjustments, blend modes, or masks are discarded.

You can also view and edit metadata for DICOM files in Bridge or in the Photoshop File Info dialog box. DICOM files support external automation through scripting (see “[About scripting](#)” on page 626).

For a video about DICOM files, see www.adobe.com/go/vid0028.

See also

“[About notes](#)” on page 465

“[Paint with the Brush tool or Pencil tool](#)” on page 329

“[Apply the Dust And Scratches filter](#)” on page 398

[About DICOM files video](#)

Open a DICOM file (Photoshop Extended)

Before you open a DICOM file, you can specify how DICOM frames are opened (as layers, in a grid, or as a 3D volume), and set options (in the DICOM File Import dialog box) that anonymize patient metadata and display overlays. During the import you can also perform pans, zooms, and window leveling.

The DICOM import dialog box also displays DICOM header information—textual information about the file, such as its dimensions, data resolution, and whether the data has been compressed.

 You can import a sequence of multiple, single-frame DICOM files into a single multilayered Photoshop file, using the [New Video Layer from File](#) command. See “[Import image sequences \(Photoshop Extended\)](#)” on page 537.

For a video on opening DICOM files, see www.adobe.com/go/vid0028.

- 1 Choose File > Open, select a DICOM file, and click Open.
- 2 Select the frames you want to open. Shift-click to select contiguous frames. To select noncontiguous frames, Ctrl-click (Windows) or Command-click (Mac OS). Click Select All to select all frames.

 To quickly scroll through frames, use the mouse scroll wheel (Windows) or click the Right or Left Arrow buttons below the large preview area.

- 3 Choose from the following options, and then click Open.

Frame Import Import Frames As Layers places DICOM frames on layers. N-Up Configuration displays multiple frames in a grid (enter values in the Rows and Columns boxes to specify height and width of grid). Import as volume opens the DICOM frames as a volume, where the z-distance is determined by DICOM settings and data is interpolated between the frames. You can view the volume from any angle, using a variety of rendering modes to highlight data.

DICOM Dataset Anonymize overwrites patient metadata with “anonymize.” Show Overlays displays overlays such as annotations, curves, or text.

Windowing Select Show Windowing Options to adjust the contrast (Window Width) and brightness (Window Level) of the frame. Alternatively, you can drag the Window Level tool up or down to adjust the level, or to the right or left to adjust the width. You can also choose common radiology presets from the Window Preset menu (Default, Lung, Bone, or Abdomen). Select Reverse Image to invert the brightness values of the frame.

 To zoom, choose a zoom level from the Select Zoom Level menu (or click the plus and minus signs to zoom in and out).
To pan, click the Hand icon at the top of the dialog box and drag across the frame.

Create a 3D volume (Photoshop Extended)

- 1 Choose File > Open, select a DICOM file, and click Open.
- 2 Select the frames you want to convert to a 3D volume. Shift-click to select contiguous frames. To select noncontiguous frames, Ctrl-click (Windows) or Command-click (Mac OS). Click Select All to select all frames.
- 3 In Frame Import Options, select Import as volume, then click Open.



Photoshop creates a 3D volume of the DICOM frames and places it on a 3D layer in the Layers panel. You can use Photoshop's 3D position tools to view the 3D volume from any angle, or change render settings to better visualize data.

- The original DICOM file is preserved as a Diffuse texture layer associated with the 3D volume layer. For information on 3D textures, see “[Create and edit textures for 3D models \(Photoshop Extended\)](#)” on page 584.
- Double-click the texture layer to open the DICOM file as a Smart Object in its own document window. The DICOM frames appear as separate layers in the Layers panel.
- Any changes you make to individual layers are applied to the 3D volume when you close and save the Smart Object.

To save the 3D volume, you can export the 3D layer or save the file in PSD format. See “[Export a 3D layer](#)” on page 597 and “[Save a 3D file](#)” on page 597.

For a video about creating a 3D volume from DICOM frames, see www.adobe.com/go/lrvid4006_ps.

View a 3D volume from different angles

- 1 Select the 3D layer containing the DICOM volume in the Layers panel.
- 2 Select either the 3D Position tool  or a 3D camera tool  in the Tools panel.
- 3 Use the position or camera tools in the options bar to rotate, move, or scale the 3D volume. See “[Using the 3D tools \(Photoshop Extended\)](#)” on page 572.

 If OpenGL support is enabled on your system, you can also use the 3D Axis to rotate, move, or scale the 3D volume. See “[Using the 3D Axis \(Photoshop Extended\)](#)” on page 574.

View a 3D volume in different render modes

- 1 Select the 3D layer containing the DICOM volume in the Layers panel.
- 2 Choose Window > 3D to open the 3D panel.
- 3 From the Preset menu in the lower section of the 3D panel, select a render mode.

Note: Render modes that use a transfer function use a Photoshop gradient to render values in the volume. The gradient color and opacity values are combined with the grayscale values in the volume to optimize or highlight different types of content. Transfer function render modes are only available for grayscale DICOM images.

Enhanced Boundaries Lowers the opacity of homogeneous regions while retaining the opacity of the boundaries. It can also reduce noise in the volume.

Full Range Color Scale Transfer function that uses a full “rainbow” Photoshop color gradient.

High Range Highlights Transfer function that uses the color white for the entire value range, zero opacity for low range values, and high opacity for high range values.

Low Range Highlights Transfer function that uses the color white for the entire value range, zero opacity for high range values, and high opacity for low range values.

Maximum Intensity Projection Displays maximum values in the volume to provides a quick preview of volume structure. Does not provide any depth cues.

Red-Blue Color Scale Transfer function that uses a full red-blue color gradient.

Thin Isolines Transfer function that uses constant color, while opacity component is a function with multiple spikes, to display isovalues.

X-Ray Approximates X-ray radiation transport through an X-ray translucent medium. This effect is useful for generating an image from a CT scan that looks like an X-ray shot of the same object.

White-Black Color Scale Transfer function using a white-black color component.

- 4 (Optional) To create a custom render mode, click Render Settings in the 3D panel to open the 3D Render Settings dialog box. Select options in the Volume Styles section of the dialog. See [“Change render settings for 3D models \(Photoshop Extended\)”](#) on page 593.

Export DICOM frames as JPEG files (Photoshop Extended)

- 1 Open a DICOM file and set options in the DICOM File Import dialog box (see [“Open a DICOM file \(Photoshop Extended\)”](#) on page 598).
- 2 Select frames in the DICOM File Import dialog box: Shift-click to select contiguous frames, Ctrl-click (Windows) or Command-click (Mac OS) to select noncontiguous frames, or click Select All to select all frames.
- 3 Enter a prefix in the Prefix box in the Export Options area.
- 4 Click Export Presentation (JPEG), select a folder, and click Select.

The JPEG files are saved in the specified location with the prefix added to the filenames. If you selected multiple frames, Photoshop appends successive numbering to the end of each filename (for example, DICOM Frame1, DICOM Frame2, DICOM Frame3).

DICOM metadata (Photoshop Extended)

You can view and edit several categories of DICOM metadata in the Photoshop File Info dialog box.

Patient data Includes patient name, ID, sex, and date of birth.

Study data Includes study ID, referring physician, study date and time, and study description.

Series data Includes series number, modality, series date and time, and series description.

Equipment data Includes the equipment institution and manufacturer.

Image data Includes the transfer syntax, photometric interpretation, image width and height, bits per pixel, and frames. (These fields are not editable.)

See also

[“About metadata”](#) on page 464

[Opening and editing DICOM files video](#)

Animate DICOM files (Photoshop Extended)

To animate DICOM slices or frames, select all DICOM layers and choose Make Frames From Layers from the Animation (Timeline) panel menu.

After creating frames in the (Animation) Timeline panel, you can save DICOM files as QuickTime movies (change grayscale DICOM files to RGB, and then render to video). You can also save frames as animated GIF files (choose File > Save for Web and Devices).

You can also use the Timeline panel to animate a 3D volume created from a DICOM file. See “[Create 3D animations \(Photoshop Extended\)](#)” on page 592.

See also

“[Export video files or image sequences](#)” on page 564

“[Creating frame animations](#)” on page 547

“[Timeline animation workflow \(Photoshop Extended\)](#)” on page 554

[Opening and editing DICOM files video](#)

Measurement (Photoshop Extended)

About measurement (Photoshop Extended)

Using the Photoshop Extended Measurement feature you can measure any area defined with the Ruler tool or with a selection tool, including irregular areas selected with the Lasso, Quick Select, or Magic Wand tools. You can also compute the height, width, area, and perimeter, or track measurements of one image or multiple images. Measurement data is recorded in the Measurement Log panel. You can customize the Measurement Log columns, sort data within columns, and export data from the log to a tab-delimited, Unicode text file.

For a video on measurement features, see www.adobe.com/go/vid0029.

Measurement scale

Setting a measurement scale sets a specified number of pixels in the image equal to a number of scale units, such as inches, millimeters, or microns. Once you’ve created a scale, you can measure areas and receive calculations and log results in the selected scale units. You can create multiple measurement scale presets, although only one scale can be used in a document at a time.

Scale markers

You can place scale markers on an image to display the measurement scale. Scale markers can appear with or without a caption displaying measurement scale units.

See also

[Measurement features video](#)

Set the measurement scale (Photoshop Extended)

Use the Ruler tool to set the measurement scale for a document. You can create measurement scale presets for frequently used measurement scales. Presets are added to the Analysis > Set Measurement Scale submenu. The current measurement scale for a document is checked in the submenu, and appears in the Info panel.

Note: Measurement scale is set automatically for DICOM files. See “[About DICOM files \(Photoshop Extended\)](#)” on page 597.

Choose Analysis > Set Measurement Scale > Default to return to the default measurement scale, 1 pixel = 1 pixel.

Set measurement scale

- 1 Open a document.
- 2 Choose Analysis > Set Measurement Scale > Custom. The Ruler tool is automatically selected. Drag the tool to measure a pixel distance in the image or enter a value in the Pixel Length text box. Your current tool setting is restored when you close the Measurement Scale dialog box.
- 3 Enter the Logical Length and Logical Units that you want to set equal to the Pixel Length.

For example, if the Pixel Length is 50, and you want to set a scale of 50 pixels per micron, enter 1 for Logical Length, and microns for the Logical Units.

- 4 Click OK in the Measurement Scale dialog box to set the measurement scale on the document.
- 5 Choose File > Save to save the current measurement scale setting with the document.

To display the scale in the Info panel, choose Panel Options from the panel menu , and select Measurement Scale in the Status Information area.

 *To display the measurement scale at the bottom of the document window, choose Show > Measurement Scale from the document window menu.*

Create a measurement scale preset

- 1 Open a document.
- 2 Choose Analysis > Set Measurement Scale > Custom.
- 3 Create a measurement scale.
- 4 Click Save Preset and name the preset.
- 5 Click OK. The preset you created is added to the Analysis > Set Measurement Scale submenu.

Delete a measurement scale preset

- 1 Choose Analysis > Set Measurement Scale > Custom.
- 2 Select the preset you want to delete.
- 3 Click Delete Preset and click OK.

Use scale markers (Photoshop Extended)

Measurement scale markers display the measurement scale used in your document. Set the measurement scale for a document before creating a scale marker. You can set the marker length in logical units, include a text caption indicating the length, and set the marker and caption color to black or white.

Create a scale marker

- 1 Choose Analysis > Place Scale Marker.
- 2 In the Measurement Scale Marker dialog box, set the following options:
 - Length** Enter a value to set the length of the scale marker. The length of the marker in pixels depends on the measurement scale that is currently selected for the document.
 - Font** Choose the font for the display text.
 - Font Size** Choose the font size for the display text.
 - Display Text** Select this option to show the logical length and units for the scale marker.

Text position Displays caption above or below the scale marker.

Color Sets the scale marker and caption color to black or white.

3 Click OK.

The scale marker is placed in the lower left corner of the image. The marker adds a layer group to the document, containing a text layer (if the Display Text option is selected) and a graphic layer. You can use the Move tool to move the scale marker, or the Text tool to edit the caption or change text size, font, or color.

For a video on understanding and using the measurement features, see www.adobe.com/go/vid0029.

Add or replace scale markers

You can place multiple scale markers in a document, or replace existing markers.

Note: Additional scale markers are placed in the same position on the image and can obscure each other, depending on their length. To view an underlying marker, turn off the scale marker layer set.

- 1 Choose Analysis > Place Scale Marker.
- 2 Click Remove or Keep.
- 3 Enter settings for the new marker and click OK.

Delete a scale marker

- 1 In the Layers panel, select the Measurement Scale Marker layer group for the scale marker you want to delete.
- 2 Right-click the layer group and select Delete Group from the context menu, or click the Delete Layer button.
- 3 Click Group and Contents.

Performing a measurement (Photoshop Extended)

You can measure using the Photoshop selection tools, Ruler tool, or Count tool. Choose a measurement tool that matches the type of data you want to record in the Measurement Log.

- Create a selection area to measure values such as height, width, perimeter, area, and pixel gray values. You can measure one selection or several selections at once.
- Draw a line with the Ruler tool to measure linear distance and angle.
- Use the Count tool to count items on the image, then record the number of items (see “[About counting \(Photoshop Extended\)](#)” on page 607).

Each measurement measures one or more *data points*. The data points you select determine the information recorded in the Measurement log. Data points correspond to the type of tool you’re measuring with. Area, perimeter, height, and width are available data points for measuring selections. Length and angle are available data points for Ruler tool measurements. You can create and save sets of data points for particular types of measurements to speed your workflow.

- 1 Open an existing document.
- 2 Choose Analysis > Set Measurement Scale and choose a measurement scale preset for the document (see “[Set the measurement scale \(Photoshop Extended\)](#)” on page 601), or choose Custom and set a custom measurement scale.

Measurements are computed and recorded in the Measurement Log using the scale units in effect when a measurement is recorded. If no measurement scale exists, the default scale is 1 pixel = 1 pixel.

3 (Optional) Choose Analysis > Select Data Points and do one of the following:

- Choose Custom to select data points to measure.
- Select an existing data point preset from the submenu.

For a video on understanding and using the measurement features, see www.adobe.com/go/vid0029.

In the Select Data Points dialog box, data points are grouped according to the measurement tool that can measure them. The Common data points are available for all tools. They add useful information to the Measurement Log such as the name of the file being measured, the measurement scale, and the date/time of the measurement.

By default all data points are selected. You can select a subset of data points for a particular type of measurement, then save the combination as a data point preset.

Note: When you measure with a particular tool, only the data points associated with that tool are displayed in the log, even if other data points are selected. For example, if you make a measurement with the Ruler tool, only the Ruler tool data points appear in the Measurement Log, along with any Common data points that are selected.

4 Choose an image feature and measurement tool to match the selected data points. Do one of the following:

- Create one or more selections on the image.
- Choose Analysis > Ruler Tool, or click the Ruler tool in the toolbox, then use the tool to measure the length of an image area.
- Choose Analysis > Count Tool, or click the Count tool in the toolbox, then count items in the image.

5 Choose Window > Measurement Log to open the Measurement Log panel.

6 Choose Analysis > Record Measurements, or click Record Measurements in the Measurement Log panel.

Note: If your currently selected data points do not correspond to the current measurement tool, you are asked to select data points for that tool.

The Measurement log has columns for each data point you selected in the Measurement Data Points dialog box. Each measurement you make enters a new row of data in the Measurement Log.

If you measure multiple selected areas on the image, one row of data is created in the log containing summary or cumulative data for all selected areas, followed by a row of data for each selection area. Each selection area is listed as a separate Feature in the Label column of the log and assigned a unique number.

You can repeat steps 2 through 6 for a variety of different selections in the same or multiple documents. The Document column in the Measurement Log reflects the source of the measurement data.

Measurement Data Points

Angle Angle of orientation (± 0 -180) of the Ruler tool.

Area Area of selection in square pixels, or in calibrated units according to the current measurement scale (such as square millimeters).

Circularity $4\pi(\text{area}/\text{perimeter}^2)$. A value of 1.0 indicates a perfect circle. As the value approaches 0.0, it indicates an increasingly elongated polygon. Values may not be valid for very small selections.

Count Varies according to the measuring tool used. Selection tool: the number of discontinuous selection areas on the image. Count tool: the number of counted items on the image. Ruler tool: the number of Ruler lines visible (1 or 2).

Date and Time Applies a date/time stamp of when the measurement occurred.

Document Identifies the document (file) measured.

Gray Value This is a measurement of brightness, either from 0 to 255 (for 8-bit images), 0 to 32,768 (for 16-bit images), or 0.0 to 10 (for 32-bit images). For all gray value-related measurements, the image is internally converted to grayscale (equivalent to choosing Image > Mode > Grayscale) using the default grayscale profile. Then the requested calculations (mean, median, minimum, maximum) are calculated for each feature and for the summary.

Height Height of the selection (max y - min y), in units according to the current measurement scale.

Histogram Generates histogram data for each channel in the image (three for RGB images, four for CMYK, and so on), recording the number of pixels at each value from 0 to 255 (16-bit or 32-bit values are converted to 8-bit). When you export data from the Measurement Log, the numeric histogram data is exported to a CSV (comma-separated value) file. The file is placed in its own folder at the same location where the measurement log tab-delimited text file is exported. Histogram files are assigned a unique number, starting at 0, and progressing by 1. For multiple selections measured at once, one histogram file is generated for the total selected area, plus additional histogram files for each selection.

Integrated Density The sum of the values of the pixels in the selection. This is equivalent to the product of Area (in pixels) and Mean Gray Value.

Label Identifies and automatically numbers each measurement as Measurement 1, Measurement 2, and so on. For multiple selections measured simultaneously, each selection is assigned an additional Feature label and number.

Length Linear distance defined by the Ruler tool on the image, in units according to the current measurement scale.

Perimeter The perimeter of the selection. For multiple selections measured at once, one measurement is generated for the total perimeter of all selections, plus additional measurements for each selection.

Scale The measurement scale of the source document (for example, 100 px = 3 miles).

Scale Units Logical units of the measurement scale.

Scale Factor The number of pixels assigned to the scale unit.

Source Source of the measurement: Ruler tool, Count Tool, or Selection.

Width Width of the selection (max x - min x), in units according to the current measurement scale.

Create a data point preset

- 1 Choose Analysis > Select Data Points > Custom.
- 2 Select data points to include in the preset.
- 3 Click Save Preset and name the preset.
- 4 Click OK. The preset is saved and is now available from the Analysis > Select Data Points submenu.

Edit a data point preset

- 1 Choose Analysis > Select Data Points > Custom.
- 2 Choose the preset you want to edit from the Preset menu.
- 3 Select or deselect data points. The Preset name changes to Custom.
- 4 Click Save Preset. Enter the original preset name to replace the existing preset, or a new name to create a new preset.

Delete a data point preset

- 1 Choose Analysis > Select Data Points > Custom.
- 2 Choose the preset you want to delete from the Preset menu.
- 3 Click Delete Preset, then Yes to confirm the deletion.

- 4 Click OK.

Use the Measurement Log (Photoshop Extended)

When you measure an object, the Measurement Log panel records the measurement data. Each row in the log represents a measurement set; columns represent the data points in a measurement set.

When you measure an object, a new row appears in the Measurement Log. You can reorder columns in the log, sort data in columns, delete rows or columns, or export data from the log to a comma-delimited text file.

For a video on understanding and using the measurement features, see www.adobe.com/go/vid0029.

Display the Measurement Log

- ❖ Do one of the following:
 - Choose Analysis > Record Measurements.
 - Choose Window > Measurement Log.

Select rows in the log

- ❖ Do one of the following:
 - Click a row in the log to select it.
 - To select multiple contiguous rows, click the first row and drag through additional rows, or click the first row and then Shift-click the last row.
 - To select noncontiguous rows, click the first row and then Ctrl-click (Windows) or Command-click (Mac) additional rows.
 - To select all rows, click Select All.
 - To deselect all rows, click Select None.

Select columns in the log

- ❖ Do one of the following:
 - Click a column header.
 - To select contiguous columns, click a column header and drag through additional columns, or click the first column header and then Shift-click the last column header.
 - To select noncontiguous columns, click the first column header and then Ctrl-click (Windows) or Command-click (Mac) additional column headers.

Reorder, resize, or sort columns in the log

- ❖ Do one of the following:
 - Drag selected columns to reorder them in the log. The column position is indicated by a double black line.
 - To resize a column, click the column header and then drag the separator.
 - To sort data in a column, click the column header to change the sort order, or right-click the header and choose Sort Ascending or Sort Descending. (Rows cannot be manually reordered.)

Delete rows or columns from the log

- 1 Select one or more rows or columns in the log.

2 Do one of the following:

- Choose Delete from the Measurement Log options menu.
- Click the Delete icon at the top of the panel.
- Right-click in a row or column header, then select Delete from the pop-up menu.

Export Measurement Log data

You can export data from the Measurement Log into a comma-delimited text file. You can open the text file in a spreadsheet application and perform statistical or analytical calculations from the measurement data.

1 Select one or more rows of data in the log.

2 Do one of the following:

- Choose Export from the Measurement Log options menu.
- Click the Export icon at the top of the panel.
- Right-click in a row, then select Export from the pop-up menu.

3 Enter a filename and location, and click Save.

The measurements are exported to a comma-delimited, UTF-8 text file.

Counting objects in an image (Photoshop Extended)

About counting (Photoshop Extended)

You can use the Count Tool to count objects in an image. To count objects manually, you click the image with the Count tool and Photoshop tracks the number of clicks. The count number is displayed on the item and in the Count Tool options bar. Count numbers are saved when you save a file.

Photoshop can also automatically count multiple selected areas in an image, and record the results in the Measurement Log panel.

See also

[“Performing a measurement \(Photoshop Extended\)”](#) on page 603

Manually count items in an image (Photoshop Extended)

1 Select the Count tool (located beneath the Eyedropper tool in the Tools panel).

2 Choose Count tool options.

Count Group A default count group is created when you add count numbers to the image. You can create multiple count groups, each with its own name, marker and label size, and color. When you add count numbers to the image, the currently selected count group is incremented. Click the eye icon to show or hide a count group. Click the folder icon to create a count group, the Delete icon to delete a count group. Choose Rename from the Count Group menu to rename a count group.

Color To set the color for the count group, click the Color Picker.

Marker Size Enter a value from 1 to 10, or use the scrubby slider to change the value.

Label Size Enter a value from 8 to 72, or use the scrubby slider to change the value.

3 Click in the image to add a count marker and label:

- To move a count marker, move the pointer over the marker or number until the cursor changes to the direction arrows, then drag. (Shift-click to constrain the drag horizontally or vertically.)
- Alt-click (Windows) or Option-click (Mac OS) to remove a marker. The total count is updated.
- Click Clear in the options bar to reset the count for the currently selected count group to 0.

Note: Counts already recorded in the Measurement Log are not changed by clearing count numbers from the image.

4 (Optional) To change count groups, select a different group from the Count Group menu, or click the folder icon to create a count group. Subsequent clicks update the currently selected count group.

5 (Optional) To display or hide the count numbers:

- Choose View > Show > Count.
- Choose View > Extras, View > Show > All, or View > Show > None.

6 (Optional) Choose Analysis > Record Measurements or click Record Measurements in the Measurement Log panel to record the count number to the Measurement Log.

Note: To record a count to the Measurement Log, you must have Count selected as a measurement data point. Choose Analysis > Select Data Points > Custom and select the Count data point in the Count Tool area.

7 (Optional) Choose File > Save to save any count numbers and count groups you've added to the image.

Automatic counting using a selection (Photoshop Extended)

Use the Photoshop automatic counting feature to count multiple selection areas in an image. Define selection areas using the Magic Wand tool or the Color Range command.

1 Select the Magic Wand tool, or choose Select > Color Range.

2 Create a selection that includes the objects in the image that you want to count. For best results, use an image with objects that contrast well against their background.

- If you are using the Magic Wand tool, increase or decrease the Tolerance option to optimize the selection of the objects you want to count in the image. Deselect the Anti-alias and Contiguous options.
- For Color Range, set Fuzziness and Selected Colors to fine-tune the selected areas in the image (see “[Select a color range](#)” on page 253).

3 Choose Analysis > Select Data Points > Custom.

4 In the Selections area, select the Count data point and click OK.

5 Choose Window > Measurement Log.

6 Choose Analysis > Record Measurements, or click Record Measurements in the Measurement Log. (If this option isn't available, select a tool other than the Count tool.)

Photoshop counts the selection areas and enters the number in the Count column in the Measurement Log.

See also

“[Select with the Magic Wand tool](#)” on page 253

Photoshop and MATLAB (Photoshop Extended)

About Photoshop and MATLAB (Photoshop Extended)

MATLAB is a high-level technical computing language and interactive environment for algorithm development, data visualization, data analysis, and numeric computation. With Photoshop Extended you can view MATLAB image-processing results in Photoshop, and combine MATLAB commands with Photoshop image-editing features.

Once you connect to Photoshop from MATLAB, typing commands into the MATLAB command prompt performs operations in Photoshop. You can run MATLAB algorithms and view the results in your image in Photoshop.

Note: Communication between Photoshop and MATLAB uses the Photoshop JavaScript interface and the MATLAB library interface.

Set up MATLAB and Photoshop (Photoshop Extended)

Install Photoshop and MATLAB on your computer. Once you have installed Photoshop Extended and MATLAB, you should verify the MATLAB integration.

Verify MATLAB integration

- 1 Start Photoshop Extended and then MATLAB.
- 2 From MATLAB, add the path Photoshop/MATLAB, including subfolders.
- 3 At the MATLAB prompt, open the MATLAB folder, locate and open the Tests folder, and then type **testall**.
- 4 Photoshop and MATLAB run a series of tests to ensure integration between the two programs and display a summary report.

(Optional) Set access to Photoshop from MATLAB

You can set up a path to Photoshop Extended to allow direct access to Photoshop commands from MATLAB.

- 1 From MATLAB, choose File > Set Path.
- 2 Click Add Folder and select the MATLAB folder where Photoshop Extended is installed.
- 3 Click Save and then Close.
- 4 From the MATLAB menu, choose File > Preferences.
- 5 In the Preferences dialog box, click the General tree (upper-left).
- 6 Click the Update Toolbox Path Cache button.
- 7 Click Apply and then OK.

Connect/disconnect to Photoshop from MATLAB (Photoshop Extended)

- ❖ In MATLAB, do one of the following:
 - To launch or connect to Photoshop, type **pslaunch**, and then press Enter (Windows) or Return (Mac OS).
 - To disconnect from Photoshop and quit, type **psquit** and press Enter (Windows) or Return (Mac OS).

Using help and getting started (Photoshop Extended)

MATLAB's help system includes examples of a MATLAB/Photoshop workflow.

1 Choose Help > Full Product Family Help.

You see a Photoshop Toolbox with submenu items, including Examples for getting started. If you don't see the Photoshop Toolbox, try the following steps.

2 Click the Start Button.

3 Choose Desktop Tools > View Source Files.

4 Click the Refresh Start button, then Close, then retry the Help menu.

MATLAB commands (Photoshop Extended)

Typing commands in the MATLAB command line lets you connect and disconnect to Photoshop, and generate pixels viewable in a Photoshop document.

For a list of all MATLAB Photoshop commands, browse the file `psfunctions.cat.html`, available in the MATLAB folder in the directory where you installed Photoshop. Enter **help** (command name) at the MATLAB command prompt for a fuller description of each command, including syntax, arguments, and examples.

Note: All MATLAB commands are supported for Japanese characters. MATLAB for Windows supports a Japanese language user interface on Japanese language Windows XP systems. MATLAB for Mac OS supports US English only on Japanese language Mac OS systems. For more information, contact The MathWorks, Inc.

Create a document in MATLAB (Photoshop Extended)

1 In MATLAB, enter `psnewdoc`.

2 To specify the attributes of the new document, enter one of the following:

- To create a document using the default values, enter `psnewdoc()`. For information on default values, see below.
- To create a document with a specific width and height, enter `psnewdoc(W,H)`. The W and H values use the current units set in the Units & Rulers option in the Photoshop Preferences dialog box. Other document attributes are set to their default values.

Note: Enter "undefined" as a string to skip input arguments. The default size for a new document is 504 x 360 pixels.

- To create a document and specify attributes, enter `psnewdoc(W,H,R,N,M,F,A,B,P)`. For information on new document attributes, see below.

Here is an example code for creating a document and specifying all the attributes in MATLAB:

```
psnewdoc(10, 10, 72, 'hi', 'cmyk', 'transparent', 2.5, 16, 'U.S. Web Coated (SWOP) v2')
```

New document attributes and defaults

Entering `psnewdoc(W,H,R,N,M,F,A,B,P)` creates a document with values for the following attributes:

W Specifies the width of the document using the current units from the Units & Rulers option in the Photoshop Preferences dialog box. The default width is 504 pixels.

H Specifies the height of the document using the current units in the Units & Rulers panel in the Photoshop Preference dialog box. The default height is 360.

R Specifies the resolution. The default is 72 ppi.

N Specifies the document name. The default is Untitled-X, where X is the index for new documents.

M Specifies the color mode: RGB, CMYK, Lab, Bitmap, or Grayscale. The default is RGB.

F Specifies the background contents of the new document: White, Background Color, or Transparent. The default is White.

A Specifies the pixel aspect ratio. The default is 1.0 (square).

B Specifies the bit depth: 1, 8, 16, or 32. The default is 8.

P Specifies the color profile. The default is the working color space for the specified color mode. The working spaces are specified in the Photoshop Color Settings dialog box.

Image Stacks (Photoshop Extended)

About image stacks (Photoshop Extended)

An image stack combines a group of images with a similar frame of reference, but differences of quality or content across the set. Once combined in a stack, you can process the multiple images to produce a composite view that eliminates unwanted content or noise.

You can use image stacks to enhance images in number of ways:

- To reduce image noise and distortion in forensic, medical, or astrophotographic images.
- To remove unwanted or accidental objects from a series of stationary photos or a series of video frames. For example, you want to remove a figure walking through an image, or remove a car passing in front of the main subject matter.

Image stacks are stored as Smart Objects. The processing options you can apply to the stack are called stack modes. Applying a stack mode to an image stack is a non-destructive edit. You can change stack modes to produce different effects; the original image information in the stack remains unchanged. To preserve changes after you apply the stack mode, save the result as a new image, or rasterize the Smart Object. You can create an image stack manually or using a script.

Creating an image stack (Photoshop Extended)

For best results, images contained in an image stack should have the same dimensions and mostly similar content, such as a set of still images taken from a fixed viewpoint, or a series of frames from a stationary video camera. The content of your images should be similar enough to allow you to register or align them to other images in the set.

1 Combine the separate images into one multi-layered image. See “[Duplicate layers](#)” on page 282.

Note: An image stack must contain at least two layers.

You can also combine images using a script (File > Scripts > Load Files into Stack).

2 Choose Select > All Layers.

Note: To make the Background layer selectable with the All Layers command, you must first convert it to a regular layer.

3 Choose Edit > Auto-Align Layers and select Auto as the alignment option. If Auto does not create good registration of your layers, try the Reposition option.

4 Choose Layer > Smart Objects > Convert to Smart Object.

5 Choose Layer > Smart Objects > Stack Mode and select a stack mode from the submenu.

- For noise reduction, use the Mean or Median plug-ins.

- For removing objects from the image, use the Median plug-in.

The output is a composite image the same size as the original image stack. You may need to experiment with different plug-ins to get the best enhancement for a particular image.

To change the rendering effect, choose a different Stack Mode from the submenu. Stack rendering is not cumulative—each render effect operates on the original image data in the stack and replaces previous effects.

Stack modes

Stack modes operate on a per-channel basis only, and only on non-transparent pixels. For example, the Maximum mode returns the maximum red, green, and blue channel values for a pixel cross section and merges them into one composite pixel value in the rendered image.

Rendering plug-in name	Result	Comments
Entropy	$\text{entropy} = - \sum (\text{probability of value}) * \log_2(\text{probability of value})$ $\text{Probability of value} = (\text{number of occurrences of value}) / (\text{total number of non-transparent pixels})$	The binary entropy (or zero order entropy) defines a lower bound on how many bits would be necessary to losslessly encode the information in a set.
Kurtosis	$\text{kurtosis} = (\sum (\text{value} - \text{mean})^4 \text{ over non-transparent pixels}) / ((\text{number of non-transparent pixels} - 1) * (\text{standard deviation})^4)$	A measure of peakedness or flatness compared to a normal distribution. The kurtosis for a standard normal distribution is 3.0. Kurtosis greater than 3 indicates a peaked distribution, and kurtosis less than 3 indicates a flat distribution (compared to a normal distribution).
Maximum	The maximum channel values for all non-transparent pixels	
Mean	The mean channel values for all non-transparent pixels	Effective for noise reduction
Median	The median channel values for all non-transparent pixels	Effective for noise reduction and removal of unwanted content from the image
Minimum	The minimum channel values for all non-transparent pixels	
Range	Maximum minus the minimum of the non-transparent pixel values	
Skewness	$\text{skewness} = (\sum (\text{value} - \text{mean})^3 \text{ over non-transparent pixels}) / ((\text{number of non-transparent pixels} - 1) * (\text{standard deviation})^3)$	Skewness is a measure of symmetry or asymmetry around the statistical mean
Standard Deviation	standard deviation = Square Root(variance)	
Summation	The sum channel values for all non-transparent pixels	
Variance	$\text{variance} = (\sum (\text{value} - \text{mean})^2 \text{ over non-transparent pixels}) / (\text{number of non-transparent pixels} - 1)$	

Remove stack rendering

- ❖ Choose Layers > Smart Objects > Stack Mode > None to remove any rendering from an image stack and convert it back to a regular Smart Object.

Edit an image stack

Because an image stack is a Smart Object, you can edit the original images that make up the stack layers at any time.

- ❖ Choose Layer > Smart Objects > Edit Contents, or double-click the layer thumbnail. After you save the edited Smart Object, the stack is automatically rendered with the last rendering option applied to the stack.

Convert an image stack

To preserve rendering effects on an image stack, convert the Smart Object to a regular layer. (You can copy the Smart Object before converting, in case you want to later re-render the image stack.)

- ❖ Choose Layer > Smart Objects > Rasterize.

Use a script to create an image stack (Photoshop Extended)

You can use the Statistics script to automate creating and rendering an image stack.

- 1 Choose File > Scripts > Statistics.
- 2 Choose a stack mode from the Choose Stack Mode menu.
- 3 Apply the stack mode to currently open files, or browse to select a folder or individual files.

Files you select are listed in the dialog box.

- 4 If desired, select Attempt To Automatically Align Source Images (equivalent to choosing Edit > Auto-Align Layers). Then click OK.

Photoshop combines the multiple images into a single multilayered image, converts the layers into a Smart Object, and applies the selected stack mode.

Chapter 20: Automating tasks

Automating tasks can save you time and ensure consistent results for many types of operations. Photoshop provides a variety of ways to automate tasks—using actions, droplets, the Batch command, scripting, templates, variables, and data sets.

Automating with actions

About actions

An *action* is a series of tasks that you play back on a single file or a batch of files—menu commands, panel options, tool actions, and so on. For example, you can create an action that changes the size of an image, applies an effect to the image, and then saves the file in the desired format.

Actions can include steps that let you perform tasks that cannot be recorded (for example, using a painting tool). Actions can also include modal controls that let you enter values in a dialog box while playing an action.

In Photoshop, actions are the basis for *droplets*, which are small applications that automatically process all files that are dragged onto their icon.

Photoshop and Illustrator come with predefined actions installed that help you perform common tasks. You can use these actions as is, customize them to meet your needs, or create new actions. Actions are stored in sets to help you organize them.

You can record, edit, customize, and batch-process actions, and you can manage groups of actions by working with action sets.

Actions panel overview

You use the Actions panel (Window > Actions) to record, play, edit, and delete individual actions. This panel also lets you save and load action files.

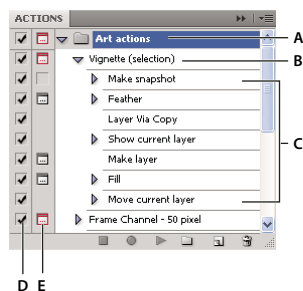

Photoshop Actions panel

A. Action set B. Action C. Recorded commands D. Included command E. Modal control (toggles on or off)

Expand and collapse sets, actions, and commands

- ❖ Click the triangle to the left of the set, action, or command in the Actions panel. Alt-click (Windows) or Option-click (Mac OS) the triangle to expand or collapse all actions in a set or all commands in an action.

View actions by name only

- ❖ Choose Button Mode from the Actions panel menu. Choose Button Mode again to return to list mode.

Note: You can't view individual commands or sets in Button mode.

Select actions in the Actions panel

- ❖ Click an action name. Shift-click action names to select multiple, contiguous actions, and Ctrl-click (Windows) or Command-click (Mac OS) action names to select multiple, discontinuous actions.

Play an action on a file

Playing an action executes the action's recorded commands in the active document. (Some actions require that you make a selection before playing; some can be executed on an entire file.) You can exclude specific commands from an action or play only a single command. If the action includes a modal control, you can specify values in a dialog box or use a modal tool when the action pauses.

Note: In Button mode, clicking a button executes the entire action—although commands previously excluded are not executed.

- 1 If necessary, select objects on which to play the action, or open a file.
- 2 Do one of the following:
 - (Illustrator) To play a set of actions, select the set name, and click the Play button  in the Actions panel, or choose Play from the panel menu.
 - To play an entire single action, select the action name, and click the Play button in the Actions panel, or choose Play from the panel menu.
 - If you assigned a key combination to the action, press that combination to play the action automatically.
 - To play only a part of an action, select the command from which you want to start playing, and click the Play button in the Actions panel, or choose Play from the panel menu.
 - To play a single command, select the command, and then Ctrl-click (Windows) or Command-click (Mac OS) the Play button in the Actions panel. You can also press Ctrl (Windows) or Command (Mac OS), and double-click the command.

 *In Photoshop, to undo an action, take a snapshot in the History panel before you play an action, and then select the snapshot to undo the action.*

Specify playback speed

You can adjust an action's playback speed or pause it to help you debug an action.

- 1 Choose Playback Options from the Actions panel menu.
- 2 Specify a speed, and click OK:

Accelerated Plays the action at normal speed (the default).

Note: When you play an action at accelerated speed, the screen may not update as the action executes—files may be opened, modified, saved, and closed without ever appearing on-screen, enabling the action to execute more quickly. If you want to see the files on-screen as the action executes, specify the Step By Step speed instead.

Step By Step Completes each command and redraws the image before going on to the next command in the action.

Pause For __ Seconds Specifies the amount of time the application should pause between carrying out each command in the action.

Manage actions

Manage actions in the Actions panel to keep them organized and to make available only the actions you need for a project. You can rearrange, duplicate, delete, rename, and change options for actions in the Actions panel.

Rearrange actions in the Actions panel

- ❖ In the Actions panel, drag the action to its new location before or after another action. When the highlighted line appears in the desired position, release the mouse button.

Duplicate actions, commands, or sets

- ❖ Do one of the following:
 - Alt-drag (Windows) or Option-drag (Mac OS) the action or command to a new location in the Actions panel. When the highlighted line appears in the desired location, release the mouse button.
 - Select an action or command. Then choose Duplicate from the Actions panel menu.
 - Drag an action or command to the Create New Action button at the bottom of the Actions panel.

You can duplicate sets with any of the same methods.

Delete actions, commands, or sets

- 1 In the Actions panel, select the action, command, or set.
- 2 Do any of the following:
 - Click the Delete icon  on the Actions panel. Click OK to complete the deletion.
 - Alt-click (Windows) or Option-click (Mac OS) the Delete icon to delete the selection without displaying a confirmation dialog box.
 - Drag the selection to the Delete icon on the Actions panel to delete without displaying a confirmation dialog box.
 - Choose Delete from the Actions panel menu.

Delete all actions in the Actions panel

- ❖ Choose Clear All Actions (Photoshop) or Clear Actions (Illustrator) from the Actions panel menu.

Even after clearing all actions, the Actions panel can be restored to its default set of actions.

Rename an action or change options

- 1 Select the action, and choose Action Options from the Actions panel menu.
- 2 Type a new name for the action, or change the options for its set, function key combination, or button color.
- 3 Click OK.

 *Double-clicking the action name in the Actions panel in Illustrator also opens the Action Options dialog box. In Photoshop, you can double-click an action in the Actions panel and enter a new name directly in the Actions panel.*

Manage action sets

You can create and organize sets of task-related actions that can be saved to disk and transferred to other computers.

Note: Any actions that you create are automatically listed in the Actions panel, but to truly save an action and not risk losing it if you delete your preferences file (Illustrator) or Actions panel file (Photoshop), you have to save it as part of an action set.

Save a set of actions

- 1 Select a set.

 *If you want to save a single action, first create an action set and move the action to the new set.*

- 2 Choose Save Actions from the Actions panel menu.
- 3 Type a name for the set, choose a location, and click Save.

You can save the file anywhere. You can save only the entire contents of a set in the Actions panel, not individual actions.

Note: (Photoshop only) *If you place the saved action-set file in the Presets/Actions folder, the set will appear at the bottom of the Actions panel menu after you restart the application.*

 (Photoshop only) *Press Ctrl+Alt (Windows) or Command+Option (Mac OS) when you choose the Save Actions command to save the actions in a text file. You can use this file to review or print the contents of an action. However, you can't reload the text file back into Photoshop.*

Load a set of actions

By default, the Actions panel displays predefined actions (shipped with the application) and any actions you create. You can also load additional actions into the Actions panel.

❖ Do one of the following:

- Choose Load Actions from the Actions panel menu. Locate and select the action set file, and then click Load (Photoshop) or Open (Illustrator).
- (Photoshop only) Select an action set from the bottom of the Actions panel menu.

Photoshop action set files have the extension .atn; Illustrator action set files have the extension .aia.

Restore actions to the default set

- 1 Choose Reset Actions from the Actions panel menu.
- 2 Click OK to replace the current actions in the Actions panel with the default set, or click Append to add the set of default actions to the current actions in the Actions panel.

Organize action sets

To help you organize your actions, you can create sets of actions and save the sets to disk. You can organize sets of actions for different types of work—such as print publishing and online publishing—and transfer sets to other computers.

- To create a new set of actions, click the Create New Set button  in the Actions panel or choose New Set from the panel menu. Then enter the name of the set, and click OK.

Note: *If you plan to create a new action and group it in a new set, make sure you create the set first. Then, the new set will appear in the set popup menu when you create your new action.*

- To move an action to a different set, drag the action to that set. When the highlighted line appears in the desired position, release the mouse button.
- To rename a set of actions, double-click the name of the set in the Actions panel or choose Set Options from the Actions panel menu. Then enter the new name of the set, and click OK.
- To replace all actions in the Actions panel with a new set, choose Replace Actions from the Actions panel menu. Select an actions file, and click Load (Photoshop) or Open (Illustrator).

Important: The Replace Actions command replaces all sets of actions in the current document. Before using the command, make sure that you have already saved a copy of your current set of actions using the Save Actions command.

Creating actions

Recording actions

Keep in mind the following guidelines when recording actions:

- You can record most—but not all—commands in an action.
- You can record operations that you perform with the Marquee, Move, Polygon, Lasso, Magic Wand, Crop, Slice, Magic Eraser, Gradient, Paint Bucket, Type, Shape, Notes, Eyedropper, and Color Sampler tools—as well as those that you perform in the History, Swatches, Color, Paths, Channels, Layers, Styles, and Actions panels.
- Results depend on file and program setting variables, such as the active layer and the foreground color. For example, a 3-pixel Gaussian blur won't create the same effect on a 72-ppi file as on a 144-ppi file. Nor will Color Balance work on a grayscale file.
- When you record actions that include specifying settings in dialog boxes and panels, the action will reflect the settings in effect at the time of the recording. If you change a setting in a dialog box or panel while recording an action, the changed value is recorded.

Note: Most dialog boxes retain the settings specified at the previous use. Check carefully that those are the values you want to record.

- Modal operations and tools—as well as tools that record position—use the units currently specified for the ruler. A modal operation or tool is one that requires you to press Enter or Return to apply its effect, such as transforming or cropping. Tools that record position include the Marquee, Slice, Gradient, Magic Wand, Lasso, Shape, Path, Eyedropper, and Notes tools.

 If you record an action that will be played on files of different sizes, set the ruler units to percentages. As a result, the action will always play back in the same relative position in the image.

- You can record the Play command listed on the Actions panel menu to cause one action to play another.

Recording actions works similarly in Photoshop and Illustrator.

Record an action

When you create a new action, the commands and tools you use are added to the action until you stop recording.

 To guard against mistakes, work in a copy: at the beginning of the action before applying other commands, record the File > Save A Copy command (Illustrator) or record the File > Save As command and select As A Copy (Photoshop). Alternatively, in Photoshop you can click the New Snapshot button on the History panel to make a snapshot of the image before recording the action.

- 1 Open a file.
- 2 In the Actions panel, click the Create New Action button , or choose New Action from the Actions panel menu.
- 3 Enter an action name, select an action set, and set additional options:

Function Key Assigns a keyboard shortcut to the action. You can choose any combination of a function key, the Ctrl key (Windows) or Command key (Mac OS), and the Shift key (for example, Ctrl+Shift+F3), with these exceptions: In Windows, you cannot use the F1 key, nor can you use F4 or F6 with the Ctrl key.

Note: If you assign an action the same shortcut that is used for a command, the shortcut will apply the action rather than the command.

Color Assigns a color for display in Button mode.

4 Click Begin Recording. The Begin Recording button in the Actions panel turns red .

Important: When recording the Save As command, do not change the filename. If you enter a new filename, that new name is recorded and used each time you run the action. Before saving, if you navigate to a different folder, you can specify a different location without having to specify a filename.

5 Perform the operations and commands you want to record.

Not all tasks in actions can be recorded directly; however, you can insert most nonrecordable tasks using commands in the Actions panel menu.

6 To stop recording, either click the Stop Playing/Recording button, or choose Stop Recording from the Actions panel menu. (In Photoshop, you can also press the Esc key.)

 To resume recording in the same action, choose Start Recording from the Actions panel menu.

Record a path

The Insert Path command lets you include a complex path (a path created with a pen tool or pasted from Adobe Illustrator) as part of an action. When the action is played back, the work path is set to the recorded path. You can insert a path when recording an action or after it has been recorded.

1 Do one of the following:

- Start recording an action.
- Select an action's name to record a path at the end of the action.
- Select a command to record a path after the command.

2 Select an existing path from the Paths panel.

3 Choose Insert Path from the Actions panel menu.

If you record multiple Insert Path commands in a single action, each path replaces the previous one in the target file. To add multiple paths, record a Save Path command using the Paths panel after recording each Insert Path command.

Note: Playing actions that insert complex paths may require significant amounts of memory. If you encounter problems, increase the amount of memory available to Photoshop.

Insert a stop

You can include stops in an action that let you perform a task that cannot be recorded (for example, using a painting tool). After you complete the task, click the Play button in the Actions panel to complete the action.

You can also display a short message when the action reaches the stop as a reminder of what needs to be done before continuing with the action. You can include a Continue button in the message box in case no other task needs to be done.

1 Choose where to insert the stop by doing one of the following:

- Select an action's name to insert a stop at the end of the action.
- Select a command to insert a stop after the command.



2 Choose Insert Stop from the Actions panel menu.

- 3 Type the message you want to appear.
- 4 If you want the option to continue the action without stopping, select Allow Continue.
- 5 Click OK.

 You can insert a stop when recording an action or after it has been recorded.

Change settings when playing an action

By default, actions are completed using the values specified when they were originally recorded. If you want to change the settings for a command within an action, you can insert a *modal control*. A modal control pauses an action so that you can specify values in a dialog box or use a modal tool. (A modal tool requires pressing Enter or Return to apply its effect—once you press Enter or Return, the action resumes its tasks.)

A modal control is indicated by a dialog box icon  to the left of a command, action, or set in the Actions panel. A red dialog box icon  indicates an action or set in which some, but not all, commands are modal. You can't set a modal control in Button mode.

- ❖ Do one of the following:
 - To enable a modal control for a command within an action, click the box to the left of the command name. Click again to disable the modal control.
 - To enable or disable modal controls for all commands in an action, click the box to the left of the action name.
 - To enable or disable modal controls for all actions in a set, click the box to the left of the set name.

Exclude commands from an action

You can exclude commands that you don't want to play as part of a recorded action. You can't exclude commands in Button mode.

- 1 If necessary, expand the listing of commands in the action by clicking the triangle to the left of the action name in the Actions panel.
- 2 Do one of the following:
 - To exclude a single command, click to clear the check mark to the left of the command name. Click again to include the command.
 - To exclude or include all commands or actions in an action or set, click the check mark to the left of the action or set name.
 - To exclude or include all commands *except* the selected command, Alt-click (Windows) or Option-click (Mac OS) its check mark.

To indicate that some of the commands within the action are excluded, in Photoshop the check mark of the parent action turns red; in Illustrator the check mark of the parent action becomes dimmed.

Insert a non-recordable menu command

You cannot record the painting and toning tools, tool options, View commands, and Window commands. However, you can insert many non-recordable commands into an action using the Insert Menu Item command.

You can insert a command when recording an action, or after it has been recorded. An inserted command doesn't execute until the action is played, so the file remains unchanged when the command is inserted. No values for the command are recorded in the action. If the command opens a dialog box, the dialog box appears during playback, and the action pauses until you click OK or Cancel.

Note: When you use the *Insert Menu Item* command to insert a command that opens a dialog box, you cannot disable the modal control in the Actions panel.

- 1 Choose where to insert the menu item:
 - Select an action's name to insert the item at the end of the action.
 - Select a command to insert the item at the end of the command.
- 2 Choose *Insert Menu Item* from the Actions panel menu.
- 3 With the *Insert Menu Item* dialog box open, choose a command from its menu.
- 4 Click OK.

Edit and rerecord actions

It is easy to edit and customize actions. You can tweak the settings of any specific command within an action, add commands to an existing action, or step through an entire action and change any or all settings.

Overwrite a single command

- 1 In the Actions panel, double-click the command.
- 2 Enter the new values, and click OK.

Add commands to an action

- 1 Do one of the following:
 - Select the action name to insert a new command at the end of the action.
 - Select a command in the action to insert a command after it.
- 2 Click the *Begin Recording* button, or choose *Start Recording* from the Actions panel menu.
- 3 Record the additional commands.
- 4 When finished, click the *Stop Playing/Recording* button in the Actions panel or choose *Stop Recording* from the panel menu.

Rearrange commands within an action

- ❖ In the Actions panel, drag a command to its new location within the same or another action. When the highlighted line appears in the desired position, release the mouse button.

Record an action again

- 1 Select an action, and choose *Record Again* from the Actions panel menu.
- 2 If a modal tool appears, use the tool to create a different result, and press Enter or Return, or just press Enter or Return to retain the same settings.
- 3 If a dialog box appears, change the settings, and click OK to record them, or click Cancel to retain the same values.

Processing a batch of files

Convert files with the Image Processor

The Image Processor converts and processes multiple files. Unlike the Batch command, the Image Processor lets you process files without first creating an action. You can do any of the following in the Image Processor:

- Convert a set of files to either JPEG, PSD, or TIFF format; or convert files simultaneously to all three formats.
- Process a set of camera raw files using the same options.
- Resize images to fit within specified pixel dimensions.
- Embed a color profile or convert a set of files to sRGB and save them as JPEG images for the web.
- Include copyright metadata into the converted images.

The Image Processor works with Photoshop (PSD), JPEG, and camera raw files.

1 Do any of the following:

- Choose File > Scripts > Image Processor (Photoshop)
- Choose Tools > Photoshop > Image Processor (Bridge)

2 Select the images you want to process. You can choose to process any open files, or select a folder of files to process.

3 (Optional) Select Open First Image To Apply Settings to apply the same settings to all the images.

If you are processing a group of camera raw files taken under the same lighting conditions, you can adjust the setting in the first image to your satisfaction and then apply the same settings to the remaining images.

Use this option with PSD or JPEG source images if the file's color profile does not match your working profile. You can choose a color profile in which to convert the first image and all images in the folder.

***Note:** The settings you apply with the Image Processor are temporary and used only with the Image Processor. The image's current camera raw settings are used to process the image, unless you change them in the Image Processor.*

4 Select the location where you want to save the processed files.

If you process the same file multiple times to the same destination, each file is saved with its own file name and not overwritten.

5 Select the file types and options to save.

Save As JPEG Saves images in JPEG format within a folder called JPEG in the destination folder.

Quality Sets the JPEG image quality between 0 and 12.

Resize To Fit Resizes the image to fit within the dimensions you enter in Width and Height. The image retains its original proportions.

Convert Profile To sRGB Converts the color profile to sRGB. Make sure that Include ICC Profile is selected if you want to save the profile with the image.

Save As PSD Saves images in Photoshop format within a folder called PSD in the destination folder.

Maximize Compatibility Saves a composite version of a layered image within the target file for compatibility with applications that can't read layered images.

Save As TIFF Saves images in TIFF format within a folder called TIFF in the destination folder.

LZW Compression Saves the TIFF file using the LZW compression scheme.

6 Set other processing options.

Run Action Runs a Photoshop action. Choose the action set from the first menu and the action from the second menu. The action set must be loaded in the Actions panel before they appear in these menus.

Copyright Info Includes any text you enter in the IPTC copyright metadata for the file. Text you include here overwrites the copyright metadata in the original file.

Include ICC Profile Embeds the color profile with the saved files.

7 Click Run.

 Before you process your images, click Save to save the current settings in the dialog box. The next time you need to process files using this group of settings, click Load, and navigate to your saved Image Processor settings.

Process a batch of files

The Batch command runs an action on a folder of files. If you have a digital camera or a scanner with a document feeder, you can also import and process multiple images with a single action. Your scanner or digital camera may need an *acquire* plug-in module that supports actions.

Note: If the third-party plug-in wasn't written to import multiple documents at a time, it may not work during batch-processing or if used as part of an action. Contact the plug-in's manufacturer for further information.

You can also import PDF images from Acrobat Capture or other software.

When batch-processing files, you can leave all the files open, close and save the changes to the original files, or save modified versions of the files to a new location (leaving the originals unchanged). If you are saving the processed files to a new location, you may want to create a new folder for the processed files before starting the batch.

To batch-process using multiple actions, create a new action that plays all the other actions, and then batch-process using the new action. To batch-process multiple folders, create aliases within a folder to the other folders you want to process, and select the Include All Subfolders option.

 For better batch performance, reduce the number of saved history states and deselect the Automatically Create First Snapshot option in the History panel.

Batch-process files

1 Do one of the following:

- Choose File > Automate > Batch (Photoshop)
- Choose Tools > Photoshop > Batch (Bridge)

2 Specify the action you want to use to process files from the Set and Action pop-up menus. The menus display actions available in the Actions panel. You may need to choose a different set or load a set in the panel if you don't see your action.

3 Choose the files to process from the Source pop-up menu:

Folder Processes files in a folder you specify. Click Choose to locate and select the folder.

Import Processes images from a digital camera, scanner, or a PDF document.

Opened Files Processes all open files.

Bridge Processes selected files in Adobe Bridge. If no files are selected, the files in the current Bridge folder are processed.

4 Set processing, saving, and file naming options. For descriptions of the Batch dialog box settings see “[Batch and droplet processing options](#)” on page 625.

Batch-process files in nested folders into different formats

- 1 Process your folders as you would normally, until the Destination step.
- 2 Choose Save And Close for the destination. You can specify options for Override Action “Save As” Commands to do the following:
 - If the “Save As” step in the action contains a file name, this name is overridden by the name of the document being saved; all “Save As” steps are treated as if they were recorded without a file name.
 - The folder you specified in the “Save As” action step is overridden by the document’s original folder.

Note: You must have a “Save As” step in the action; the Batch command does not automatically save files.

You can use this procedure, for example, to sharpen, resize, and save images as JPEGs in their original folders. You create an action that has a sharpen step, a resize step, and then a “Save As JPEG” step. When you batch-process this action, you select Include All Subfolders, make the destination Save And Close, and select Override Action “Save As” Commands.

Create a droplet from an action

A *droplet* applies an action to one or more images, or a folder of images, that you drag onto the Droplet icon. You can save a droplet on the desktop or to another location on disk.



Droplet icon

Actions are the basis for creating droplets—you must create the desired action in the Actions panel before creating a droplet. (See “[Recording actions](#)” on page 618.)

- 1 Choose File > Automate > Create Droplet.
- 2 Specify where to save the droplet. Click Choose in the Save Droplet In section of the dialog box and navigate to the location.
- 3 Select the Action Set, and then designate which action you intend to use within the Set and Action menus. (Select the action in the Actions panel before you open the dialog box to preselect these menus.)
- 4 Set processing, saving, and file naming options. For descriptions of the Batch dialog box settings see “[Batch and droplet processing options](#)” on page 625.

Tips for cross-platform droplets

When creating droplets for both Windows and Mac OS, keep the following compatibility issues in mind:

- After moving a droplet created in Windows to Mac OS, you must drag the droplet onto the Photoshop icon on your desktop. Photoshop updates the droplet for use in Mac OS.
- When creating a droplet in Mac OS, use the .exe extension to make droplets compatible with both Windows and Mac OS.
- References to file names are not supported between operating systems. If an action step references a file or folder name (such as an Open command, Save As command, or adjustment command that loads its settings from a file), execution pauses and the user is prompted for a file name.

Process a file with a droplet

- ❖ Drag a file or folder onto the droplet icon. Photoshop starts if it is not already running.

Batch and droplet processing options

Specify these options in the Batch and Droplet dialog boxes.

Override Action “Open” Commands Ensures that the files you selected in the Batch command are processed, without opening the file you may have specified in the action's Open command. If the action contains an Open command that opens a saved file and you don't select this option, the Batch command opens and processes only the file you used to record the Open command (This occurs because the Batch command opens the file specified by the action after each of the files in the Batch source folder is opened. Because the most recently opened file is the one named in the action, the Batch command performs the action on that file, and none of the files in the Batch source folder are processed.)

To use this option, the action must contain an Open command. Otherwise, the Batch command won't open the files you've selected for batch-processing. Selecting this option doesn't disregard everything in an Open command—only the choice of files to open.

Deselect this option if the action was recorded to operate on an open file, or if the action contains Open commands for specific files that are required by the action.

Include All Subfolders Processes files in subdirectories of the specified folder.

Suppress Color Profile Warnings Turns off display of color policy messages.

Suppress File Open Options Dialogs Hides File Open Options dialog boxes. This is useful when batching actions on camera raw image files. The default or previously specified settings will be used.

Destination menu Sets where to save the processed files

- **None** Leaves the files open without saving changes (unless the action includes a Save command).
- **Save And Close** Saves the files in their current location, overwriting the original files.
- **Folder** Saves the processed files to another location. Click Choose to specify the destination folder.

Override Action “Save As” Commands Ensures that processed files are saved to the destination folder specified in the Batch command (or to their original folder if you chose Save and Close), with their original names or the names you specified in the File Naming section of the Batch dialog box.

If you don't select this option and your action includes a Save As command, your files will be saved into the folder specified by the Save As command in the action, instead of the folder specified in the Batch command. In addition, if you don't select this option and the Save As command in the action specifies a filename, the Batch command overwrites the same file (the file specified in the action) each time it processes an image.

 *If you want the Batch command to process files using the original filenames in the folder you specified in the Batch command, save your image in the action. Then, when you create the batch, select Override Action “Save As” Command and specify a destination folder. If you rename the images in the Batch command and don't select Override Action “Save As” Command, Photoshop saves your processed images twice: once with the new name in the specified folder, and once with the original name in the folder specified by the Save As command in the action.*

To use this option, the action must contain a Save As command. Otherwise, the Batch command won't save the processed files. Selecting this option doesn't skip everything in the Save As command—only the specified filename and folder.

Note: *Some Save options aren't available in the Batch or Create Droplet commands (such as JPEG compression or TIFF options). To use these options, record a Save As step in the action that contains the desired options, and then use the Override Action “Save As” Commands option to make sure that your files are saved where you specify in the Batch or Create Droplet command. Photoshop disregards the specified filename and path in the Action's Save As command, and retains the Save options using the new path and filename you specify in the Batch dialog.*

File Naming Specifies file naming conventions if writing files to a new folder. Select elements from the pop-up menus or enter text into the fields to be combined into the default names for all files. The fields let you change the order and formatting of the components of the filename. You must include at least one field that is unique for every file (for example, filename, serial number, or serial letter) to prevent files from overwriting each other. Starting Serial Number specifies the starting number for any serial number fields. Serial letter fields always start with the letter “A” for the first file.

Compatibility Makes filenames compatible with Windows, Mac OS, and UNIX operating systems.

 *Saving files using the Batch command options usually saves the files in the same format as the original files. To create a batch process that saves files in a new format, record the Save As command followed by the Close command as part of your original action. Then choose Override Action “Save As” Commands for the Destination when setting up the batch process.*

Error menu Specifies how to handle processing errors:

- **Stop For Errors** Suspends the process until you confirm the error message.
- **Log Errors to File** Records each error in a file without stopping the process. If errors are logged to a file, a message appears after processing. To review the error file, open with a text editor after the Batch command has run.

See also

[Image processing video](#)

Scripting

About scripting

Photoshop supports external automation through scripting. In Windows, you can use scripting languages that support COM automation, such as VB Script. In Mac OS, you can use languages such as AppleScript that allow you to send Apple events. These languages are not cross-platform but can control multiple applications such as Adobe Photoshop, Adobe Illustrator, and Microsoft Office. In Mac OS, you can also use Apple’s Photoshop Actions for Automator to control tasks in Photoshop.

You can also use JavaScript on either platform. JavaScript support lets you write Photoshop scripts that run on either Windows or Mac OS.

***Note:** Refer to the scripting documentation included with your Photoshop application installation: [Photoshop CS4 AppleScript Ref.pdf](#), [Photoshop CS4 JavaScript Ref.pdf](#), [Photoshop CS4 Scripting Guide.pdf](#), and [Photoshop CS4 VBScript Ref.pdf](#). These guides can be found in [Photoshop CS4/Scripting Guide](#). The [Scripting Guide](#) can be found at [Application Folder > Scripting > Documents](#). The [Scriptlistener Plug-In](#) can be found at [Application Folder > Scripting > Utilities](#).*

Run a JavaScript

- ❖ Choose File > Scripts and then select the script from the list. The scripts list includes all the script files saved with a .js or .jsx extension and saved in the Photoshop CS4/Presets/Scripts folder. To run a script saved in another location, choose File > Scripts > Browse and navigate to the script.

Set scripts and actions to run automatically

You can have an event, such as opening, saving, or exporting a file in Photoshop, trigger a JavaScript or a Photoshop action. Photoshop provides several default events, or you can have any scriptable Photoshop event trigger the script or action. See the Photoshop CS4 Scripting Guide for more information on scriptable events.

- 1 Choose File > Scripts > Script Events Manager.
- 2 Select Enable Events To Run Scripts/Actions.
- 3 From the Photoshop Event menu, choose the event that will trigger the script or action.
- 4 Select either Script or Action, and then choose the script or action to run when the event occurs.

Photoshop has several sample scripts you can choose. To run a different script, choose Browse and then navigate to the script. For actions, choose the action set from the first pop-up menu and an action from that set in the second menu. The action must be loaded in the Actions panel to appear in these menus.

- 5 Click Add. The event and its associated script or action are listed in the dialog box.
- 6 To disable and remove individual events, select the event in the list and click Remove. To disable all events, but keep them in the list, deselect Enable Events To Run Scripts/Actions.

Creating data-driven graphics

About data-driven graphics

Data-driven graphics make it possible to produce multiple versions of an image quickly and accurately for print or web projects. For example, you can produce 100 versions of a web banner with different text and images, all based on a template design.

You generate the graphics by exporting them from Photoshop, or you can create templates for use in other programs such as Adobe® GoLive® or Adobe® Graphics Server (see “[Saving templates for use with other Adobe products](#)” on page 632).

Follow these general steps to create graphics from templates and data sets:

1. Create the base graphic to use as the template.

Use layers to separate the elements that you want to change in the graphic.

2. Define variables in the graphic.

Variables specify the parts of the image that change. (See “[Define variables](#)” on page 628.)

3. Create or import the data sets.

You can create the data sets in the template, or import them from a text file. (See “[Define a data set](#)” on page 629 and “[Creating data sets in external files](#)” on page 630.)

4. Preview the document with each data set.

To see how your final graphics will look, you can preview before you export all the files. (See “[Preview or apply a data set](#)” on page 630.)

5. Generate your graphics by exporting them with the data.

You can export them as Photoshop (PSD) files. (See “[Generate graphics using data sets](#)” on page 630.)

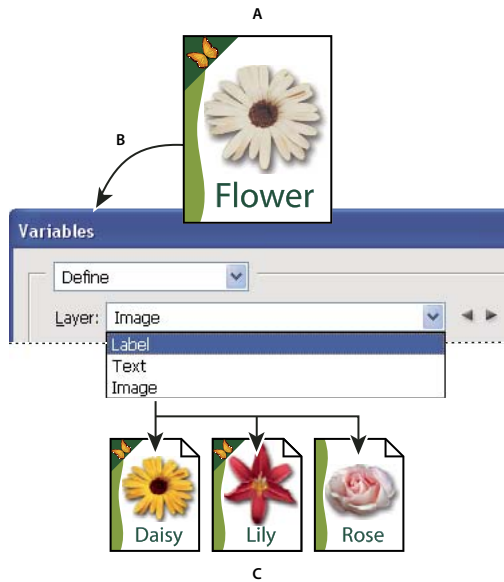

Creating different versions of an image using variables

A. Source file template B. User defines layers as variables. C. Different versions of the image can be created, each with a different variable data set.

Define variables

You use variables to define which elements in a template change. You can define three types of variables. Visibility variables show or hide the content of a layer. Pixel Replacement variables replace the pixels in the layer with pixels from another image file. Text Replacement variables replace a string of text in a type layer.

Note: GoLive recognizes all text and visibility variables, but not Pixel Replacement variables.

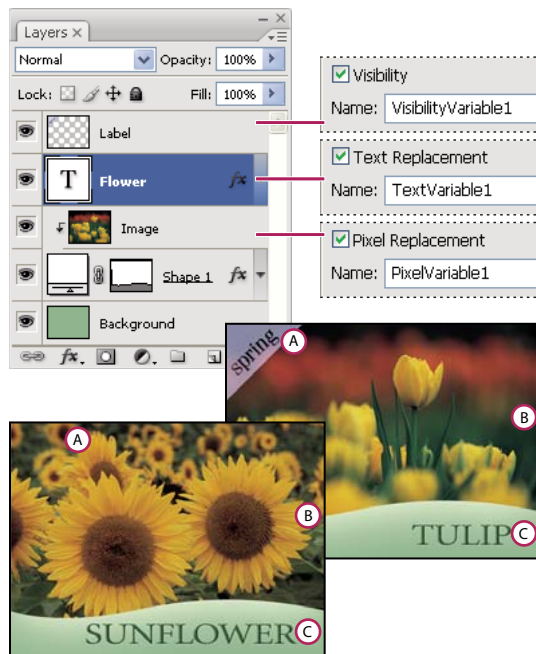

Two versions of an image based on the same template

A. Visibility variable B. Pixel Replacement variable C. Text Replacement variable

You cannot define variables for the Background layer.

- 1 Choose Image > Variables > Define.
- 2 Select a layer from the Layer pop-up menu that contains the content you want to define as a variable.
- 3 Select one or more types of variables:

Visibility Shows or hides the content of the layer.

Pixel Replacement Replaces the pixels in the layer with pixels from another image file.

Text Replacement Replaces a string of text in a type layer.

- 4 Do one of the following:
 - Choose Name and enter a name for the variable. Variable names must begin with a letter, underscore, or colon and cannot contain spaces or special characters (except for periods, hyphens, underscores, and colons).
 - Choose an existing variable from the Name pop-up menu to link this layer to. Layers linked to the same variable are shown next to the Name menu, along with the link icon.
- 5 For Pixel Replacement variables, set the following options.
 - Choose a method for scaling the replacement image: Fit scales the image so that it fits in the bounding box (which may leave parts of the bounding box empty), Fill scales the image so that it fills the bounding box entirely (which may cause the image to extend beyond the bounding box), As Is applies no scaling to the image, and Conform scales the image non-proportionally so that it fits in the bounding box.
 - Click a handle on the alignment icon  to choose an alignment for placing the image inside the bounding box. (This option is not available for Conform.)
 - Select Clip To Bounding Box to clip areas of the image that do not fit in the bounding box. This option is available only when the Fill or As Is replacement method is selected. (This option is not available for Conform.)
- 6 To define variables for another layer, choose a layer from the Layer pop-up menu. An asterisk appears next to the name of a layer that contains variables. You can use the navigation arrows to move between layers.
- 7 Click OK.

Rename a variable



- 1 Choose Image > Variables > Define.
- 2 Choose the layer that contains the variable from the Layer pop-up menu.
- 3 To rename the variable, enter a name in the Name text box. Variable names must begin with a letter, underscore, or colon and cannot contain spaces or special characters (except for periods, hyphens, underscores, and colons).
- 4 To remove the variable, deselect it.

Define a data set

A *data set* is a collection of variables and associated data. You define a data set for each version of the graphic that you want to generate.

- 1 Do one of the following:
 - Choose Image > Variables > Data Sets.
 - If the Variables dialog box is open, choose Data Sets from the pop-up menu at the top of the dialog box, or click Next.

Note: You must define at least one variable before you can edit the default data set.

- 2 Click the New Data Set button .
- 3 Select a variable from the Name pop-up menu or the list at the bottom of the dialog box.
- 4 Edit the variable data:
 - For Visibility variables , select Visible to show the layer's content or Invisible to hide the layer's content.
 - For Pixel Replacement variables , click Select File and select a replacement image file. Click Do Not Replace before the data set is applied to leave the layer in its current state.

Note: Do Not Replace does not reset the file to its original state if another replacement has been applied previously.

- For Text Replacement variables , enter a text string in the Value text box.

- 5 Define additional data sets for each version of the graphic you want to generate.

You can edit, rename, or delete the data set later by first choosing it from the Data Set pop-up menu and editing its options. Use the arrow icons to move between data sets. Click the Delete icon to delete a data set.

Preview or apply a data set

You can apply a data set's contents to the base image while leaving all the variables and data sets intact. This changes the look of the PSD document to contain the values of the data set. You can also preview how each version of your graphic will look with each data set.

Note: Applying a data set overwrites your original document.

- ❖ Choose Image > Apply Data Set. Select the data set from the list and preview the image in the document window. To apply the data set, click Apply. Click cancel if you are previewing and don't want to change the base image.

You can also apply and preview a data set in the Data Set page of the Variables dialog box.

Generate graphics using data sets

After you define variables and one or more data sets, you can output, in batch mode, images using the data set values. You can output images as PSD files.

- 1 Choose File > Export > Data Sets As Files.
- 2 Enter a base name for all files generated. You may create your own file-naming scheme if you want.
- 3 Click the Select Folder button to select a destination directory for your files.
- 4 Choose data sets to export.
- 5 Click OK.

Creating data sets in external files

You can quickly create a large number of data sets by creating an external text file that contains all the variable information and loading that file into a PSD document containing variables. One method is to enter your data into a text file or Microsoft Excel spreadsheet and then export it to a tab or comma-separated file.

The syntax of the external text file is as follows (where each line that starts with "Variable" or "Value" is an entire line by itself in your file):

```
VariableName1<sep>VariableName2<sep> <sep>VariableNameN <nl>
Value1-1<sep>Value2-1<sep><sep><sep>ValueN-1<nl>
Value1-2<sep>Value2-2<sep><sep>ValueN-2<nl>
Value1-M<sep>Value2-M<sep><sep>ValueN-M<nl>
```

All the variable names are listed on the first line, in the order that the values are given in subsequent lines. Each subsequent line represents one data set, with the values for each variable given.

 *To create multiple lines of text in a single line of text in a data set, enclose the text in double quotes and insert hard returns in the tab- or comma-separated file where you want the breaks to occur.*

External text file syntax elements	
<sep>	Either a comma-separated (CSV) or a tab (tab-delimited) file that separates each variable name or value.
<nl>	A newline character that ends each data set and can be a line feed, carriage return, or both.
"true" and "false"	Allowed values for a visibility variable.
Spaces	Spaces around the delimiter are removed when parsing the file; between words in a value string (e.g., two of a kind) spaces are maintained and leading and trailing spaces are maintained if enclosed in double quotes (e.g., "one kind").
Double quotes	Can be part of a value if preceded by another double quote (e.g., ""B"" would be "B" in the data set).

If <sep> or <nl> is part of the variable value, then the entire value must be enclosed in double quotes.

All variables defined in the PSD document must be defined in the text file. An error is displayed if the number of variables in the text file does not match the number in the document.

Example data set:

Using a template for flowers that holds variables for tulip and sunflower, you can set up a text file that looks like this:

```
{contents of FlowerShow.txt}
Variable 1, Variable 2, Variable 3
true, TULIP, c:\My Documents\tulip.jpg
false, SUNFLOWER, c:\My Documents\sunflower.jpg
false, CALLA LILY, c:\My Documents\calla.jpg
true, VIOLET, c:\My Documents\violet.jpg
```

Note: You can use a relative path for the image location if the text file is in the same folder as the image file. For example, the last item in the example can be: true, VIOLET, violet.jpg.

Import a data set

- 1 Do one of the following:
 - Choose File > Import > Variable Data Sets.
 - Choose Image > Variables > Data Sets and click the Import button.
- 2 Navigate to the text file to import.
- 3 Set up your import options.

Use First Column For Data Set Names Names each data set using the content of the first column of the text file (the values for the first variable listed). Otherwise, the data sets are named "Data Set 1, Data Set 2, and so on."

Replace Existing Data Sets Deletes any existing data sets before importing.

- 4 Set the encoding of the text file or leave the setting Automatic.
- 5 Click OK.

Saving templates for use with other Adobe products

You can save a template in PSD format for use with other Adobe products, such as Adobe Graphics Server (available only in English) and Adobe GoLive. For example, a GoLive user can place a PSD template in a page layout, bind its variables to a database using dynamic links, and then use Graphics Server to generate iterations of the artwork. Likewise, a developer working with Graphics Server can bind the variables in the PSD file directly to a database or another data source.

For more information on using PSD templates to create data-driven graphics, see Adobe GoLive Help and the Adobe Graphics Server Developer Guide.

Chapter 21: Optional plug-ins

Photoshop includes several optional plug-ins, extensions, and presets that are not installed with your application. You can find many of these items in the Goodies folder of your application disc. The Goodies folder also includes an OptionalPluginsReadMe PDF file with instructions on how to install the plug-ins and presets, as well as information on where to download additional, older plug-ins.

Picture packages and contact sheets

Place multiple photos into a picture package

With the Picture Package command, you can place multiple copies of a source image on a single page, much as portrait studios do with school photos and other photo packages. You also have the option of placing different images on the same page. You can choose from a variety of size and placement options to customize your package layout.



A picture package layout

1 Do one of the following:

- (Photoshop) Choose File > Automate > Picture Package. If you have multiple images open, Picture Package uses the frontmost image.
- (Bridge) Choose Tools > Photoshop > Picture Package. The Picture Package command uses the first image listed in Bridge unless you select a specific image before giving the Picture Package command.

If you're using only the frontmost image or a selected image from Bridge, skip to step 3.

2 Add one or more images to the layout by doing one of the following:

- In the Source Images area of the Picture Package dialog box, choose either File or Folder from the Use menu and click Browse (Windows) or Choose (Mac OS). If you choose Folder, you can select Include All Subfolders to include images inside any subfolders.
- Click a placeholder in the preview layout and browse to select an image.

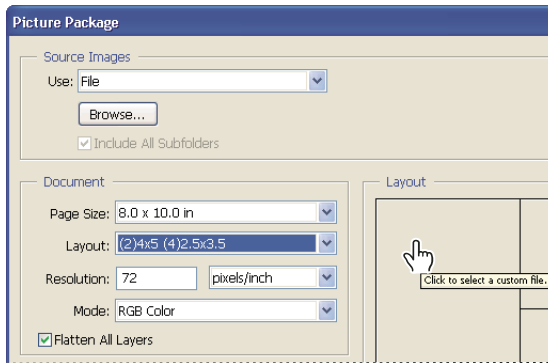

Click a placeholder in the Picture Package preview layout, then browse to select an image.

- Drag an image from the desktop or a folder into a placeholder.

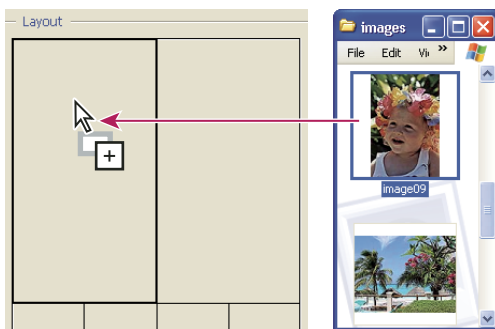

Add an image to a picture package by dragging the image from the desktop into a placeholder.

You can change any image in the layout by clicking a placeholder and browsing to select an image.

- 3 In the Document area of the Picture Package dialog box, select page size, layout, resolution, and color mode. A thumbnail of the chosen layout appears on the right side of the dialog box. You can also create your own custom layouts.
- 4 Select Flatten All Layers to create a picture package with all images and label text on a single layer. Deselect Flatten All Layers to create a picture package with separate image layers and text layers (for labels). If you place each image and label on a separate layer, you can update your picture package after it's been saved. However, the layers increase the file size of your picture package.
- 5 In the Label area, choose the source for label text from the Content menu or choose None. If you choose Custom Text, enter the text for the label in the Custom Text field.
- 6 Specify font, font size, color, opacity, position, and rotation for the labels.
- 7 Click OK.

Customize a picture package layout

You can modify existing layouts or create new layouts using the Picture Package Edit Layout feature. Your custom layouts are saved as text files and stored in the Layouts folder inside the Presets folder. You can then reuse your saved layouts. The Picture Package Edit Layout feature uses a graphic interface that eliminates the need to write text files to create or modify layouts.

- 1 Do one of the following:
 - (Photoshop) Choose File > Automate > Picture Package.
 - (Bridge) Choose Tools > Photoshop > Picture Package.
- 2 In the Picture Package dialog box, choose a layout from the Layout menu if you're creating a layout or customizing an existing one.
- 3 Click the Edit Layout button.
- 4 In the Picture Package Edit Layout dialog box, enter a name for the custom layout in the Name text box.
- 5 (Optional) In the Layout area of the Picture Package Edit Layout dialog box, choose a size from the Page Size menu or enter values in the Width and Height text boxes. You can use the Units menu to specify inches, centimeters, pixels, or millimeters.

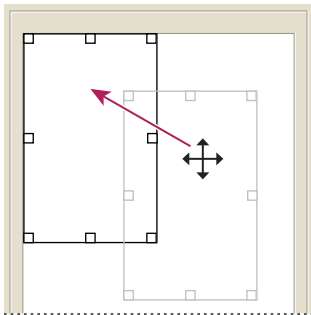

Dragging a placeholder to a new location in the Picture Package layout

- 6 In the Grid area of the Picture Package Edit Layout dialog box, select the Snap To option to display a grid to help you position the elements in the custom layout. Enter a value in the Size text box to change the appearance of the grid.
- 7 To add or delete a placeholder, do one of the following:
 - Click Add Zone to add a placeholder to the layout.
 - Select a placeholder and click Delete Zone to delete it from the layout.
- 8 To modify a placeholder, select a placeholder and do any of the following:
 - Enter values in the Width and Height text boxes to resize a placeholder.
 - Click and drag a handle to resize a placeholder. If you resize a rectangle placeholder with an image in it, Picture Package will snap the image within the vertical or horizontal placeholder, depending on the way the zone is being resized.
 - Enter values in the X and Y text boxes to move a placeholder.
 - Click and drag a placeholder to the location you want in the layout.
- 9 Click Save.

Create a contact sheet

 To create more effective contact sheets, use the Adobe Output Module in Adobe Bridge. For more information, search Bridge Help for “contact sheet output module.” Install the optional Photoshop plug-in described here only if you have an existing workflow that requires it.

Contact sheets let you easily preview and catalog groups of images by displaying a series of thumbnails on a single page. You can automatically create and place thumbnails on a page using the Contact Sheet II command.



A contact sheet

1 Do one of the following:

- (Photoshop) Choose File > Automate > Contact Sheet II.
- (Bridge) Select a folder of images or specific image files. From the Bridge menu, choose Tools > Photoshop > Contact Sheet II. Unless you select specific images, the contact sheet will include all the images currently displayed in Adobe Bridge. You can select a different image folder or select other currently open images after the Contact Sheet II dialog box opens.

Note: Click to select an image in Bridge. Shift-click to select a series of images. Ctrl-click (Windows) or Command-click (Mac OS) to select noncontiguous images.

2 In the Contact Sheet II dialog box, specify the images to use by choosing one of the following from the Use menu in the Source Images area:

Current Open Documents Uses any image that is currently open in Photoshop.

Folder Lets you click Browse (Windows) or Choose (Mac OS) to specify the folder containing the images you want to use. Select Include All Subfolders to include images inside any subfolders.

Selected Images From Bridge Uses images displayed in Bridge. All images in Bridge are used unless you select specific images before choosing the Contact Sheet II command. Images in subfolders are not included.

3 In the Document area, specify the dimensions, resolution, and color mode for the contact sheet. Select Flatten All Layers to create a contact sheet with all images and text on a single layer. Deselect Flatten All Layers to create a contact sheet in which each image is on a separate layer and each caption is on a separate text layer.

4 In the Thumbnails area, specify layout options for the thumbnail previews.

- For Place, choose whether to arrange thumbnails across first (from left to right, then top to bottom) or down first (from top to bottom, then left to right).
- Enter the number of columns and rows that you want per contact sheet. The maximum dimensions for each thumbnail are displayed to the right, along with a visual preview of the specified layout.

- Select Use Auto-Spacing to let Photoshop automatically space the thumbnails in the contact sheet. If you deselect Use Auto-Spacing, you can specify the vertical and horizontal space around the thumbnails. The contact sheet preview in the dialog box is automatically updated as you specify the spacing.
- Select Rotate For Best Fit to rotate the images, regardless of their orientation, so they fit efficiently on a contact sheet.



When Rotate For Best Fit is deselected, thumbnails appear in their correct orientation (left). When it is selected, the pictures are rotated to achieve the best fit (right).

- 5 Select Use Filename As Caption to label the thumbnails using their source image filenames. Use the menu to specify a caption font and font size.
- 6 Click OK.

Creating web photo galleries

 To create more effective web galleries, use the Adobe Output Module in Adobe Bridge. For more information, search Bridge Help for “photo gallery output module.” Install the optional Photoshop plug-in described here only if you have an existing workflow that requires it.

About web photo galleries

A web photo gallery is a web site that features a home page with thumbnail images and gallery pages with full-size images. Each page contains links that allow visitors to navigate the site. For example, when a visitor clicks a thumbnail image on the home page, the associated full-size image is loaded into a gallery page. You use the Web Photo Gallery command to automatically generate a web photo gallery from a set of images.

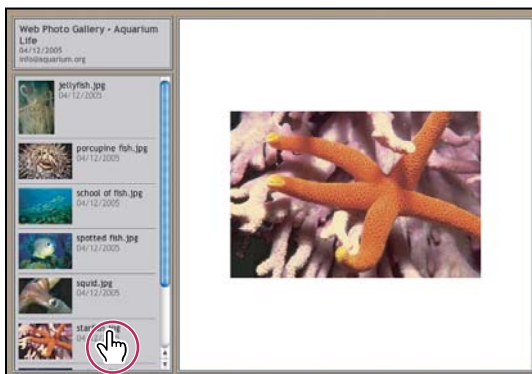

Web photo gallery home page

Photoshop provides a variety of styles for your gallery, which you can select using the Web Photo Gallery command. If you are an advanced user who knows HTML, you can create a new style or customize a style by editing a set of HTML template files.

Each template for gallery styles comes with different options. If you're using a preset style, some options may be dimmed, or unavailable in that particular style.

Create a web photo gallery

1 (Optional) Select the files or folder you want to use in Adobe Bridge.

Your images will be presented in the order in which they're displayed in Bridge. If you'd rather use a different order, change the order in Bridge.

2 Do one of the following:

- In Adobe Bridge, choose Tools > Photoshop > Web Photo Gallery.
- In Photoshop, choose File > Automate > Web Photo Gallery.

3 Choose a style for the gallery from the Styles pop-up menu. A preview of the home page for the chosen style appears in the dialog box.

4 (Optional) Enter an e-mail address as the contact information for the gallery.

5 Choose the source files for your gallery from the Use menu.

Selected Images From Bridge Uses images you selected before opening the Web Photo Gallery dialog box.

Folder Uses images from folders you select using the Browse (Windows) or Choose (Mac OS) buttons. Select Include All Subfolders to include images inside any subfolders of the selected folder.

6 Click Destination, and then select a folder in which to store the images and HTML pages for the gallery. Then click OK (Windows) or Choose (Mac OS).

7 Select formatting options for the web gallery. Choose from the Options menu to display each set of options. See [“Web photo gallery options”](#) on page 639.

8 Click OK. Photoshop places the following HTML and JPEG files in your destination folder:

- A home page for your gallery named index.htm or index.html, depending on the Extension options. Open this file in any web browser to preview your gallery.
- JPEG images inside an images subfolder.
- HTML pages inside a pages subfolder.
- JPEG thumbnail images inside a thumbnails subfolder.

Making sure that your colors match

If you work with photos in a wide-gamut color working space such as ProPhoto RGB or Adobe RGB, image colors may change when viewed in a web gallery by a browser that doesn't read embedded color profiles. If this happens, try converting the image profiles to sRGB (which most browsers use as a default) before optimizing them or including them in a Web Photo Gallery. Convert them to sRGB in one of the following ways. It is a good idea to work with a copy of the images.

- To convert a single image, choose Edit > Convert To Profile and then choose sRGB. See [“Assign or remove a color profile \(Illustrator, Photoshop\)”](#) on page 142.
- To convert a folder of images, use the Image Processor. Choose File > Scripts > Image Processor. See [“Convert files with the Image Processor”](#) on page 622.

If you use the Image Processor, you can save the files directly to JPEG format in the size that you want them. If you do so, make sure to turn Resize Images off in the Large Image options.

Web photo gallery options

General Options for file extensions, encoding, and metadata.

- **Extension** Uses either .htm or .html as the filename extension.
- **Use UTF 8 Encoding For URL** Uses UTF-8 encoding.
- **Add Width And Height Attributes For Images** Specifies dimensions, shortening download time.
- **Preserve All Metadata** Maintains metadata info.

Banner Text options for the banner that appears on each page in the gallery. Enter text for each of these:

- **Site Name** The name of the gallery.
- **Photographer** The name of the person or organization receiving credit for the photos in the gallery.
- **Contact Info** The contact information for the gallery, such as a telephone number or a business address.
- **Date** The date appearing on each page of the gallery. By default, Photoshop uses the current date.
- **Font and Font Size** (Available for some site styles) Options for the banner text.

Large Images Options for the main images that appear on each gallery page.

- **Add numeric links** (Available for some site styles) Places a numeric sequence (starting at 1, ending with the total number of pages in the gallery) running horizontally at the top of each gallery page. Each number is a link to the respective page.
- **Resize Images** Resizes the source images for placement on the gallery pages. Choose a size from the pop-up menu or enter a size in pixels. For Constrain, choose which dimensions of the image you want to constrain during resizing. For JPEG Quality, choose an option from the pop-up menu, enter a value between 0 and 12, or drag the slider. The higher the value, the better the image quality and the larger the file.

Note: Photoshop uses the default image interpolation method set in preferences. Choose Bicubic Sharper as the default for best results when reducing image size.

- **Border Size** Specifies the width, in pixels, of the border around the image.
- **Titles Use** (Available for some site styles) Specifies options for displaying captions under each image. Select Filename to display the filename, or select Description, Credits, Title, and Copyright to display description text drawn from the File Info dialog box.
- **Font and Font Size** (Available for some site styles) Specify the font and size of the caption.

Thumbnails Options for the gallery home page, including the size of the thumbnail images.

- **Size** Specifies the thumbnail size. Choose from the pop-up menu or enter a value in pixels for the width of each thumbnail.
- **Columns and Rows** Specify the number of columns and rows in which to display thumbnails on the home page. This option doesn't apply to galleries that use the Horizontal Frame Style or Vertical Frame Style.
- **Border Size** Specifies the width, in pixels, of the border around each thumbnail.
- **Titles Use** (Available for some site styles) Specifies options for displaying captions under each thumbnail. Select Filename to display the filename, or select Description, Credits, Title, and Copyright to display description text drawn from the File Info dialog box.
- **Font and Font Size** (Available for some site styles) Specify the font and size of the caption.

Custom Colors Options for colors of elements in the gallery. To change the color of an element, click its color swatch and then select a new color from the Adobe Color Picker. You can change the background color of each page (Background option) and of the banner (Banner option).

Security Displays text over each image as a theft deterrent.

- **Content** Specifies the text to be displayed. Select Custom Text to enter customized text. Select Filename, Description, Credits, Title, or Copyright to display text drawn from the File Info dialog box.
- **Font, Color, and Position** Specify the font, color, and alignment of the caption.
- **Rotate** Place the text on the image at an angle.

Web photo gallery styles

Photoshop provides a variety of styles for your web photo gallery. If you are an advanced user who knows HTML, you can create a new style or customize a style by editing a set of HTML template files.

The web photo gallery styles provided by Photoshop are stored in individual folders in the following locations:

Windows Program Files/Adobe/Adobe Photoshop CS4/Presets/Web Photo Gallery.

Mac OS Adobe Photoshop CS4/Presets/Web Photo Gallery.

The name of each folder in this location appears as an option in the Styles menu in the Web Photo Gallery dialog box. Each folder contains the following HTML template files, which Photoshop uses to generate the gallery:

Caption.htm Determines the layout of the caption that appears below each thumbnail on the home page.

FrameSet.htm Determines the layout of the frame set for displaying pages.

IndexPage.htm Determines the layout of the home page.

SubPage.htm Determines the layout of the gallery pages with full-size images.

Thumbnail.htm Determines the layout of the thumbnails that appear on the home page.

Each template file contains HTML code and tokens. A *token* is a text string that is replaced by Photoshop when you set its corresponding option in the Web Photo Gallery dialog box. For example, a template file may contain the following TITLE element that uses a token as its enclosed text:

```
<TITLE>%TITLE%</TITLE>
```

When Photoshop generates the gallery using this template file, it replaces the token %TITLE% with the text that you entered for Site Name in the Web Photo Gallery dialog box.

To better understand an existing style, you can open and study its HTML template files using an HTML editor. Because only standard ASCII characters are required to create HTML documents, you can open, edit, and create these documents using a plain-text editor such as Notepad (Windows) or TextEdit (Mac OS).

About customizing web photo gallery styles

You can customize an existing web photo gallery style by editing one or more of its HTML template files. When customizing a style, you need to follow these guidelines so that Photoshop can generate the gallery correctly:

- The style folder must contain these files: Caption.htm, IndexPage.htm, SubPage.htm, Thumbnail.htm, and FrameSet.htm.
- You can rename the style folder but not the HTML template files in the folder.

- You can have an empty Caption.htm file, and place the HTML code and tokens determining the layout of the caption in the Thumbnail.htm file.
- You can replace a token in a template file with the appropriate text or HTML code, so that an option is set through the template file rather than through the Web Photo Gallery dialog box. For example, a template file may contain a BODY element with the following background color attribute that uses a token as its value:

```
bgcolor=%BGCOLOR%
```

To set the background color of the page to red, you can replace the token %BGCOLOR% with “FF0000.”
- You can add HTML code and tokens to the template files. All tokens must be in uppercase characters, and begin and end with the percent (%) symbol.

Customize or create a web photo gallery style

- 1 Locate the folder that stores the existing web photo gallery styles.
- 2 Do one of the following:
 - To customize a style, create a copy of the style folder, and store it in the same location as the existing style folders.
 - To create a new style, create a new folder for the new style, and store it in the same location as the existing style folders.

The new or customized style (named for its folder) appears in the Styles menu in the Web Photo Gallery dialog box.

- 3 Using an HTML editor, do one of the following:
 - Customize the HTML template file.
 - Create the necessary HTML template files and store them inside the style folder.

When creating the template files, make sure that you follow the guidelines for customization outlined in [“About customizing web photo gallery styles”](#) on page 640.

Important: When customizing or creating a template for a gallery style, you should place each of the following tokens on a separate line in the HTML file: %CURRENTINDEX%, %NEXTIMAGE%, %NEXTINDEX%, %PAGE%, %PREVIMAGE%, and %PREVINDEXT%. When generating specific pages of a gallery, Photoshop skips lines in a template that contain tokens that don't apply to those pages. For example, when Photoshop generates the first gallery page, it skips any line in the template that contains the %PREVIMAGE% token, which determines the link to the previous gallery page. By keeping the %PREVIMAGE% token on a separate line, you ensure that Photoshop doesn't ignore other tokens in the template.

Web photo gallery style tokens

Photoshop uses tokens in the HTML template files to define a default web photo gallery style. Photoshop uses these tokens to generate a gallery based on user input in the Web Photo Gallery dialog box.

When customizing or creating a gallery style, you can add any token to any HTML template file, with the exception of %THUMBNAILS% and %THUMBNAILSROWS%, which can appear only in the IndexPage.htm file. When adding a token, keep in mind that you may also need to add HTML code to the file so that the token is used correctly.

You can use the following tokens in the HTML template files:

%ALINK% Determines the color of active links.

%ALT% Determines the name of an image file.

%ANCHOR% Provides the ability to return to the thumbnail of the image the user is viewing, rather than the beginning of the index. This takes effect when the user clicks the Home button.

- %BANNERCOLOR%** Determines the color of the banner.
- %BANNERFONT%** Determines the font of the banner text.
- %BANNERFONTSIZE%** Determines the font size of the banner text.
- %BGCOLOR%** Determines the background color.
- %CAPTIONFONT%** Determines the font of the caption below each thumbnail on the home page.
- %CAPTIONFONTSIZE%** Determines the font size of the caption.
- %CAPTIONTITLE%** Inserts the document title for a caption from the file information.
- %CHARSET%** Determines the character set used on each page.
- %CONTACTINFO%** Determines the contact information for the gallery, such as phone number and location.
- %CONTENT_GENERATOR%** Expands to “Adobe Photoshop CS4 Web Photo Gallery.”
- %COPYRIGHT%** Inserts the copyright information for a caption from the file information.
- %CREDITS%** Inserts the credits for a caption from the file information.
- %CURRENTINDEX%** Determines the link for the current home page.
- %CURRENTINDEXANCHOR%** Resides in SubPage.htm and points to the first index page.
- %DATE%** Determines the date that appears on the banner.
- %EMAIL%** Determines the e-mail address contact information for the gallery.
- %FILEINFO%** Determines the image file information for a caption.
- %FILENAME%** Determines the filename of an image. Use this for metadata that appears as HTML text.
- %FILENAME_URL%** Determines the URL filename of an image. Use this for URL filenames only.
- %FIRSTPAGE%** Determines the link for the first gallery page that appears in the right frame of a frame set.
- %FRAMEINDEX%** Determines the link for the home page that appears in the left frame of a frame set.
- %HEADER%** Determines the title of the gallery.
- %IMAGEBORDER%** Determines the border size of the full-size image on a gallery page.
- %IMAGE_HEIGHT%** Enables the Add Width And Height Attributes For Images check box. This allows the user to download the attributes, reducing download time.
- %IMAGE_HEIGHT_NUMBER%** This token is replaced by a numeral (only) representing the width of the image.
- %IMAGEPAGE%** Determines the link to a gallery page.
- %IMAGE_SIZE%** If the Resize Images box is selected, this token contains the image pixel value used in the Large Images panel. If the box is not selected, this token contains an empty string. This is useful for JavaScript in the templates, because it can show the maximum height and width values for all images for the generated site.
- %IMAGESRC%** Determines the URL for a full-size image on a gallery page.
- %IMAGE_WIDTH%** Enables the Add Width And Height Attributes For Images check box. This allows the user to download the attributes, reducing download time.
- %IMAGE_WIDTH_NUMBER%** This token is replaced by a numeral (only) representing the width of the image.
- %LINK%** Determines the color of links.
- %NEXTIMAGE%** Determines the link for the next gallery page.

- %NEXTIMAGE_CIRCULAR%** Sets the link from large preview image to next large preview image.
- %NEXTINDEX%** Determines the link for the next home page.
- %NUMERICLINKS%** Inserts numbered links on subpages to all large preview images.
- %PAGE%** Determines the current page location (for example, page 1 of 3).
- %PHOTOGRAPHER%** Determines the name of the person or organization receiving credit for the photos in the gallery.
- %PREVIMAGE%** Determines the link for the previous gallery page.
- %PREVINDEXTITLE%** Determines the link for the previous home page.
- %SUBPAGEHEADER%** Determines the title of the gallery.
- %SUBPAGETITLE%** Determines the title of the gallery.
- %TEXT%** Determines the text color.
- %THUMBORDER%** Determines the size of thumbnail borders.
- %THUMBNAIL_HEIGHT%** Enables the Add Width And Height Attributes For Images check box. This allows the user to download the attributes, reducing download time.
- %THUMBNAIL_HEIGHT_NUMBER%** This token is replaced with a numeral (only) representing the height of the thumbnail.
- %THUMBNAILS%** This token is replaced with thumbnails using the Thumbnail.htm file for the frame styles. You must place this token alone in a single, nonbreaking line in the HTML file.
- %THUMBNAIL_SIZE%** Contains the thumbnail pixel value in the Thumbnails panel. This is useful for JavaScript in the templates, as it can show the maximum height and width values for all thumbnails for the generated site.
- %THUMBNAILSRC%** Determines the link to a thumbnail.
- %THUMBNAILSROWS%** This token is replaced with rows of thumbnails using the Thumbnail.htm file for the nonframe styles. You must place this token alone in a single, nonbreaking line in the HTML file.
- %THUMBNAIL_WIDTH%** Enables the Add Width And Height Attributes For Images check box. This allows the user to download the attributes, reducing download time.
- %THUMBNAIL_WIDTH_NUMBER%** This token is replaced by a numeral (only) representing the width of the thumbnail.
- %TITLE%** Determines the title of the gallery.
- %VLINK%** Determines the color of visited links.

Extract an object from its background

The Extract filter provides a sophisticated way to isolate a foreground object and erase its background on a layer. Even objects with wispy, intricate, or undefinable edges may be clipped from their backgrounds with a minimum of manual work. You use tools in the Extract dialog box to specify which part of the image to extract.



For simpler cases, try using the Background Eraser tool.

When you extract the object, Photoshop erases its background to transparency. Pixels on the edge of the object lose the color components derived from the background, so they can blend with a new background without producing a color halo.

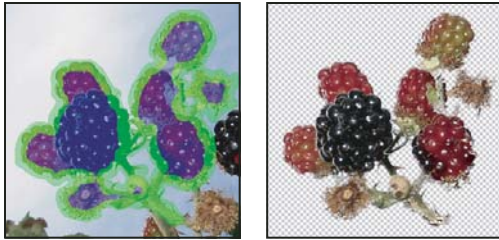

Selected area highlighted and filled, and extracted object

 You can add back opacity to the background and create other effects using the *Edit > Fade Extract* command after an extraction.

- 1 In the Layers palette, select the layer containing the object you want to extract. If you select a background layer, it becomes a normal layer after the extraction. If the layer contains a selection, the extraction erases the background only in the selected area.

 To avoid losing the original image information, duplicate the layer or make a snapshot of the original image state.

- 2 Choose *Filter > Extract*, and then specify tool options:

Brush Size Enter a value, or drag the slider to specify the width of the Edge Highlighter tool . You also use the Brush Size option to specify the width of the Eraser, Cleanup, and Edge Touchup tools.

Highlight Choose a preset color option for the highlight that appears around objects when you use the Edge Highlighter tool, or choose *Other* to pick a custom color for the highlight.

Fill Choose a preset color option, or choose *Other* to pick a custom color for the area covered by the Fill tool.

Smart Highlighting Select this option if you are highlighting a well-defined edge. The option helps you keep the highlight on the edge, and applies a highlight that is just wide enough to cover the edge, regardless of the current brush size.

Note: If you use *Smart Highlighting* to mark an object edge that's near another edge, decrease the brush size if conflicting edges pull the highlight off the object edge. If the object edge has a uniform color on one side and high-contrast edges on the other side, keep the object edge within the brush area but center the brush on the uniform color.

Specify Extraction options:

Textured Image Select this option if the foreground or background of your image contains a lot of texture.

Smooth Enter a value or drag the slider to increase or decrease the smoothness of the outline. It's usually best to begin with zero or a small value to avoid unwanted blurring of details. If there are sharp artifacts in the extraction result, you can increase the Smooth value to help remove them in the next extraction.

Channel Choose the alpha channel from the Channel menu to base the highlight on a selection saved in an alpha channel. The alpha channel should be based on a selection from the edge boundary. If you modify a highlight based on a channel, the channel name in the menu changes to *Custom*. Your image must have an alpha channel for the Channel option to be available.

Force Foreground Select this option if the object is especially intricate or lacks a clear interior.

- 3 Select the Edge Highlighter tool , and draw to define the edge of the object you want to extract. Drag so that the highlight slightly overlaps both the foreground object and its background. Use a large brush to cover wispy, intricate edges where the foreground blends into the background, as with hair or trees.



 Use either the *Zoom* tool or the *Hand* tool to adjust the view as needed.

If you need to erase the highlight, select the Eraser tool , and drag it over the highlight. To erase the entire highlight, press Alt+Backspace (Windows) or Option+Delete (Mac OS).

If the object has a well-defined interior, make sure the highlight forms a complete enclosure. You do not need to highlight areas where the object touches the image boundaries. If the object lacks a clear interior, highlight the entire object.

Note: You can't highlight the entire object if you've selected *Textured Image* or *Force Foreground*.

4 Define the foreground area by doing one of the following:

- If the object has a well-defined interior, select the Fill tool . Click inside the object to fill its interior. Clicking a filled area again with the Fill tool removes the fill.
- If you've selected *Force Foreground*, select the Eyedropper tool , and click inside the object to sample the foreground color, or click in the Color text box and use a Color Picker to select the foreground color. This technique works best with objects that contain tones of a single color.

5 (Optional) Click Preview to preview the extracted object. Zoom in as needed.

Show Choose a menu option to switch between views of the original and the extracted image.



Display Choose a menu option to preview the extracted object against a colored matte background or a grayscale background. To display a transparent background, choose None.

6 (Optional) Improve the extraction by doing one of the following:

- Choose new Highlight and Fill options and draw again with the Edge Highlighter tool. Define the foreground area once more, and then preview the extracted object.
- Specify new Extraction settings (Smooth, Force Foreground, or Color) and then preview the extracted object.

When you are satisfied with the extraction, you can do the final touchups.

7 Touch up the extraction results by doing one of the following:

- To erase background traces in the extracted area, use the Cleanup tool . The tool subtracts opacity and has a cumulative effect. You can also use the Cleanup tool to fill gaps in the extracted object. Hold down Alt (Windows) or Option (Mac OS) while dragging to add back opacity.
- To edit the edge of the extracted object, use the Edge Touchup tool . The tool sharpens edges and has a cumulative effect. If there is no clear edge, the Edge Touchup tool adds opacity to the object or subtracts opacity from the background.

 You can also clean up the image after an extraction by using the Background Eraser and History Brush tools in the toolbox.

8 Click OK to apply the final extraction. On the layer, all pixels outside the extracted object are erased to transparency.

Generate a pattern using the Pattern Maker

The Pattern Maker filter slices and reassembles an image to make a pattern. The Pattern Maker works in two ways:

- Fills a layer or selection with a pattern. The pattern can be made of one large tile, or multiple duplicate tiles.
- Creates tiles that you can save as a pattern preset and use with other images.

You can generate multiple patterns from the same sample until you find one that you like.

1 Do one of the following:

- Select the layer that contains the area from which you want to generate the pattern. The layer you select will be replaced by the generated pattern, so it's a good idea to make a copy of the layer first.
- To generate a pattern in a new layer or file, make a rectangular selection of the image you are using to generate the pattern, and choose Edit > Copy. Then add a layer to the image, or create a new file with the dimensions you want the final image to have.

2 Choose Filter > Pattern Maker.

3 Specify the source of the pattern.

- Choose Use Clipboard As Sample to use the contents of the clipboard if you copied an image before you opened the Pattern Maker.
- Make a selection in the preview area with the Pattern Maker's Marquee tool . To move the selection marquee, drag it to a different location.

Note: You can use the Zoom and Hand tools to navigate in the preview area. Use Alt (Windows) or Option (Mac OS) with the Zoom tool to zoom out. The magnification appears at the bottom of the dialog box.

4 Specify the tile size.

- Enter pixel dimensions in the Width and Height boxes.
- Click Use Image Size to generate a pattern with one tile that fills the layer.

5 Click Generate. You can press Esc to cancel the generation.

The preview area is tiled with the generated pattern.

- To switch between the generated preview and the source image, choose an option from the Show menu.
 - To view the boundary of individual tiles, click Tile Boundaries.
 - To offset the tiles in the generated pattern, choose a direction from the Offset pop-up menu and specify an offset amount in the Amount text box. The offset amount is a percentage of the tile dimension in the specified direction. The offset has no effect on saved pattern preset tiles.
- 6** Click Generate Again to generate additional patterns using the same options, or adjust the options and then click Generate Again.

Smoothness Adjusts the sharp edges in the pattern. Increase the smoothness to reduce edges.

Sample Detail Specifies the size of pattern slices in the tile. A high value maintains more of the original detail in the pattern. A low value uses smaller slices in the tile. Tiles take longer to generate when you use a high value.

7 Navigate through the generated tiles in the Tile History panel to select the tile that you want to use to fill the layer or to save as a pattern preset.

- To move through the tiles you've generated, click the First Tile button, Previous Tile button, Next Tile button, or Last Tile button. Or, type the number of the pattern preview you want to view, and press Enter (Windows) or Return (Mac OS).
- To view how the tile looks as a repeating pattern in the preview area, make sure that Update Pattern Preview is selected. If tile previewing is slow, deselect this option, find the tile you want, and then select the option.
- To delete a tile and pattern preview, navigate to the tile you want to delete, and click the Delete icon.
- To save a tile as a preset pattern, navigate to the tile you want to save, and click the Save Preset Pattern button. Enter a preset name, and click OK. When you save a tile as a preset pattern, only a single tile is saved, not the full, generated pattern.



Tile History buttons

A. Save Preset Pattern B. First Tile C. Previous Tile D. Next Tile E. Last Tile F. Delete icon

- 8 When you are satisfied with a pattern preview and you have saved the tiles that you might want to use in the future, click OK to fill the layer or selection.

If you are creating preset patterns only, click Cancel to close the dialog box without filling the layer.

Import an image using the TWAIN interface

TWAIN is a cross-platform interface for acquiring images captured by certain scanners, digital cameras, and frame grabbers. The manufacturer of the TWAIN device must provide a Source Manager and TWAIN data source for your device to work with Photoshop.

The TWAIN plug-in is optional only for Mac OS. On 32-bit versions of Windows, Photoshop installs the TWAIN plug-in automatically. 64-bit versions of Windows do not support the TWAIN plug-in.

- ❖ Choose File > Import, and choose the device you want to use from the submenu.

You must install the TWAIN device and its software and restart your computer before you can use it to import images into Photoshop. See the documentation provided by your device manufacturer for installation information.

Chapter 22: Keyboard shortcuts

Keyboard shortcuts make you more productive in Photoshop. You can use the default shortcuts listed here, or add and customize shortcuts to suit your needs.

Customizing keyboard shortcuts

About customizing keyboard shortcuts

Photoshop lets you view a list of all shortcuts, and edit or create shortcuts. The Keyboard Shortcuts dialog box serves as a shortcut editor, and includes all commands that support shortcuts, some of which aren't addressed in the default shortcut set.

 *In addition to using keyboard shortcuts, you can access many commands using context-sensitive menus. Context-sensitive menus display commands that are relevant to the active tool, selection, or panel. To display a context-sensitive menu, right-click (Windows) or Control-click (Mac OS) in the document window or panel.*

Define new keyboard shortcuts

- 1 Do one of the following:
 - Choose Edit > Keyboard Shortcuts.
 - Choose Window > Workspace > Keyboard Shortcuts & Menus and click the Keyboard Shortcuts tab.
- 2 Choose a set of shortcuts from the Set menu at the top of the Keyboard Shortcuts & Menus dialog box.
- 3 Choose a shortcut type from the Shortcuts For menu:



Application Menus Lets you customize keyboard shortcuts for items in the menu bar.

Panel Menus Lets you customize keyboard shortcuts for items in panel menus.

Tools Lets you customize keyboard shortcuts for tools in the toolbox.

- 4 In the Shortcut column of the scroll list, select the shortcut you want to modify.
- 5 Type a new shortcut.

If the keyboard shortcut is already assigned to another command or tool in the set, an alert appears. Click Accept to assign the shortcut to the new command or tool and erase the previously assigned shortcut. After you reassign a shortcut, you can click Undo Changes to undo the change, or click Accept and Go To Conflict to assign a new shortcut to the other command or tool.

- 6 When you're finished changing shortcuts, do one of the following:
 - To save all changes to the current set of keyboard shortcuts, click the Save Set button . Changes to a custom set are saved. If you're saving changes to the Photoshop Defaults set, the Save dialog box opens. Enter a name for the new set and click Save.
 - To create a new set based on the current set of shortcuts, click the Save Set As button . In the Save dialog box, enter a name for the new set in the Name text box, and click Save. The new keyboard shortcut set will appear in the pop-up menu under the new name.
 - To discard the last saved change without closing the dialog box, click Undo.

- To return a new shortcut to the default, click Use Default.
- To export the displayed set of shortcuts, click Summarize. You can use this HTML file to display the set of shortcuts in a web browser.
- To discard all changes and exit the dialog box, click Cancel.

Note: If you haven't saved the current set of changes, you can click Cancel to discard all changes and exit the dialog box.

Clear shortcuts from a command or tool

- 1 Choose Edit > Keyboard Shortcuts.
- 2 In the Keyboard Shortcuts dialog box, select the command or tool name whose shortcut you want to delete.
- 3 Click Delete Shortcut.

Delete a set of shortcuts

- 1 Choose Edit > Keyboard Shortcuts.
- 2 In the Set pop-up menu, choose the shortcut set that you want to delete.
- 3 Click the Delete icon  and then click OK to exit the dialog box.

Default keyboard shortcuts

Keys for selecting tools

In Photoshop, you can customize shortcuts using the Keyboard Shortcuts command. Choose Edit > Keyboard Shortcuts. For more information, see [“Define new keyboard shortcuts”](#) on page 648.

Holding down a key temporarily activates a tool. Letting go of the key returns to the previous tool.

Note: In rows with multiple tools listed, use the same shortcut to toggle through the different tools (they are grouped by shortcuts just as they are grouped in the Tools panel).

Result	Windows	Mac OS
Cycle through tools with the same shortcut key	Shift-press shortcut key (if Use Shift Key for Tool Switch preference is selected)	Shift-press shortcut key (if Use Shift Key for Tool Switch preference is selected)
Cycle through hidden tools	Alt-click + tool (except add anchor point, delete anchor point, and convert point tools)	Option-click + tool (except add anchor point, delete anchor point, and convert point tools)
Move tool	V	V
Rectangular Marquee tool [†] Elliptical Marquee tool	M	M
Lasso tool Polygonal Lasso tool Magnetic Lasso tool	L	L
Magic Wand tool Quick Selection tool	W	W

Result	Windows	Mac OS
Crop tool Slice tool Slice Select tool	C	C
Eyedropper tool† Color Sampler tool Ruler tool Note tool Count tool*	I	I
Spot Healing Brush tool Healing Brush tool Patch tool Red Eye tool	J	J
Brush tool Pencil tool Color Replacement tool	B	B
Clone Stamp tool Pattern Stamp tool	S	S
History Brush tool Art History Brush tool	Y	Y
Eraser tool† Background Eraser tool Magic Eraser tool	E	E
Gradient tool Paint Bucket tool	G	G
Dodge tool Burn tool Sponge tool	O	O
Pen tool Freeform Pen tool	P	P
Horizontal Type tool Vertical Type tool Horizontal Type mask tool Vertical Type mask tool	T	T
Path Selection tool Direct Selection tool	A	A

Result	Windows	Mac OS
Rectangle tool Rounded Rectangle tool Ellipse tool Polygon tool Line tool Custom Shape tool	U	U
3D Rotate tool 3D Roll tool 3D Pan tool 3D Slide tool 3D Scale tool	K	K
3D Orbit tool 3D Roll View tool 3D Pan View tool 3D Walk View tool 3D Zoom tool	N	N
Hand tool [†]	H	H
Rotate View tool	R	R
Zoom tool [†]	Z	Z
[†] Use same shortcut keys for Extract, Liquify, and Pattern Maker [*] Photoshop Extended only		

Keys for selecting tools in the Extract toolbox

Result	Windows	Mac OS
Edge Highlighter tool	B	B
Fill tool	G	G
Eyedropper tool	I	I
Cleanup tool	C	C
Edge Touchup tool	T	T

Keys for selecting tools in the Liquify toolbox

Result	Windows	Mac OS
Forward Warp tool	W	W
Reconstruct tool	R	R
Twirl Clockwise tool	C	C

Result	Windows	Mac OS
Pucker tool	S	S
Bloat tool	B	B
Push Left tool	O	O
Mirror tool	M	M
Turbulence tool	T	T
Freeze Mask tool	F	F
Thaw Mask tool	D	D

Keys for working with Extract, Liquify, and Pattern Maker

Result (Extract, Liquify, and Pattern Maker)	Windows	Mac OS
Cycle through controls on right from top	Tab	Tab
Cycle through controls on right from bottom	Shift + Tab	Shift + Tab
Temporarily activate Hand tool	Spacebar	Spacebar
Change Cancel to Reset	Alt	Option

Result (Extract and Liquify)	Windows	Mac OS
Decreases or increases brush size] or [] or [

Result (Extract and Pattern Maker)	Windows	Mac OS
Fit in window	Control + 0	Command + 0
Zoom in	Control ++ (plus)	Command ++ (plus)
Zoom out	Control + - (hyphen)	Command + - (hyphen)

Result (Extract only)	Windows	Mac OS
Toggle between Edge Highlighter tool and Eraser tool	Alt + Edge Highlighter/Eraser tool	Option + Edge Highlighter/Eraser tool
Toggle Smart Highlighting	Control with Edge Highlighter tool selected	Command with Edge Highlighter tool selected
Remove current highlight	Alt + Delete	Option + Delete
Highlight entire image	Control + Delete	Command + Delete
Fill foreground area and preview extraction	Shift-click with Fill tool selected	Shift-click with Fill tool selected
Move mask when Edge Touchup tool is selected	Control-drag	Command-drag
Add opacity when Cleanup tool is selected	Alt-drag	Option-drag
Toggle Show menu options in preview between Original and Extracted	X	X

Result (Extract only)	Windows	Mac OS
Enable Cleanup and Edge Touchup tools before preview	Shift + X	Shift + X
Cycle through Display menu in preview from top to bottom	F	F
Cycle through Display menu in preview from bottom to top	Shift + F	Shift + F
Decrease/increase brush size by 1	Down Arrow/Up Arrow in Brush Size text box [†]	Down Arrow or Up Arrow in Brush Size text box [†]
Decrease/increase brush size by 1	Left Arrow/Right Arrow with Brush Size Slider showing [†]	Left Arrow/Right Arrow with Brush Size Slider showing [†]
Set strength of Cleanup or Edge Touch-up tool	0–9	0–9
[†] Hold down Shift to decrease/increase by 10		

Result (Liquify only)	Windows	Mac OS
Reverse direction for Bloat, Pucker, Push Left, and Mirror tools	Alt + tool	Option + tool
Continually sample the distortion	Alt-drag in preview with Reconstruct tool, Displace, Amplitwist, or Affine mode selected	Option-drag in preview with reconstruct tool, Displace, Amplitwist, or Affine mode selected
Decrease/increase brush size by 2, or density, pressure, rate, or turbulent jitter by 1	Down Arrow/Up Arrow in Brush Size, Density, Pressure, Rate, or Turbulent Jitter text box [†]	Down Arrow/Up Arrow in Brush Size, Density, Pressure, Rate, or Turbulent Jittertext box [†]
Decrease/increase brush size by 2, or density, pressure, rate, or turbulent jitter by 1	Left Arrow/Right Arrow with Brush Size, Density, Pressure, Rate, or Turbulent Jitter slider showing [†]	Left Arrow/Right Arrow with Brush Size, Density, Pressure, Rate, or Turbulent Jitter slider showing [†]
Redo last step	Control + Z	Command + Z
[†] Hold down Shift to decrease/increase by 10		

Result (Pattern Maker only)	Windows	Mac OS
Delete current selection	Control + D	Command + D
Undo a selection move	Control + Z	Command + Z
Generate or generate again	Control + G	Command + G
Intersect with current selection	Shift + Alt + select	Shift + Option + select
Toggle view: original/generated pattern	X	X
Go to first tile in Tile History	Home	Home
Go to last tile in Tile History	End	End
Go to previous tile in Tile History	Left Arrow, Page Up	Left Arrow, Page Up
Go to next tile in Tile History	Right Arrow, Page Down	Right Arrow, Page Down

Result (Pattern Maker only)	Windows	Mac OS
Delete current tile from Tile History	Delete	Delete
Nudge selection when viewing the original	Right Arrow, Left Arrow, Up Arrow, or Down Arrow	Right Arrow, Left Arrow, Up Arrow, or Down Arrow
Increase selection nudging when viewing the original	Shift + Right Arrow, Left Arrow, Up Arrow, or Down Arrow	Shift + Right Arrow, Left Arrow, Up Arrow, or Down Arrow

Keys for using the Filter Gallery

Result	Windows	Mac OS
Apply a new filter on top of selected	Alt-click a filter	Option-click a filter
Open/close all disclosure triangles	Alt-click a disclosure triangle	Option-click a disclosure triangle
Change Cancel button to Default	Control	Command
Change Cancel button to Reset	Alt	Option
Undo/Redo	Control + Z	Command + Z
Step forward	Control + Shift + Z	Command + Shift + Z
Step backward	Control + Alt + Z	Command + Option + Z

Keys for using the Refine Edge dialog box

Result	Windows	Mac OS
Open the Refine Edge dialog box	Control + Alt + R	Command + Option + R
Cycle (forward) through preview modes	F	F
Cycle (backward) through preview modes	Shift + F	Shift + F
Toggle between original image and selection preview	X	X
Toggle the preview option (on and off)	P	P

Keys for using the Black-and-White dialog box

Result	Windows	Mac OS
Open the Black-and-White dialog box	Shift + Control + Alt + B	Shift + Command + Option + B
Increase/decrease selected value by 1%	Up Arrow/Down Arrow	Up Arrow/Down Arrow
Increase/decrease selected value by 10%	Shift + Up Arrow/Down Arrow	Shift + Up Arrow/Down Arrow
Change the values of the closest color slider	Click-drag on the image	Click-drag on the image

Keys for using the Camera Raw dialog box

Note: Holding down a key temporarily activates a tool. Letting go of the key returns to the previous tool.

Result	Windows	Mac OS
Zoom tool	Z	Z
Hand tool	H	H
White Balance tool	I	I
Color Sampler tool	S	S
Crop tool	C	C
Straighten tool	A	A
Spot Removal tool	B	B
Red Eye Removal tool	E	E
Adjustment Brush tool	K	K
Graduated Filter tool	G	G
Resize brush	Ctrl-drag	Command-drag
Adjust feather	Ctrl + Shift-drag	Command + Shift-drag
Temporarily switch to erase mode for the Adjustment Brush tool, or switch to edit if in erase mode for the Adjustment Brush tool	Alt	Option
Switch to new adjustment if in edit or erase mode of the Adjustment Brush tool or the Graduated Filter	N	N
Toggle auto mask	M	M
Toggle mask	Y	Y
Toggle pins for Adjustment Brush tool	V	V
Toggle overlay for Graduated Filter, Spot Removal tool, or Red Eye Removal tool.	V	V
Rotate image left	L	L
Rotate image right	R	R
Zoom in	Control ++ (plus)	Command ++ (plus)
Zoom out	Control +- (hyphen)	Command +- (hyphen)
Temporarily switch to Zoom In tool (Doesn't work when Straighten tool is selected. If Crop tool is active, temporarily switches to Straighten tool.)	Control	Command
Temporarily switch to Zoom Out tool and change the Open Image button to Open Copy and the Cancel button to Reset.	Alt	Option
Toggle preview	P	P
Full screen mode	F	F

Result	Windows	Mac OS
Temporarily activate the White Balance tool and change the Open Image button to Open Object. (Does not work if Crop tool is active.)	Shift	Shift
Select multiple points in Curves panel	Click the first point; Shift-click additional points	Click the first point; Shift-click additional points
Add point to curve in Curves panel	Control-click in preview	Command-click in preview
Move selected point in Curves panel (1 unit)	Arrow keys	Arrow keys
Move selected point in Curves panel (10 units)	Shift-arrow	Shift-arrow
Open selected images in Camera Raw dialog box from Bridge	Control + R	Command + R
Open selected images from Bridge bypassing Camera Raw dialog box	Shift + double-click image	Shift + double-click image
Display highlights that will be clipped in Preview	Alt-drag Exposure, Recovery, or Black sliders	Option-drag Exposure, Recovery, or Black sliders
Highlight clipping warning	O	O
Shadows clipping warning	U	U
Context menu (Does not work in brushed adjustment)	Right-click	Control-click
Camera Raw preferences	Ctrl + K	Command + K
Deletes Adobe Camera Raw preferences	Ctrl + Alt (on open)	Option + Shift (on open)

Keys for using the Curves dialog box

Result	Windows	Mac OS
Open the Curves dialog box	Control + M	Command + M
Select next point on the curve	+ (plus)	+ (plus)
Select the previous point on the curve	- (minus)	- (minus)
Select multiple points on the curve	Shift-click the points	Shift-click the points
Deselect a point	Control + D	Command + D
To delete a point on the curve	Select a point and press Delete	Select a point and press Delete.
Move the selected point 1 unit	Arrow keys	Arrow keys
Move the selected point 10 units	Shift + Arrow keys	Shift + Arrow keys
Display highlights and shadows that will be clipped	Alt-drag black/white point sliders	Option-drag black/white point sliders
Set a point to the composite curve	Control-click the image	Command-click the image
Set a point to the channel curves	Shift + Control-click the image	Shift + Command-click the image
Toggle grid size	Alt-click the field	Option-click the field

Keys for using Vanishing Point

Result	Windows	Mac OS
Zoom tool	Z	Z
Zoom 2x (temporary)	X	X
Hand tool	H	H
Switch to Hand tool (temporary)	Spacebar	Spacebar
Zoom in	Control ++ (plus)	Command ++ (plus)
Zoom out	Control +- (hyphen)	Command +- (hyphen)
Fit in view	Control + 0 (zero), Double-click Hand tool	Command + 0 (zero), Double-click Hand tool
Zoom to center at 100%	Double-click Zoom tool	Double-click Zoom tool
Increase brush size (Brush, Stamp tools)]]
Decrease brush size (Brush, Stamp tools)	[[
Increase brush hardness (Brush, Stamp tools)	Shift +]	Shift +]
Decrease brush hardness (Brush, Stamp tools)	Shift + [Shift + [
Undo last action	Control + Z	Command + Z
Redo last action	Control + Shift + Z	Command + Shift + Z
Deselect all	Control + D	Command + D
Hide selection and planes	Control + H	Command + H
Move selection 1 pixel	Arrow keys	Arrow keys
Move selection 10 pixels	Shift + arrow keys	Shift + arrow keys
Copy	Control + C	Command + C
Paste	Control + V	Command + V
Repeat last duplicate and move	Control + Shift + T	Command + Shift + T
Create a floating selection from the current selection	Control + Alt + T	
Fill a selection with image under the pointer	Control-drag	Command-drag
Create a duplicate of the selection as a floating selection	Control + Alt-drag	Command + Option-drag
Constrain selection to a 15° rotation	Alt + Shift to rotate	Option + Shift to rotate
Select a plane under another selected plane	Control-click the plane	Command-click the plane
Create 90 degree plane off parent plane	Control-drag	Command-drag
Delete last node while creating plane	Backspace	Delete
Make a full canvas plane, square to the camera	Double-click the Create Plane tool	Double-click the Create Plane tool

Result	Windows	Mac OS
Show/hide measurements (Photoshop Extended only)	Control + Shift + H	Command + Shift + H
Export to a DFX file (Photoshop Extended only)	Control + E	Command + E
Export to a 3DS file (Photoshop Extended only)	Control + Shift + E	Command + Shift + E

Keys for working with blending modes

Result	Windows	Mac OS
Cycle through blending modes	Shift + + (plus) or - (minus)	Shift + + (plus) or - (minus)
Normal	Shift + Alt + N	Shift + Option + N
Dissolve	Shift + Alt + I	Shift + Option + I
Behind (Brush tool only)	Shift + Alt + Q	Shift + Option + Q
Clear (Brush tool only)	Shift + Alt + R	Shift + Option + R
Darken	Shift + Alt + K	Shift + Option + K
Multiply	Shift + Alt + M	Shift + Option + M
Color Burn	Shift + Alt + B	Shift + Option + B
Linear Burn	Shift + Alt + A	Shift + Option + A
Lighten	Shift + Alt + G	Shift + Option + G
Screen	Shift + Alt + S	Shift + Option + S
Color Dodge	Shift + Alt + D	Shift + Option + D
Linear Dodge	Shift + Alt + W	Shift + Option + W
Overlay	Shift + Alt + O	Shift + Option + O
Soft Light	Shift + Alt + F	Shift + Option + F
Hard Light	Shift + Alt + H	Shift + Option + H
Vivid Light	Shift + Alt + V	Shift + Option + V
Linear Light	Shift + Alt + J	Shift + Option + J
Pin Light	Shift + Alt + Z	Shift + Option + Z
Hard Mix	Shift + Alt + L	Shift + Option + L
Difference	Shift + Alt + E	Shift + Option + E
Exclusion	Shift + Alt + X	Shift + Option + X
Hue	Shift + Alt + U	Shift + Option + U
Saturation	Shift + Alt + T	Shift + Option + T
Color	Shift + Alt + C	Shift + Option + C
Luminosity	Shift + Alt + Y	Shift + Option + Y

Result	Windows	Mac OS
Desaturate	Sponge tool + Shift + Alt + D	Sponge tool + Shift + Option + D
Saturate	Sponge tool + Shift + Alt + S	Sponge tool + Shift + Option + S
Dodge/burn shadows	Dodge tool/Burn tool + Shift + Alt + S	Dodge tool/Burn tool + Shift + Option + S
Dodge/burn midtones	Dodge tool/Burn tool + Shift + Alt + M	Dodge tool/Burn tool + Shift + Option + M
Dodge/burn highlights	Dodge tool/Burn tool + Shift + Alt + H	Dodge tool/Burn tool + Shift + Option + H
Set blending mode to Threshold for bitmap images, Normal for all other images	Shift + Alt + N	Shift + Option + N

Keys for viewing images

This is not a complete list of keyboard shortcuts. This table lists only those shortcuts that are not displayed in menu commands or tool tips.

Result	Windows	Mac OS
Cycles through open documents	Control + Tab	Control + Tab
Close a file in Photoshop and open Bridge	Shift-Control-W	Shift-Command-W
Toggle between Standard mode and Quick Mask mode	Q	Q
Toggle (forward) between Standard screen mode, Maximized screen mode, Full screen mode, and Full screen mode with menu bar	F	F
Toggle (backward) between Standard screen mode, Maximized screen mode, Full screen mode, and Full screen mode with menu bar	Shift + F	Shift + F
Toggle (forward) canvas color	Space + F (or right-click canvas background and select color)	Space + F (or Control-click canvas background and select color)
Toggle (backward) canvas color	Space + Shift + F	Space + Shift + F
Fit image in window	Double-click Hand tool	Double-click Hand tool
Magnify 100%	Double-click Zoom tool	Double-click Zoom tool
Switch to Hand tool (when not in text-edit mode)	Spacebar	Spacebar
Simultaneously pan multiple documents simultaneously with Hand tool	Shift-drag	Shift-drag
Switch to Zoom In tool	Control + spacebar	Command + spacebar
Switch to Zoom Out tool	Alt + spacebar	Option + spacebar
Move Zoom marquee while dragging with the Zoom tool	Spacebar-drag	Spacebar-drag
Apply zoom percentage, and keep zoom percentage box active	Shift + Enter in Navigator panel zoom percentage box	Shift + Return in Navigator panel zoom percentage box
Zoom in on specified area of an image	Control-drag over preview in Navigator panel	Command-drag over preview in Navigator panel

Result	Windows	Mac OS
Temporarily zoom into an image	Hold down H and then click in the image and hold down the mouse button	Hold down H and then click in the image and hold down the mouse button
Scroll image with Hand tool	Spacebar-drag, or drag view area box in Navigator panel	Spacebar-drag, or drag view area box in Navigator panel
Scroll up or down 1 screen	Page Up or Page Down [†]	Page Up or Page Down [†]
Scroll up or down 10 units	Shift + Page Up or Page Down [†]	Shift + Page Up or Page Down [†]
Move view to upper-left corner or lower right corner	Home or End	Home or End
Toggle layer mask on/off as rbylith (layer mask must be selected)	\ (backslash)	\ (backslash)
[†] Hold down Ctrl (Windows) or Command (Mac OS) to scroll left (Page Up) or right (Page Down)		

Keys for selecting and moving objects

This is not a complete list of keyboard shortcuts. This table lists only those shortcuts that are not displayed in menu commands or tool tips.

Result	Windows	Mac OS
Reposition marquee while selecting [‡]	Any marquee tool (except single column and single row) + spacebar-drag	Any marquee tool (except single column and single row) + spacebar-drag
Add to a selection	Any selection tool + Shift-drag	Any selection tool + Shift-drag
Subtract from a selection	Any selection tool + Alt-drag	Any selection tool + Option-drag
Intersect a selection	Any selection tool (except Quick Selection tool) + Shift-Alt-drag	Any selection tool (except Quick Selection tool) + Shift-Option-drag
Constrain marquee to square or circle (if no other selections are active) [‡]	Shift-drag	Shift-drag
Draw marquee from center (if no other selections are active) [‡]	Alt-drag	Option-drag
Constrain shape and draw marquee from center [‡]	Shift + Alt-drag	Shift + Option-drag
Switch to Move tool	Control (except when Hand, Slice, Path, Shape, or any Pen tool is selected)	Command (except when Hand, Slice, Path, Shape, or any Pen tool is selected)
Switch from Magnetic Lasso tool to Lasso tool	Alt-drag	Option-drag
Switch from Magnetic Lasso tool to polygonal Lasso tool	Alt-click	Option-click
Apply/cancel an operation of the Magnetic Lasso	Enter/Esc or Control + . (period)	Return/Esc or Command + . (period)
Move copy of selection	Move tool + Alt-drag selection [‡]	Move tool + Option-drag selection [‡]
Move selection area 1 pixel	Any selection + Right Arrow, Left Arrow, Up Arrow, or Down Arrow [†]	Any selection + Right Arrow, Left Arrow, Up Arrow, or Down Arrow [†]
Move selection 1 pixel	Move tool + Right Arrow, Left Arrow, Up Arrow, or Down Arrow ^{†‡}	Move tool + Right Arrow, Left Arrow, Up Arrow, or Down Arrow ^{†‡}

Result	Windows	Mac OS
Move layer 1 pixel when nothing selected on layer	Control + Right Arrow, Left Arrow, Up Arrow, or Down Arrow [†]	Command + Right Arrow, Left Arrow, Up Arrow, or Down Arrow [†]
Increase/decrease detection width	Magnetic Lasso tool + [or]	Magnetic Lasso tool + [or]
Accept cropping or exit cropping	Crop tool + Enter or Esc	Crop tool + Return or Esc
Toggle crop shield off and on	/ (forward slash)	/ (forward slash)
Make protractor	Ruler tool + Alt-drag end point	Ruler tool + Option-drag end point
Snap guide to ruler ticks (except when View > Snap is unchecked)	Shift-drag guide	Shift-drag guide
Convert between horizontal and vertical guide	Alt-drag guide	Option-drag guide
[†] Hold down Shift to move 10 pixels [‡] Applies to shape tools		

Keys for editing paths

This is not a complete list of keyboard shortcuts. This table lists only those shortcuts that are not displayed in menu commands or tool tips.

Result	Windows	Mac OS
Select multiple anchor points	Direct selection tool + Shift-click	Direct selection tool + Shift-click
Select entire path	Direct selection tool + Alt-click	Direct selection tool + Option-click
Duplicate a path	Pen (any Pen tool), Path Selection or Direct Selection tool + Control + Alt-drag	Pen (any Pen tool), Path Selection or Direct Selection tool + Command + Option-drag
Switch from Path Selection, Pen, Add Anchor Point, Delete Anchor Point, or Convert Point tools, to Direct Selection tool	Control	Command
Switch from Pen tool or Freeform Pen tool to Convert Point tool when pointer is over anchor or direction point	Alt	Option
Close path	Magnetic Pen tool-double-click	Magnetic Pen tool-double-click
Close path with straight-line segment	Magnetic Pen tool + Alt-double-click	Magnetic Pen tool + Option-double-click

Keys for painting objects

This is not a complete list of keyboard shortcuts. This table lists only those shortcuts that are not displayed in menu commands or tool tips.

Result	Windows	Mac OS
Eyedropper tool	Any painting tool + Alt or any shape tool + Alt (except when Paths option is selected)	Any painting tool + Option or any shape tool + Option (except when Paths option is selected)
Select background color	Eyedropper tool + Alt-click	Eyedropper tool + Option-click
Color sampler tool	Eyedropper tool + Shift	Eyedropper tool + Shift

Result	Windows	Mac OS
Deletes color sampler	Color sampler tool + Alt-click	Color sampler tool + Option-click
Sets opacity, tolerance, strength, or exposure for painting mode	Any painting or editing tool + number keys (e.g., 0 = 100%, 1 = 10%, 4 then 5 in quick succession = 45%) (When airbrush option is enabled, use Shift + number keys)	Any painting or editing tool + number keys (e.g., 0 = 100%, 1 = 10%, 4 then 5 in quick succession = 45%) (When airbrush option is enabled, use Shift + number keys)
Sets flow for painting mode	Any painting or editing tool + Shift + number keys (e.g., 0 = 100%, 1 = 10%, 4 then 5 in quick succession = 45%) (When airbrush option is enabled, omit Shift)	Any painting or editing tool + Shift + number keys (e.g., 0 = 100%, 1 = 10%, 4 then 5 in quick succession = 45%) (When airbrush option is enabled, omit Shift)
Cycles through blending modes	Shift + + (plus) or – (minus)	Shift + + (plus) or – (minus)
Fills selection/layer with foreground or background color	Alt + Backspace, or Control + Backspace [†]	Option + Delete, or Command + Delete [†]
Fills from history	Control + Alt + Backspace [†]	Command + Option + Delete [†]
Displays Fill dialog box	Shift + Backspace	Shift + Delete
Lock transparent pixels on/off	/ (forward slash)	/ (forward slash)
Connects points with a straight line	Any painting tool + Shift-click	Any painting tool + Shift-click
[†] Hold down Shift to preserve transparency		

Keys for transforming selections, selection borders, and paths

This is not a complete list of keyboard shortcuts. This table lists only those shortcuts that are not displayed in menu commands or tool tips.

Result	Windows	Mac OS
Transform from center or reflect	Alt	Option
Constrain	Shift	Shift
Distort	Control	Command
Apply	Enter	Return
Cancel	Control + . (period) or Esc	Command + . (period) or Esc
Free transform with duplicate data	Control + Alt + T	Command + Option + T
Transform again with duplicate data	Control + Shift + Alt + T	Command + Shift + Option + T

Keys for selecting, editing, and navigating through text

This is not a complete list of keyboard shortcuts. This table lists only those shortcuts that are not displayed in menu commands or tool tips.

Result	Windows	Mac OS
Move type in image	Control-drag type when Type layer is selected	Command-drag type when Type layer is selected
Select 1 character left/right or 1 line down/up, or 1 word left/right	Shift + Left Arrow/Right Arrow or Down Arrow/Up Arrow, or Control + Shift + Left Arrow/Right Arrow	Shift + Left Arrow/Right Arrow or Down Arrow/Up Arrow, or Command + Shift + Left Arrow/Right Arrow
Select characters from insertion point to mouse click point	Shift-click	Shift-click
Move 1 character left/right, 1 line down/up, or 1 word left/right	Left Arrow/Right Arrow, Down Arrow/Up Arrow, or Control + Left Arrow/Right Arrow	Left Arrow/Right Arrow, Down Arrow/Up Arrow, or Command + Left Arrow/Right Arrow
Create a new text layer, when a text layer is selected in the Layers panel	Shift-click	Shift-click
Select a word, line, paragraph, or story	Double-click, triple-click, quadruple-click, or quintuple-click	Double-click, triple-click, quadruple-click, or quintuple-click
Show/Hide selection on selected type	Control + H	Command + H
Display the bounding box for transforming text when editing text, or activate Move tool if cursor is inside the bounding box	Control	Command
Scale text within a bounding box when resizing the bounding box	Control-drag a bounding box handle	Command-drag a bounding box handle
Move text box while creating text box	Spacebar-drag	Spacebar-drag

Keys for formatting type

This is not a complete list of keyboard shortcuts. This table lists only those shortcuts that are not displayed in menu commands or tool tips.

Result	Windows	Mac OS
Align left, center, or right	Horizontal Type tool + Control + Shift + L, C, or R	Horizontal Type tool + Command + Shift + L, C, or R
Align top, center, or bottom	Vertical Type tool + Control + Shift + L, C, or R	Vertical Type tool + Command + Shift + L, C, or R
Choose 100% horizontal scale	Control + Shift + X	Command + Shift + X
Choose 100% vertical scale	Control + Shift + Alt + X	Command + Shift + Option + X
Choose Auto leading	Control + Shift + Alt + A	Command + Shift + Option + A
Choose 0 for tracking	Control + Shift + Q	Command + Control + Shift + Q
Justify paragraph, left aligns last line	Control + Shift + J	Command + Shift + J
Justify paragraph, justifies all	Control + Shift + F	Command + Shift + F
Toggle paragraph hyphenation on/off	Control + Shift + Alt + H	Command + Control + Shift + Option + H
Toggle single/every-line composer on/off	Control + Shift + Alt + T	Command + Shift + Option + T
Decrease or increase type size of selected text 2 points or pixels	Control + Shift + < or >†	Command + Shift + < or >†

Result	Windows	Mac OS
Decrease or increase leading 2 points or pixels	Alt + Down Arrow or Up Arrow ^{††}	Option + Down Arrow or Up Arrow ^{††}
Decrease or increase baseline shift 2 points or pixels	Shift + Alt + Down Arrow or Up Arrow ^{††}	Shift + Option + Down Arrow or Up Arrow ^{††}
Decrease or increase kerning/tracking 20/1000 ems	Alt + Left Arrow or Right Arrow ^{††}	Option + Left Arrow or Right Arrow ^{††}
[†] Hold down Alt (Win) or Option (Mac OS) to decrease/increase by 10 ^{††} Hold down Ctrl (Windows) or Command (Mac OS) to decrease/increase by 10		

Keys for slicing and optimizing

Result	Windows	Mac OS
Toggle between Slice tool and Slice Selection tool	Control	Command
Draw square slice	Shift-drag	Shift-drag
Draw from center outward	Alt-drag	Option-drag
Draw square slice from center outward	Shift + Alt-drag	Shift + Option-drag
Reposition slice while creating slice	Spacebar-drag	Spacebar-drag
Open context-sensitive menu	Right-click slice	Control-click slice

Keys for using panels

This is not a complete list of keyboard shortcuts. This table lists only those shortcuts that are not displayed in menu commands or tool tips.

Result	Windows	Mac OS
Set options (except for Actions, Animation, Styles, Brushes, Tool Presets, and Layer Comps panels)	Alt-click New button	Option-click New button
Delete without confirmation (except for the Brushes panel)	Alt-click Delete button	Option-click Delete button
Apply value and keep text box active	Shift + Enter	Shift + Return
Load as a selection	Control-click channel, layer, or path thumbnail.	Command-click channel, layer, or path thumbnail.
Add to current selection	Control + Shift-click channel, layer, or path thumbnail.	Command + Shift-click channel, layer, or path thumbnail.
Subtract from current selection	Control + Alt-click channel, path, or layer thumbnail.	Command + Option-click channel, path, or layer thumbnail.
Intersect with current selection	Control + Shift + Alt-click channel, path, or layer thumbnail.	Command + Shift + Option-click channel, path, or layer thumbnail.
Show/Hide all panels	Tab	Tab

Result	Windows	Mac OS
Show/Hide all panels except the toolbox and options bar	Shift + Tab	Shift + Tab
Highlight options bar	Select tool and press Enter	Select tool and press Return
Increase/decrease units by 10 in a pop-up menu	Shift + Up Arrow/Down Arrow	Shift + Up Arrow/Down Arrow

Keys for using the Actions panel

Result	Windows	Mac OS
Turn command on and all others off, or turns all commands on	Alt-click the check mark next to a command.	Option-click the check mark next to a command.
Turn current modal control on and toggle all other modal controls	Alt-click	Option-click
Change action or action set options	Alt + double-click action or action set	Option + double-click action or action set
Display Options dialog box for recorded command	Double-click recorded command	Double-click recorded command
Play entire action	Control + double-click an action	Command + double-click an action
Collapse/expand all components of an action	Alt-click the triangle	Option-click the triangle
Play a command	Control-click the Play button	Command-click the Play button
Create new action and begin recording without confirmation	Alt-click the New Action button	Option-click the New Action button
Select contiguous items of the same kind	Shift-click the action/command	Shift-click the action/command
Select discontinuous items of the same kind	Control-click the action/command	Command-click the action/command

Keys for using the Adjustments panel

Result	Windows	Mac OS
Choose a channel for adjustment	Alt + 3 (red), 4 (green), 5 (blue)	Option + 3 (red), 4 (green), 5 (blue)
Select individual channels in the Channels panel	Ctrl + 3 (red), 4 (green), 5 (blue)	Command + 3 (red), 4 (green), 5 (blue)
Load individual channel as selection	Alt + Ctrl + 3 (red), 4 (green), 5 (blue)	Option + Command + 3 (red), 4 (green), 5 (blue)
Choose composite channel for adjustment	Alt + 2	Option + 2
Select composite channel in Channel panel	Ctrl + 2	Command + 2
Toggle layer or smart filter masks	\ (backslash)	\ (backslash)
Temporarily view the state of previous adjustment layer	Hold down \ (backslash)	
Select next/previous point on curve (for Curves adjustment)	= (equal) / - (minus)	= (equal) / - (minus)
100% view	Ctrl + 1	Command + 1

Result	Windows	Mac OS
Switch to next document	Ctrl + Tab	Command + `
Switch to previous document	Shift + Control + Tab	Shift + Command + `
Delete layer	Delete or Backspace	Delete

Keys for using the Animation panel

Result	Windows	Mac OS
Select/deselect multiple contiguous frames	Shift-click second frame	Shift-click second frame
Select/deselect multiple discontinuous frames	Control-click multiple frames	Command-click multiple frames
Paste using previous settings without displaying the dialog box	Alt + Paste Frames command from the Panel pop-up menu	Option + Paste Frames command from the Panel pop-up menu

Keys for using the Animation panel in Timeline Mode (Photoshop Extended)

Note: Some shortcuts need to be enabled. Choose Enable Timeline Shortcut Keys from the Animation (Timeline) panel menu.

Result	Windows	Mac OS
Start playing the timeline or Animation panel	Spacebar	Spacebar
Switch between timecode and frame numbers (current time view)	Alt + click the current-time display in the upper-left corner of the timeline.	Option + click the current-time display in the upper-left corner of the timeline.
Expand and collapse list of layers	Alt + click	Option + click on list triangles
Jump to the next/previous whole second in timeline	Hold down the Shift key when clicking the Next/Previous Frame buttons (on either side of the Play button).	Hold down the Shift key when clicking the Next/Previous Frame buttons (on either side of the Play button)
Increase playback speed	Hold down the Shift key while dragging the current time.	Hold down the Shift key while dragging the current time.
Decrease playback speed	Hold down the Control key while dragging the current time.	Hold down the Command key while dragging the current time.
Snap an object (keyframe, the current time, layer in point, and so on) to the nearest object in timeline	Shift-drag	Shift-drag
Scale (evenly distribute to condensed or extended length) a selected group of multiple keyframes	Alt-drag (first or last keyframe in the selection)	Option-drag (first or last keyframe in the group)
Back one frame	Left Arrow or Page Up	Left Arrow or Page Up
Forward one frame	Right Arrow or Page Down	Right Arrow or Page Down
Back ten frames	Shift + Left Arrow or Shift + Page Up	Shift + Left Arrow or Shift Page Up
Forward ten frames	Shift + Right Arrow or Shift + Page Down	Shift + Right Arrow or Shift + Page Down
Move to the beginning of the timeline	Home	Home
Move to the end of the timeline	End	End

Result	Windows	Mac OS
Move to the beginning of the work area	Shift + Home	Shift + Home
Move to the end of the work area	Shift + End	Shift + End
Move to In point of the current layer	Up Arrow	Up Arrow
Move to the Out point of the current layer	Down Arrow	Down Arrow
Back 1 second	Shift + Up Arrow	Shift + Up Arrow
Foward 1 second	Shift + Down Arrow	Shift + Down Arrow
Return a rotated document to its original orientation	Esc	Esc

Keys for using the Clone Source

Result	Windows	Mac OS
Show Clone Source (overlays image)	Alt + Shift	Opt + Shift
Nudge Clone Source	Alt + Shift + arrow keys	Opt + Shift + arrow keys
Rotate Clone Source	Alt + Shift + < or >	Opt + Shift + < or >
Scale (increase or reduce size) Clone Source	Alt + Shift + [or]	Opt + Shift + [or]

Keys for using the Brushes panel

Result	Windows	Mac OS
Delete brush	Alt-click brush	Option-click brush
Rename brush	Double-click brush	Double-click brush
Change brush size	Alt + right click + drag	Ctrl + Option + click-drag
Decrease/increase brush softness/hardness	Alt + Shift + right click + drag	Command + Ctrl + Option + click-drag
Select previous/next brush size	, (comma) or . (period)	, (comma) or . (period)
Select first/last brush	Shift + , (comma) or . (period)	Shift + , (comma) or . (period)
Display precise cross hair for brushes	Caps Lock or Shift + Caps Lock	Caps Lock
Toggle airbrush option	Shift + Alt + P	Shift + Option + P

Keys for using the Channels panel

Result	Windows	Mac OS
Set options for Save Selection As Channel button	Alt-click Save Selection As Channel button	Option-click Save Selection As Channel button
Create a new spot channel	Control-click Create New Channel button	Command-click Create New Channel button
Select/deselect multiple color-channel selection	Shift-click color channel	Shift-click color channel

Result	Windows	Mac OS
Select/deselect alpha channel and show/hide as a rubylith overlay	Shift-click alpha channel	Shift-click alpha channel
Display channel options	Double-click alpha or spot channel thumbnail	Double-click alpha or spot channel thumbnail
Toggle composite and grayscale mask in Quick Mask mode	~ (tilde)	~ (tilde)

Keys for using the Color panel

Result	Windows	Mac OS
Select background color	Alt-click color in color bar	Option-click color in color bar
Display Color Bar menu	Right-click color bar	Control-click color bar
Cycle through color choices	Shift-click color bar	Shift-click color bar

Keys for using the History panel

Result	Windows	Mac OS
Create a new snapshot	Alt + New Snapshot	Option + New Snapshot
Rename snapshot	Double-click snapshot name	Double-click snapshot name
Step forward through image states	Control + Shift + Z	Command + Shift + Z
Step backward through image states	Control + Alt + Z	Command + Option + Z
Duplicate any image state, except the current state	Alt-click the image state	Option-click the image state
Permanently clear history (no Undo)	Alt + Clear History (in History panel pop-up menu)	Option + Clear History (in History panel pop-up menu)

Keys for using the Info panel

Result	Windows	Mac OS
Change color readout modes	Click eyedropper icon	Click eyedropper icon
Change measurement units	Click crosshair icon	Click crosshair icon

Keys for using the Layer Comps panel

Result	Windows	Mac OS
Create new layer comp without the New Layer Comp box	Alt-click Create New Layer Comp button	Option-click Create New Layer Comp button
Open Layer Comp Options dialog box	Double-click layer comp	Double-click layer comp

Result	Windows	Mac OS
Rename in-line	Double-click layer comp name	Double-click layer comp name
Select/deselect multiple contiguous layer comps	Shift-click	Shift-click
Select/deselect multiple discontinuous layer comps	Control-click	Command-click

Keys for using the Layers panel

Result	Windows	Mac OS
Load layer transparency as a selection	Control-click layer thumbnail	Command-click layer thumbnail
Load filter mask as a selection	Control-click filter mask thumbnail	Command-click filter mask thumbnail
Group layers	Control + G	Command + G
Ungroup layers	Control + Shift + G	Command-Shift + G
Create/release clipping mask	Control + Alt + G	Command-Option + G
Select all layers	Control + Alt + A	Command + Option + A
Merge visible layers	Control + Shift + E	Command + Shift + E
Create new empty layer with dialog box	Alt-click New Layer button	Option-click New Layer button
Create new layer below target layer	Control-click New Layer button	Command-click New Layer button
Select top layer	Alt + . (period)	Option + . (period)
Select bottom layer	Alt + , (comma)	Option + , (comma)
Add to layer selection in Layers panel	Shift + Alt + [or]	Shift + Option + [or]
Select next layer down/up	Alt + [or]	Option + [or]
Move target layer down/up	Control + [or]	Command + [or]
Merge a copy of all visible layers into target layer	Control + Shift + Alt + E	Command + Shift + Option + E
Merge layers	Highlight layers you want to merge, then Control + E	Highlight the layers you want to merge, then Command + E
Move layer to bottom or top	Control + Shift + [or]	Command + Shift + [or]
Copy current layer to layer below	Alt + Merge Down command from the Panel pop-up menu	Option + Merge Down command from the Panel pop-up menu
Merge all visible layers to a new layer above the currently selected layer	Alt + Merge Visible command from the Panel pop-up menu	Option + Merge Visible command from the Panel pop-up menu
Show/hide this layer/layer group only or all layers/layer groups	Right-click the eye icon	Control-click the eye icon
Show/hide all other currently visible layers	Alt-click the eye icon	Option-click the eye icon
Toggle lock transparency for target layer, or last applied lock	/ (forward slash)	/ (forward slash)
Edit layer effect/style, options	Double-click layer effect/style	Double-click layer effect/style
Hide layer effect/style	Alt-double-click layer effect/style	Option-double-click layer effect/style

Result	Windows	Mac OS
Edit layer style	Double-click layer	Double-click layer
Disable/enable vector mask	Shift-click vector mask thumbnail	Shift-click vector mask thumbnail
Open Layer Mask Display Options dialog box	Double-click layer mask thumbnail	Double-click layer mask thumbnail
Toggle layer mask on/off	Shift-click layer mask thumbnail	Shift-click layer mask thumbnail
Toggle filter mask on/off	Shift-click filter mask thumbnail	Shift-click filter mask thumbnail
Toggle between layer mask/composite image	Alt-click layer mask thumbnail	Option-click layer mask thumbnail
Toggle between filter mask/composite image	Alt-click filter mask thumbnail	Option-click filter mask thumbnail
Toggle rubylith mode for layer mask on/off	\ (backslash), or Shift + Alt-click	\ (backslash), or Shift + Option-click
Select all type; temporarily select Type tool	Double-click type layer thumbnail	Double-click type layer thumbnail
Create a clipping mask	Alt-click the line dividing two layers	Option-click the line dividing two layers
Rename layer	Double-click the layer name	Double-click the layer name
Edit filter settings	Double-click the filter effect	Double-click the filter effect
Edit the Filter Blending options	Double-click the Filter Blending icon	Double-click the Filter Blending icon
Create new layer set below current layer/layer set	Control-click New Layer Set button	Command-click New Layer Set button
Create new layer set with dialog box	Alt-click New Layer Set button	Option-click New Layer Set button
Create layer mask that hides all/selection	Alt-click Add Layer Mask button	Option-click Add Layer Mask button
Create vector mask that reveals all/path area	Control-click Add Layer Mask button	Command-click Add Layer Mask button
Create vector mask that hides all or displays path area	Control + Alt-click Add Layer Mask button	Command + Option-click Add Layer Mask button
Display layer group properties	Right-click layer group and choose Group Properties, or double-click group	Control-click the layer group and choose Group Properties, or double-click group
Select/deselect multiple contiguous layers	Shift-click	Shift-click
Select/deselect multiple discontiguous layers	Control-click	Command-click

Keys for using the Paths panel

Result	Windows	Mac OS
Add path to selection	Control + Shift-click pathname	Command + Shift-click pathname
Subtract a path from selection	Control + Alt-click pathname	Command + Option-click pathname

Result	Windows	Mac OS
Retain intersection of path as a selection	Control + Shift + Alt-click pathname	Command + Shift + Option-click pathname
Hide path	Control + Shift + H	Command + Shift + H
Set options for Fill Path with Foreground Color button, Stroke Path with Brush button, Load Path as a Selection button, Make Work Path from Selection button, and Create New Path button	Alt-click button	Option-click button

Keys for using the Swatches panel

Result	Windows	Mac OS
Create new swatch from foreground color	Click in empty area of panel	Click in empty area of panel
Set swatch color as background color	Control-click swatch	Command-click swatch
Delete swatch	Alt-click swatch	Option-click swatch

Keys for using Measurement (Photoshop Extended)

Result	Windows	Mac OS
Record a measurement	Shift + Control + M	Shift + Command + M
Deselects all measurements	Control + D	Command + D
Selects all measurements	Control + A	Command + A
Hide/show all measurements	Shift + Control + H	Shift + Command + H
Removes a measurement	Backspace	Delete
Nudge the measurement	Arrow keys	Arrow keys
Nudge the measurement in increments	Shift + arrow keys	Shift + arrow keys
Extend/shorten selected measurement	Ctrl + left/right arrow key	Command + left/right arrow key
Extend/shorten selected measurement in increments	Shift + Ctrl + left/right arrow key	Shift + Command + left/right arrow key
Rotate selected measurement	Ctrl + up/down arrow key	Command + up/down arrow key
Rotate selected measurement in increments	Shift + Ctrl + up/down arrow key	Shift + Command + up/down arrow key

Keys for using 3D tools (Photoshop Extended)

Result	Windows	Mac OS
Enable 3D object tools	K	K
Enable 3D camera tools	N	N
Hide nearest surface	Alt + Ctrl + X	Option + Command + X
Show all surfaces	Alt + Shift + Ctrl + X	Option + Shift + Command + X

3D Object Tool	Right-click (Windows) / Control-click (Mac OS)	Alt (Windows) / Option (Mac OS)
Rotate	Changes to Drag tool	Changes to Roll tool
Roll	Changes to Slide tool	Changes to Orbit tool
Drag	Changes to Orbit tool	Changes to Slide tool
Slide	Changes to Roll tool	Changes to Drag tool
Scale	Scales on the Z plane	L

Camera Tool	Right-click (Windows) / Control-click (Mac OS)	Alt (Windows) / Option (Mac OS)
Orbit	Changes to Drag tool	Changes to Roll tool
Roll	Changes to Slide tool	Changes to Rotate tool
Pan	Changes to Orbit tool	Changes to Slide tool
Walk	Changes to Roll tool	Changes to Drag tool

Keys for working with DICOM files (Photoshop Extended)

Result	Windows	Mac OS
Zoom tool	Z	Z
Hand tool	H	H
Window Level tool	W	W
Select all frames	Control + A	Command + A
Deselect all frames except the current frame	Control + D	Command + D
Navigate through frames	Arrow keys	Arrow keys

Function keys

Result	Windows	Mac OS
Start Help	F1	Help key
Undo/Redo		F1
Cut	F2	F2
Copy	F3	F3
Paste	F4	F4
Show/Hide Brushes panel	F5	F5
Show/Hide Color panel	F6	F6
Show/Hide Layers panel	F7	F7
Show/Hide Info panel	F8	F8
Show/Hide Actions panel	F9	Option + F9

Result	Windows	Mac OS
Revert	F12	F12
Fill	Shift + F5	Shift + F5
Feather Selection	Shift + F6	Shift + F6
Inverse Selection	Shift + F7	Shift + F7

Index

Numerics

- 16 bpc images 56
- 32 bpc images 75
- 360 degree panoramas 245
- 3D files
 - about 571
 - formats 571
 - opening 572
 - rendering 596
- 3D layers
 - combining with 2D layers 592
 - converting to Smart Objects 593
 - exporting and saving 597
 - merging objects 591
 - rasterizing 593
- 3D models
 - animating 592
 - creating from 2D layers 590
 - painting 587
 - rendering 593
 - surfaces, hiding 587
 - textures 579, 584
- 3D panel
 - Lights settings 582
 - Materials section 579
 - Mesh settings 578
 - overview 575
 - Scene settings 577
- 3D tools
 - axis 574
 - camera and object 572
- 8 bpc images 56

A

- Accented Edges filter 391
- Acrobat. *See* Adobe Acrobat
- action playback speed 615
- action sets 617
- actions
 - about 614
 - changing recorded values in 620
 - deleting 616
 - duplicating 616
 - editing 621
 - excluding tasks from 620

- inserting stops in 619
 - loading 617
 - playing 615
 - processing files with droplets 624
 - rearranging 616
 - recording 618
 - recording again 621
 - renaming 616
 - selecting 615
 - undoing 615
- Actions panel
 - about 614
 - keyboard shortcuts for 665
- activation of software 1
- active layer 284
- Actual Pixels view 30
- Actual Size view 30
- Adaptive color palette 112
- Add Noise filter 392
- Add option 277
- adjustment layers
 - about 158, 307
 - creating 308
 - editing 309
 - merging 309
- Adobe Acrobat
 - comparing versions 447
 - presets for exporting to 445
- Adobe After Effects
 - importing Photoshop (PSD) files into 536
- Adobe Bridge
 - about 14
 - Creative Suite color settings 128, 130
 - metadata in 464
- Adobe Color Picker
 - alerts 119
 - choosing 120
 - choosing a custom color with 119
 - displaying 117
 - out-of-gamut alert in 116, 117
 - selecting a CMYK color with 118
 - selecting web-safe colors with 118
 - specifying a hexadecimal color in 118
 - specifying a Lab color with 118
- Adobe ConnectNow 52

- Adobe Exchange 3
- Adobe Illustrator
 - files, opening 66, 68
 - importing art from by placing 65
 - metadata in 464
 - using Photoshop files in 469
- Adobe InDesign
 - metadata in 464
- Adobe PDF conversion settings 445
- Adobe PDF presets. *See* PDF files
- Adobe Photoshop
 - See also* Photoshop format, Photoshop PDF format, Photoshop RAW format
 - legacy serial number 44
 - metadata in 464
 - testing mobile content created in 443
 - using with Device Central 443
- Adobe Photoshop EPS format. *See* EPS files
- Adobe Premiere Pro 460
- Adobe Product Improvement Program 1
- Adobe RGB color space 145
- airbrush 345
- alert messages, hiding and showing 44
- Align Layers command 287
- Align To Selection command 287
- aligning
 - layers 287
 - selections 248
 - shapes 378
 - slices 503
- Alignment buttons 287
- alignment. *See* aligning
- All Caps command 415
- All Channels View of Histogram panel 150
- Allow Non-Linear History option 49
- alpha channel interpretation 539
- alpha channels
 - See also* channels
 - about 265
 - adding texture with 403
 - calculating 276
 - converting to spot channel 492
 - creating 273
 - deleting 269
 - file formats for saving 265
 - file size of 265

- loading a saved selection from 275
 - options for 273
 - saving 441
 - saving selection in 274
 - ALT HTML element 505
 - alternate glyphs
 - OpenType fonts 418
 - anchor points
 - adding or deleting 378
 - converting 379
 - moving and nudging 374, 376
 - rules for adjusting 374
 - angle
 - brush option 338
 - global lighting 303
 - Angled Strokes filter 391
 - Angular Gradient tool 350
 - animated GIFs. *See* animations
 - animation frames
 - See also* animations
 - adding layers to 552
 - cloning content 541
 - copying and pasting 550
 - disposal method for 553
 - duplicating 530
 - editing 549
 - flattening into layers 564
 - tweening 551
 - Animation panel
 - about 529
 - modes 531
 - animations
 - See also* animation frames
 - about 529
 - adding frames to 548
 - creating 537
 - delay time 552
 - deleting 554
 - exporting 564
 - frame delay 552
 - looping 529, 553
 - optimizing 563
 - previewing 560
 - saving 563
 - timeline preview 561
 - annotations, in Save For Web 508
 - ANPA colors 119
 - anti-aliasing
 - Adobe Illustrator files 68
 - EPS files 68
 - layer styles 301
 - selections 259
 - type 408
 - in web graphics 511
 - Apple Color Picker 120
 - AppleScript 626
 - Apply Image command 276
 - arrowhead options 363
 - Art History Brush tool 330
 - Artistic filters 389
 - Asian type
 - about 434
 - aligning characters in 435
 - burasagari 439
 - formatting exceptions in 427
 - kinsoku shori 438
 - kumimoji 435
 - leading in 434
 - line breaking options for 439
 - mojikumi 437
 - OpenType font attributes 436
 - renmoji 435
 - setting options for 434
 - tate-chu-yoko 435
 - tsume 434
 - aspect ratio
 - in video images 533
 - of placed artwork 69
 - settings 562
 - Assign Profile command 142
 - Auto Color command
 - about 186, 187
 - options for 187
 - Auto Contrast command
 - about 186
 - options for 187
 - Auto Levels command
 - about 185, 187
 - clipping defaults 185
 - Auto Select Group option 286
 - Auto Select Layer option 286
 - auto slices. *See* slices
 - Auto Tone command 185
 - options for 187
 - Auto-Align Layers command 287, 327
 - Auto-Blend Layers command 289
 - automatic frame disposal 553
 - automating
 - batch processing 623
 - batches of data sets 630
 - saving templates for other Adobe applications 632
 - through scripting 626
 - using droplets 624
 - automating contact sheets 636
 - automation. *See* actions
 - Average Blur filter 390
- ## B
- background color
 - choosing 114, 121
 - editing with Color panel 121
 - filling selections with 355
 - web pages 526
 - Background Eraser tool 332
 - background images 526
 - backgrounds
 - converting 281
 - erasing 332
 - from filter effects 388
 - layer styles and 299, 300
 - badges 499
 - barrel distortion 206
 - Bas Relief filter 394
 - base
 - color (in blending modes) 346
 - layer 326
 - output size 476
 - baseline shift 422
 - Batch command 623
 - Batch processing 623, 624
 - batch processing options 625
 - Behind mode 347
 - Bevel And Emboss effect 300
 - Bilateral Blur filter 391
 - binary encoding, in EPS files 455
 - bit depth 55, 56
 - bitmap images
 - about 54
 - resolution of 55
 - transparency in 55
 - Bitmap mode
 - about 107, 109
 - converting to Grayscale 111
 - Custom Pattern option 110
 - Paint Bucket tool 354
 - using type 404
 - Black & White command 171
 - Black Body option 114
 - black point compensation 147

- black-and-white images, creating 190
 - Blend Clipped Layers As Group option 297
 - blend color 346
 - Blend Interior Effects As Group option 297
 - blending modes
 - about 346
 - choosing 294
 - for channel calculations 276, 277
 - for layer groups 294
 - blending options, advanced 296
 - blends
 - grouping effects 296
 - restricting to channels 296
 - specifying range for 298
 - Blur and Blur More filters 390
 - Blur tool 205
 - BMP file format
 - about 460
 - saving in 456
 - Border command 258
 - bottom-to-bottom leading 434
 - bounding boxes, of type 406
 - Box Blur filter 390
 - Bridge. *See* Adobe Bridge
 - brightness
 - adjusting 174
 - adjusting in Illustrator 8
 - equalizing 189
 - in HSB color model 105
 - Brightness/Contrast command 185
 - browser dithering 514
 - browser messages 505
 - brush cursor 333
 - Brush Stroke filters 391
 - brush tips
 - creating 336
 - shape options for 337
 - Brush tool
 - about 329
 - in vanishing point 228
 - brushes
 - airbrush option for 345
 - clearing options for 346
 - color dynamics of 343
 - dual 343
 - dynamic 339
 - preset 333
 - pressure sensitivity of 346
 - scattering 341
 - shape dynamics of 340
 - textured 342, 345
 - wet edge or watercolor 345
 - Brushes panel
 - about 335
 - keyboard shortcuts for 667
 - bump maps 403
 - Burn tool 205
 - Button Mode command 615
- C**
- Calculations command 277
 - Camera Raw
 - See also* camera raw files
 - about 80
 - database 99
 - DNG Profile Editor 92
 - preview controls 83
 - workflow options 102
 - XMP files 99
 - camera raw files
 - about 79
 - bit depth of 102
 - cache in Adobe Bridge 80, 83
 - chromatic aberration 92
 - copying and pasting settings in Adobe Bridge 100
 - correcting a color cast 92
 - database for settings 100
 - DNG Profile Editor 92
 - export settings 101
 - histogram and RGB values 87
 - local adjustments 96
 - non-neutral colors in 92
 - pixels in 102
 - postcrop vignette 93
 - preview controls 83
 - printing resolution for 102
 - reducing noise 95
 - resampling 102
 - saving and restoring settings 99
 - saving to other file formats 86
 - setting color profile and bit depth 102
 - sharpening 95
 - sidecar XMP files 100
 - tonal adjustment controls for 90
 - view controls 83
 - vignetting 93
 - white balance in 88
 - canceling operations 45
 - canvas
 - filling 355
 - resizing 192, 196
 - Canvas Size command 196
 - capitalizing text. *See* type, formatting
 - Cascading Style Sheets (CSS)
 - Generate CSS slice output option 525
 - CCITT compression 457
 - Chalk & Charcoal filter 394
 - Channel Mixer command
 - Constant option 181, 182
 - creating monochrome images 182
 - mixing channels 181
 - Output Channel option 181
 - channels
 - See also* alpha channels, Channels panel, color channels, spot channels
 - bit depth 55
 - blending 276
 - calculating 276
 - color 265
 - color information 55
 - deleting 269
 - duplicating 267
 - file size of 265
 - hiding and showing 266
 - inverting 181
 - layer mask 323
 - maximum number of 265
 - merging 268
 - mixing 181
 - options for 273
 - Quick Mask 271
 - saving selections in 274
 - selecting 266
 - sequence of 274
 - source 181
 - splitting into separate images 268
 - thumbnails 266
 - viewing 266
 - viewing in Histogram panel 151
 - Channels panel
 - about 266
 - changing display of 266
 - rearranging channels in 267
 - selecting channels in 267
 - Character panel
 - about 412
 - type size 413

- characters
 - scaling 422
- characters. *See* type
- Charcoal filter 394
- Check Spelling command 409
- chroma, about 105
- Chrome filter 394
- Cineon format
 - about 460
 - saving in 456
- circles, drawing 356
- CJK type. *See* Asian type
- Clear command 265
- Clear Layer Style command 306
- Clear mode 347
- Clear Slices command 504
- clipboard
 - clearing 51
 - copying between applications 263
 - Export Clipboard option 264
 - rasterizing images from 264
 - saving after quitting Photoshop 264
- clipping
 - about 161
 - groups 293
 - in Auto Levels command 185
- clipping masks 326
- clipping paths
 - about 469
 - printing 470
- Clone Source panel 197
- Clone Stamp tool 197
 - setting sample sources for 198
 - using 197
- cloning and healing set sample source 197
- cloning video and animation frames 541
- Close Path command in InDesign 365, 366, 367
- closed paths
 - creating with Pen tool 366
- Clouds filter 393
- CMYK color mode
 - out-of-gamut colors 160
 - selecting colors in 118
 - tonal and color adjustments in 160
- CMYK color spaces
 - about 106
 - previewing 160
- CMYK images
 - channel display 266
 - out-of-gamut colors 160
- CMYK inks. *See* process color inks
- color adjustments. *See* tonal and color adjustments
- color balance
 - adjusting automatically 185
 - adjusting with Curves 166
 - generalized adjustments 188
 - Replace Color command 180
- Color Balance command 184
- Color blindness
 - soft proofing colors for 135
- Color Burn mode 347
- color casts
 - See also* color balance
 - correcting with eyedroppers 168
 - correcting with Levels 163
- Color Channels In Color option 267
- color channels. *See* channels
- color corrections. *See* tonal and color adjustments
- color depth. *See* bit depth
- Color Dodge mode 347
- color fill layers 308
- color gamuts 126
- Color Halftone filter 393
- color management
 - See also* color profiles, color settings
 - about 126, 127, 128
 - color settings reference 144
 - considerations for importing images 132
 - considerations for printing documents 137
 - considerations for process and spot colors 131
 - creating a viewing environment 128
 - for online graphics 133, 134
 - for PDFs 134, 138
 - in video layers 542
 - managing printing in Photoshop 478
 - printing a hard proof 479
 - printing color targets 480
 - printing options 477
 - saving documents 441
 - setting up 129
 - soft-proofing colors 134, 135, 137
 - synchronizing color settings 130
- Color mode option 348
- color model working space 142
- color models
 - about 104
 - HSB 105
 - Lab 107
- color modes
 - Bitmap 107
 - conditional mode change 109
 - converting Bitmap to Grayscale 111
 - converting images between 108
 - converting to Bitmap mode 109
 - converting to Indexed Color 111
 - Duotone 107
 - Grayscale 107
 - Indexed Color 111
 - Lab Color 107
 - Multichannel 108
 - number of channels 55
 - RGB 106
 - setting in new images 65
 - viewing in Histogram panel 151
- color palettes
 - See also* Color panel
 - Adaptive 112
 - customizing 113
 - Exact 111
 - for indexed-color conversions 111
 - Mac OS 111, 114
 - matte color 113
 - number of colors 112
 - Perceptual 112
 - Selective 112
 - specifying background color 113
 - specifying colors 112
 - specifying transparency 112
 - Uniform 112
 - web 112
 - Windows 112, 114
- Color panel
 - See also* color palettes
 - about 120
 - alerts 119
 - selecting web-safe colors with 118
- Color Picker
 - Apple Color Picker 120
- color picker
 - Windows Color Picker 120
- color profiles
 - about 139
 - assigning and removing 142

- assigning and removing from documents 142
- converting 143
- for desktop printers 138
- for imported images 132, 133
- for monitors 140, 141
- installing 141
- warning messages for 146
- Color Range command
 - about 253
 - Fuzziness option of 254
 - selection preview 255
- color range, specifying for composition 298
- Color Replacement tool 204
- color samplers
 - about 153
 - adjusting 154
- color separations
 - about 473
 - adjusting traps 486
 - printing 485
- color settings
 - See also* color management
 - color conversions 147
 - color management policies 146
 - customizing 144
 - for Adobe applications 130
 - presets for 144
 - rendering intents 147, 148
 - synchronizing with other applications 130
 - working spaces 144, 145
- color spaces 104
- Color Table command 113
- Color Table panel 517
- color tables
 - customizing 113
 - dithering 113
 - editing colors in 113
 - for assigning transparency to colors 113
 - for indexed-color conversions 111
 - matte color 113
 - predefined 114
 - saving and loading 114
 - sorting 518
 - specifying background color with 113
 - specifying colors with 112
 - specifying transparency with 112
- color traps 486
- color values, previewing 153
- color wheel 104
- Colored Pencil filter 389
- colors
 - See also* background color, color management
 - See also* color management, color model
 - converting to grayscale 109
 - deleting 520
 - for type 414
 - in digital graphics 104
 - inverting in images 189
 - layers or groups 291
 - locking in Color Table panel 519
 - mapping to transparency 519
 - matching 178
 - shifting to Web panel 519
- columns, for precise positioning 37
- Combine Slices command 502
- Commands panel 45
- commands, recording in actions 618
- commercial printing 481
- Community help 2
- Community search engine 2
- complementary colors. *See* color wheel
- composition methods 428
- compression
 - about 457
 - PDF 448
- Conditional Mode Change command 109
- Constant option 182
- Contact Sheet II command 636
- Conté Crayon filter 394, 397
- Content-Aware Scale 220
- context menus, using 17
- Contiguous option 204, 332
- continuous-tone images, printing. *See* printing
- contour libraries 303
- contours 303
- contrast
 - adjusting 174
 - adjusting automatically 186
- conversion settings, presets 445
- Convert To Layer command 313
- Convert To Paragraph Text command 407
- Convert To Point Text command 407
- Convert To Profile command 143
- Convert To Shapes command 432
- Convert To Smart Object command 311
- convolution 396
- cooling filters 184
- Copy Frames command 550
- Copy Layer Style command 305
- copying
 - between applications 263
 - PostScript artwork from clipboard 264
 - selections 262
 - styles 305
 - using drag and drop 263
 - while dragging 262
- copyright information, adding 465
- correct lens distortion 206
- correcting mistakes 45
- Count tool 607
- Craquelure filter 396
- Create Droplet command
 - in Automate submenu 624
- Create Layers command 306
- Create Plane tool, in vanishing point 228
- Create Slice From Guides command 498
- Create UV Overlays command 584
- Create Work Path command (for type) 432
- Crop And Straighten Photos command 195
- Crop command 193
- Crop tool 32, 192, 194
- Crosshatch filter 391
- Crystallize filter 393
- CSS layers, generating 511
- curly quotes 408
- Current Path command 324
- curves
 - drawing, with Pen tool 365, 367
 - reshaping 374
- Curves command
 - about 163
 - adding points with 166
 - adjusting color and tone with 167
 - adjusting color balance and tonal range with 166
 - Auto options for 187
 - setting highlight and shadow values with 175
 - setting target values with 176
 - shortcuts for 167
 - using eyedropper tools to adjust tonality 168
- curves, creating smooth and sharp 372
- custom color filter, in Photo Filter command 184
- Custom filter 396

- custom ink colors, choosing in Adobe Color Picker 119
- Custom Spot Function option 484
- customizing shortcuts 648
- Cut command 265
- Cutout filter 389
- D**
- Dark Strokes filter 391
- Darken mode 347
- data sets
 - applying 630
 - defining 629
 - importing from external files 630
 - using batches of 630
- data-driven graphics
 - about 627, 629
 - applying data sets 630
 - generating graphics 630
 - variables 628
- DCS file format
 - about 268, 458
 - DCS 1.0 455
 - DCS 2.0 455
 - for images with spot channels 486
- default workspace
 - restoring 12
- Define Brush command 336
- Define Pattern command 357
- defining and adjusting perspective planes
 - with vanishing point 228
- defining shortcuts 648
- Defringe command 260
- De-Interlace filter 396
- Delete Color command 520
- Delete Workspace command 13
- deleting
 - alpha channels 269
 - channels 269
 - colors from swatch sets 122
 - locked selections 265
 - objects 265
 - selections 265
 - slices 503
- Desaturate command 189
- Deselect All Colors command 518
- Deselect command 248
- deselecting selections 248
 - See also* selecting
- desktop printers, color profiles for 138
- Despeckle filter 392
- detection width, Magnetic Lasso tool 250
- Device Central integration
 - Photoshop 443
- Diameter option 337, 343
- Diamond Gradient tool 350
- DIC Color Guide 119
- DICOM file format, about 460
- DICOM files
 - about 597
 - exporting as JPEG 600
 - opening 598
 - viewing metadata 600
- Difference Clouds filter 393
- Difference mode 348
- Diffuse filter 395
- Diffuse Glow filter 391
- diffusion dither 516
- Digimarc filters
 - about 465
 - before adding 466, 467
 - reading a watermark 465
 - signal strength meter for 468
 - Watermark Durability setting of 467
- Digital Negative file format, about 459
- Direct Selection tool
 - activating temporarily 374
- direction lines and points
 - moving 374
- Directional lighting effect 401
- Disable Auto Add/Delete command 379
- Displace filter 391
- displacement maps 391
- Display & Cursors preference 266
- Dissolve mode 347
- distort an image 214
- Distort filters 391
- distortions
 - applied with Liquify filter 223
 - reconstructing 226
- Distribute Layers command 287
- distributing
 - layers 287
 - shapes 378
- dithering
 - about 113
 - browser 514
 - in animations 563
 - No Dither setting 521
 - shifting to web-safe colors 519
 - transparency, in Optimize panel 516
- Divide Slices 501
- DNG (Digital Negative) 459
- document dimension, viewing 35
- document profiles. *See* color profiles
- document size
 - about 61
 - viewing 35
- document window, viewing file information
 - in 34
- documents, keyboard shortcuts for 659
- Dodge tool 205
- double-byte type. *See* Asian type
- downloads
 - updates, plug-ins, and tryouts 3
- downsampling
 - about 59
 - in PDF files 448
- dpi (dots per inch) 55
- drawing
 - about 359
 - circle or square 356
 - curves followed by straight lines 367
 - custom shape 362
 - doughnut or wheel shape 361
 - from center out 360
 - multiple shapes on a layer 361
 - paths, with Pen tool 364, 365, 367
 - shapes 360
- drawing modes 359
- Drop Shadow effect 300
- droplets
 - about 624
 - compatibility issues 624
 - creating for various operating systems 624
 - creating in Photoshop 624
 - processing files with 624
- Dry Brush filter 389
- dual brushes 343
- Duotone mode 107
- duotones
 - about 488
 - creating 488
 - curves 489
 - exporting to other applications 490
 - overprint colors 489
 - printing 490

- saving and loading settings 490
 - viewing individual plates 490
- Duplicate Channel command 267
- Duplicate command 35
- Duplicate Merged Layers Only option 35
- Duplicate Path command 377
- Dust & Scratches filter 392
- Dynamic Color Sliders option 121
- Dynamic Shortcuts 413
- E**
- edge effects 388
- edge sensitivity, Lasso tool 251
- edges, smoothing 380
- Edit Plane tool, in vanishing point 228
- effects
 - grouping blend 296
 - modifying with contours 303
 - removing 306
 - scaling 306
 - scaling effects 306
- Elliptical Marquee tool 248
- e-mail
 - saving to 512
- Embed Color Profile option 441
- Embed Watermark command 467
- Emboss filter 395
- empty cells 525
- Encapsulated PostScript (EPS). *See* EPS files
- endpoints
 - connecting 375
- EPS file format
 - binary encoding 455
 - JPEG encoding 455
 - saving files in 454
- EPS files
 - about 458
 - binary encoding 455
 - JPEG encoding 455
 - opening 68
 - saving 454
 - saving for page layout 468
 - saving in DCS format 455
- Equalize command 189
- Erase To History mode 332
- Eraser tool 45, 331
- erasing
 - about 331
 - backgrounds 332
 - fastening points in a selection 249
 - lasso segments 250
 - to history to restore previous state 45
- Events Manager 627
- Every-line Composer 428
- Exchange 3
- Exclusion mode 348
- Export Contents command 312
- Export Layers To Files command, in Photoshop 456
- exporting
 - 3D information in vanishing point 228
 - duotones 490
 - measurement in vanishing point 228
 - paths 471
 - textures in vanishing point 228
 - transparency 469
- Extensible Metadata Platform (XMP) 464
- Extract command, previewing with 645
- Extract filter 643, 644
- extracting objects from background 644
- Extras 3
 - See also names of individual Extras*
 - showing and hiding 40
 - target path 376
- Extrude filter 395
- eyedropper sample 115
- Eyedropper tool
 - about 154
 - Black Point 168
 - Gray Point 163
 - in Hue/Saturation command 170
 - in vanishing point 228
 - target color for 168
 - White Point 168
- F**
- Facet filter 393
- fastening point 251
- feathering 259
- file compression. *See* compression
- file formats
 - See also* compression, Save For Web dialog box, *individual format names*
 - about 440, 457
 - animation and movie 460
 - for nonsupported previews 459
 - supporting paths 371
- file size
 - about 58
 - required for alpha channels 265
- fills, keyboard shortcuts for 661
- Filmstrip format 460
- Filter Gallery 385
- filter masks 315
- filters
 - applying 385, 386
 - applying cumulatively 385
 - applying from Filter Gallery 385
 - Artistic 389
 - Blur 389
 - Brush Stroke 391
 - Colored Pencil 389
 - creating backgrounds with 388
 - creating special effects with 388
 - Cutout 389
 - Digimarc 397, 465
 - Distort 391, 398
 - Dry Brush 389
 - Fine Grain 389
 - for 16-bit images 384
 - for 8-bit images 384
 - Fresco 389
 - improving performance with 388
 - Lens Blur 213, 390
 - Lighting Effects 400
 - scanning and 487
 - tracking 292
- filename extensions, preferences for saving 442
- files
 - extensions for 441
 - saving preferences 442
- Fill command 355, 356
- fill layers
 - about 307
 - creating 308
 - editing 309
 - merging 309
- fill opacity 294
- fill pixels 360
- Fill tool 645
- Fill With Neutral Color option 295
- filling
 - layers 354
 - paths 381
 - selections 354
 - type 414
 - with foreground or background color 355
 - with gradients 350
 - with history state 45

- Neon Glow 389
- Noise 392
- Other 396
- Paint Daubs 389
- Pixelate 393
- previewing 385, 386
- Render 393
- Repeat Edge Pixels option 398
- Sharpen 394
- Sketch 394
- Stylize 395
- Video 396
- Wrap Around option 398
- Find And Replace command 410
- Find Edges filter 395
- Fine Grain filter 389
- Finger Painting option 204
- Fit On Screen command 30
- Flatten Frames Into Layers command 564
- Flatten Image command 293
- flattening
 - images 293
- flattening, images 293
- flipping images
 - precisely 217
- flipping, images 195
- floating boxes. *See* CSS layers
- FOCOLTONE color system 119
- font installation 2
- fonts
 - font families 415
 - missing 417
 - OpenType 418
 - previewing 416
- foreground color
 - choosing 114, 121
 - editing with Color panel 121
 - filling selections with 355
 - selecting with Eyedropper tool 115
- formats
 - for image sequences 528
 - for video 528
- fractional character widths 422
- Fragment filter 393
- frame delay 552
- frames
 - adding 548
 - selecting 549
 - tweened 551
- framing images 197
- Free Transform command, about 217
- Freeform Pen tool 368
- freeze areas, with Liquify filter 222
- frequency. *See* screen frequency 59
- Fresco filter 389
- fringe pixels, removing 260
- function keys 672
- G**
- Gamma command 508
- gamuts 126, 160
- Gaussian Blur filter 390
- General preferences
 - Disable Auto Add/Delete 378, 379
- GIF file format
 - about 460
 - Interlaced option for 454
 - Normal option for 454
 - optimization options for 513
 - web optimization settings 513
- Glass filter 391, 397
- global lighting 303
- Glowing Edges filter 395
- glyph protection 417
- glyphs
 - in OpenType fonts 418
- glyphs, spacing of 425
- Gradient Editor dialog box 352
- Gradient Fill tool 32
- Gradient Map command 190
- Gradient tool 32
- gradient tools. *See individual gradient tool names*
- gradients
 - applying 350
 - creating 352
 - creating presets for 353
 - fill layers 308
 - keyboard shortcuts for 661
 - library 351
 - mapping tonal range to 190
 - transparency 351, 352
- Grain filter 396
- Graphic Pen filter 394
- grayscale images
 - about 107
 - colorizing 91, 170
 - converting from Bitmap mode 111
 - converting to black-and-white images 190
 - converting to indexed color 111
 - creating by mixing channels 181
 - creating from color images 109, 189
 - halftone screen attributes for 484
 - storing selections in 265
- grids 38
- groups
 - adding layers to 285
 - blending modes 294
 - grouping layers 285
 - viewing 283
- Grow command 258
- guides
 - Smart Guides 38
 - snapping 38
- H**
- halftone cell 59
- Halftone Pattern filter 394
- halftone screens
 - about 59
- halftones
 - about 484
 - Custom Spot Function option 484
 - saving settings of 485
 - selecting attributes for 483
- Hand tool 27
- handtinted images 182
- hanging punctuation 426, 427
- Hard light mode 347
- Hard mix mode 348
- hard proof 479
- Hardness option 338
- HDR Color Picker
 - choosing colors with 76
 - displaying 76
- HDR images
 - about 71
 - converting to 8 or 16 bits per channel 75
 - Merge To HDR command 73, 74
 - painting on 78
 - viewing 75
- healing brush tool 197
- hexadecimal color values 118
- Hide All Layer Styles command 304
- Hide Auto Slice command 500
- Hide Slice Number command 500
- hiding and showing
 - alert messages 44
 - channels 266

- grid and guides 38
- layer styles 304
- tool tips 13
- using layer masks 320
- High Dynamic Range images. *See* HDR images 71
- High Pass filter 396
- High Quality Print, PDF preset 446
- high-key images 149
- highlights
 - adjusting with Levels 162
- Histogram panel
 - about 149
 - adjusting histogram view 150
 - All Channels View 150
 - Compact View 150
 - displaying channels in color 151
 - Expanded View 150
 - previewing adjustments in 152
 - refreshing 152
 - showing 149
 - statistics 151
 - viewing a specific channel in 151
- histograms
 - about 149
 - cache level 152
 - reading 149
- History Brush tool 45, 50
- History panel
 - about 46
 - and batch processing 623
- history states
 - deleting 47
 - options 48
 - painting with snapshot 50
 - replacing 331
 - reverting to previous 47
- HKS color model 120
- HSB color model 105
- HTML
 - adding HTML text to slices 505
 - ALT element 505
 - cell alignment for text 506
 - MESSAGE element 505
 - output settings 524, 525
 - target frame 505
 - URLs in slices 505
- Hue mode 348
- hue, about 105
- Hue/Saturation command
 - about 168
 - adjusting 168
 - colorizing grayscale images with 170
 - modifying color range with eyedroppers 170
 - specifying range of colors with 169
- hyphenation
 - automatic 427
 - composition methods and 428
 - options 427
 - preventing breaks 428
- I**
- ICC Profile option 441
- ICC profiles
 - See also* color profiles
 - embedding in files 513
- icons
 - panels as 11
- IFF format, about 460
- Illustrator. *See* Adobe Illustrator
- image areas
 - adjust color saturation 197
 - blur 197
 - dodge or burn 197
 - replace color 197
 - sharpen 197
 - smudge 197
- image noise
 - about 208
 - defined 95
 - reducing 206
- Image Previews option 442
- Image Processor 622
- image resolution 55
- image size 56
- Image Size command
 - changing pixel dimensions 61
 - using Auto option 62
- image stacks
 - about 611
 - converting to a layer 611
 - creating 611, 613
 - editing 611
 - stack modes 612
- images
 - applying perspective 214
 - bit depth 55
 - color adjustments 155
 - combining multiple 327
 - converting between bit depths 56
 - converting between color modes 108
 - copying selections between 262
 - creating 64
 - creating from history state 47
 - creating from snapshot 47
 - creating monochrome with 182
 - creating panoramic 243
 - cropping 192
 - displaying size of 58
 - distorting with Liquify filter 222
 - flattening 293
 - flipping or rotating precisely 214
 - grayscale 107
 - handtinted 182
 - high-key and low-key 149
 - indexed-color conversion options 111
 - loading selections into 275
 - magnifying 28
 - maximum size of 58
 - posterizing 190
 - preserving highlight and shadow detail in 175
 - previewing for use in video 561
 - print dimensions of 61
 - printing 473
 - pseudocolor 113
 - reconstructing with Liquify filter 226
 - resampling 59
 - restoring 45
 - resizing in Save For Web dialog box 511
 - reverting to any state 46, 50
 - RGB 106
 - rotating or flipping 192, 195
 - saving 440
 - scanning 63, 64
 - sharpening 209, 210, 211
 - skewing 214, 218
 - trimming 193
- Import command 647
- Import Folder As Frames command 537
- importing
 - See also* scanning
 - artwork by dragging 263
 - Illustrator art 65
 - images with WIA support 63, 64
 - indenting paragraphs 426
- InDesign. *See* Adobe InDesign

- Indexed Color mode
 - about 111
 - conversion options 111
 - converting RGB and Grayscale images to 111
 - using type with 404
- Info panel
 - about 32
 - before-and-after color values in 32
 - color corrections display 32
 - options for 33
 - out-of-gamut colors 32
 - previewing color changes in 153
 - showing 153
 - using 33
- information box 58
- Ink Outlines filter 391
- Inner Glow effect 300
- Inner Shadow effect 300
- input device profiles 139, 141
- Insert Stop command 619
- interactivity
 - creating with CSS layers 511
- International Color Consortium (ICC) 128
- International Press Telecommunications Council. *See* IPTC
- interpolation methods 60
- Intersect With Channel option 274
- Inverse command 256
- Invert command 189
- IPTC 100
- ISO standards 447
- ITPC 100
- J**
- JavaScript 626, 627
- jitter
 - about 339
 - angle 340
 - color 344
 - count 341
 - flow 345
 - opacity 345
 - roundness 341
 - size 340
 - texture depth 342
- JPEG artifacts 206, 209
- JPEG compression. *See* JPEG format
- JPEG encoding, in EPS files 455
- JPEG files
 - optimization options 513
- JPEG format
 - about 461
 - compression 457
 - saving files in 453
 - specifying image quality 453
- justifying type 425
 - See* type, formatting
- K**
- kerning 420, 421
- keyboard shortcuts
 - full list of 648
- keystone distortion, correcting 194
- kinsoku shori. *See* Asian type
- knockouts
 - and spot colors 493
 - creating 295
- Kotoeri Character panel 436
- L**
- Lab Color mode
 - about 107
 - in Adobe Color Picker 118
- Lab color model 107
- Lab images
 - blending modes for 295
 - channel display in 266
- languages, assigning to text 410
- Large Document Format (PSB)
 - about 461
 - saving in 442
- Lasso tool
 - stylus pressure options for 251
 - using 249
- Lasso Width option 250
- layer comps
 - applying and viewing 318
 - deleting 318
 - updating 318
 - validating 318
 - working with 317
- Layer Comps panel 317
- layer edges 286
- layer mask channel 323
- Layer Mask Hides Effects option 297
- layer masks
 - adjustment layers as 308
 - disabling and enabling 323
 - discarding 325
 - displaying 323
 - displaying channel 323
 - editing 321
 - loading as selections 325
- layer styles
 - contours 303
 - custom 300
 - editing 306
 - expanding and collapsing 304
 - hiding and showing 304
 - options for 301
 - presets 304
 - removing 306
 - scaling effects in 306
 - type layers 404
- Layer Via Copy command 312
- Layer Via Cut command 282
- layer-based slices, creating 499
- layers
 - See also* type layers
 - adjustment layers, about 307
 - aligning 287, 327
 - applying preset styles to 299
 - background 281
 - blending automatically 289
 - blending range and 298
 - changing stacking order of 285
 - clipping masks and 326
 - color-coding 291
 - converting styles to 306
 - converting to CSS layers 511
 - copying and pasting styles in 305
 - creating 281
 - creating new document from 283
 - creating slices from 498
 - creating vector masks with 320
 - deleting 292
 - distributing 287
 - duplicating 282
 - editing vector masks in 320
 - exporting 292
 - exporting to files 456
 - filling 354
 - filling with neutral color 295
 - flattening 293
 - flattening from animation frames 564
 - grouping 285
 - hiding and showing 283
 - in channel calculations 276, 277

- knockout 295
 - linking 285
 - loading boundaries as selection 325
 - locking 290
 - mask 319
 - merging 292
 - modifying effects in 303
 - moving 285, 286
 - opacity 294
 - painting transparency 347
 - rasterizing 291
 - removing effects 306
 - renaming 291
 - rotating 290
 - sampling 283
 - saving 441
 - scaling effects in 306
 - selecting 284
 - selecting opaque areas of 325
 - showing edges 286
 - stroking 354
 - thumbnails 280
 - unifying 550
 - unlinking masks in 325
 - viewing 283
 - Layers panel
 - about 280
 - keyboard shortcuts for 669
 - leading in Asian type 434
 - Lemple-Zif-Welch (LZW) compression 457
 - Lens Blur filter 213, 390
 - lens blur, adding 209
 - Lens Correction filter 207
 - lens distortion 206
 - Lens Flare filter 393
 - letter spacing 420, 425
 - letterbox scaling 562
 - letters. *See* type
 - Levels command
 - about 161
 - adjusting tonal range with 161, 162
 - adjusting tonality with eyedroppers in 168
 - assigning highlight and shadow values with 175
 - Auto options for 187
 - correcting color casts with 163
 - Input Levels sliders 161
 - Output Levels sliders 175
 - Set Gray Point eyedropper in 163
 - setting target values with 176
 - Lighten mode 347
 - Lighter color mode 348
 - lighting effects 303
 - Lighting Effects filter
 - about 393, 400
 - adding 402
 - creating styles with 402
 - textures in 403
 - Lighting Effects filter styles 402
 - Lighting Effects types 401
 - Line tool, measuring distances with 32
 - Linear Burn mode 347
 - Linear Dodge mode 347
 - Linear Gradient tool 350
 - Linear Light mode 348
 - lines
 - adjusting angle and length 374
 - drawing 329
 - drawing, with Pen tool 364, 365, 367
 - moving 374
 - reshaping 374
 - linked files
 - color management considerations 132
 - Liquify filter
 - about 222
 - applying meshes with 227
 - distorting images with 222, 223
 - freezing and thawing areas with 225
 - inverting frozen areas with 225
 - moving pixels right with 223
 - reconstructing 226
 - saving meshes with 227
 - setting tool options for 224
 - showing backdrops with 228
 - using mask options of 225
 - Liquify filter tools 223, 224, 226
 - Load Actions command 617
 - loading
 - color tables 114, 520
 - contours 303
 - duotone curves 489
 - output settings 524
 - pattern libraries 356
 - tonal and color adjustment settings 159
 - Lock Slice command 504
 - Lock/Unlock Selected Colors command 520
 - locking layers 290
 - locking slices 504
 - looping, in animations 553
 - lossless compression formats 457
 - lossy compression
 - JPEG format and 457
 - low-key images 149
 - lpi (lines per inch) 55, 59
 - Luminosity mode 348
 - luminosity, viewing in Histogram panel 151
- ## M
- Mac OS system color panel 111, 114
 - Magic Eraser tool 331
 - Magic Wand tool 253
 - Magnetic Lasso tool 250
 - Magnetic Pen tool 369
 - magnifying images 29
 - Make Selection command 380
 - Make Work Path command 381
 - mapping colors to transparency 519
 - marquee tools
 - about 248
 - coordinates in Info panel 32
 - Fixed Size option 248
 - in vanishing point 228
 - mask editing colors 273
 - mask options, with Liquify filter 222
 - Masked Areas option 272
 - masks
 - about 269
 - adding filter masks 316
 - adding to layers 320, 324
 - applying to Smart Filters 315
 - changing opacity of 273
 - channels saved as 274
 - choosing color of 273
 - clipping 326
 - creating from a selection 274
 - creating in alpha channels 273
 - creating temporary 271
 - deleting filter masks 316
 - disabling filter masks 316
 - for type 432
 - layers 319
 - removing quick masks 272
 - saving as alpha channels 269
 - saving selections in 269
 - selecting opaque areas with 325
 - unlinking from layers 325
 - vector 320

- Match Color command
 - about 177
 - adjusting color with 179
 - matching color between layers 178
 - matching colors 178
 - MATLAB
 - command reference 610
 - connecting to 609
 - creating a Photoshop document in 610
 - setup 609
 - using with Photoshop 609
 - matte color, choosing 113
 - Matting command 260
 - Matting commands 260
 - Maximum filter 213
 - measurement
 - data points 603
 - exporting measured data to a file 606
 - tools 603
 - types of 603
 - Measurement Log panel 606
 - measurement scale
 - creating presets 601
 - setting 601
 - measuring
 - about 37
 - angle of rotation 32
 - changing units used for 36
 - in vanishing point 228
 - using a selection area 603
 - using cropping marquee 32
 - using Line tool 32
 - Median filter 213, 392
 - median pixel values 151
 - memory, freeing 51
 - menus
 - customizing 17
 - deleting a set of 18
 - turning colors on or off 18
 - viewing hidden items in 18
 - Merge Channels command 268
 - Merge Spot Channel option 493
 - Merge To HDR command 73
 - Merge Visible Layers command 293
 - merging
 - adjustment or fill layers 309
 - all visible layers 293
 - channels 268
 - layers 292
 - stamped layers 293
 - meshes, saving with Liquify filter 227
 - MESSAGE HTML element 505
 - metadata
 - about 464
 - Mezzotint filter 393
 - midtone, adjusting with Levels 162
 - Minimum and Maximum filter 396
 - modal controls, in actions 620
 - modes. *See* blending modes, color modes
 - moiré patterns in printing 483
 - mojikumi. *See* Asian type
 - monitor profiles 139, 140, 141
 - monitor resolution
 - scaling and 58
 - monochrome, converting to 190
 - monotone. *See* duotone
 - Mosaic filter 393
 - Mosaic Tiles filter 396
 - Motion Blur filter 390
 - Move tool 261
 - moving
 - keyboard shortcuts for 660
 - layers 286
 - paths 376
 - slices 500
 - Multichannel mode
 - about 108
 - and deleted channels 269
 - using type 404
 - multiple copies. *See* duplicating
 - Multiple Master fonts 416
 - Multiply mode 347
- N**
- Navigator panel 28
 - negatives
 - creating 189
 - Neon Glow filter 389
 - New Action command 618
 - New Color command 518
 - New command 64
 - New layer-based Slice command 499
 - New Smart Object Via Copy command 312
 - New Snapshot button 49
 - New View command 31
 - No Break command 428
 - noise
 - in brushes 345
 - in camera raw images 95
 - noise gradients 354
 - Noise filters 392
 - noise, dither 516
 - Nondestructive editing, about 309
 - nonprintable colors 119
 - Normal mode 347
 - Note Paper filter 394
 - NTSC Colors filter 396
 - nudging anchor points and path segments 376
- O**
- Ocean Ripple filter 391
 - Offset filter 397
 - OLE (Object Linking and Embedding) 471
 - Omni lighting effect 401
 - online resources 3
 - opacity
 - fill 294
 - gradients 353
 - layer mask 323
 - of background layer 294
 - Open As command 66
 - Open As Smart Object command 311
 - Open command 66
 - open passwords, in PDFs 450
 - open paths
 - creating, with Pen tool 367
 - Open Recent command 66
 - OpenEXR format 461
 - OpenGL Drawing, enabling 572
 - opening
 - EPS files 68
 - PDF files 66
 - OpenType fonts
 - about 418
 - previewing 416
 - Optimize By Bounding Box option 563
 - Optimize By Redundant Pixel Removal option 563
 - Optimize panel
 - specifying transparency dithering in 516
 - optimizing
 - See also* optimizing web graphics
 - about 506
 - GIF and PNG-8 files 513
 - JPEG files 512
 - SWF (Flash) files 521
 - optimizing web graphics
 - basic procedure for 508
 - compressing to specific file size 510

- file formats for 512
 - generating CSS layers 511
 - previewing results 512
 - saving presets 509
 - SVG options 523
 - using Color Table panel for slices 517
 - options bar, moving 25
 - Other filters 396
 - Outer Glow effect 300
 - out-of-gamut colors
 - about 160
 - alert in Color Picker 116
 - selecting 254
 - shown in Info panel 32
 - output device profiles 138, 139, 141
 - Output Settings dialog box
 - HTML output options in 524
 - setting options in 524
 - Overlay mode 347
 - overprint colors 489
 - Oversized Pages, PDF preset 446
- P**
- page marks 482
 - page setup 473, 476
 - Paint Bucket tool 354
 - Paint Daubs filter 389
 - painting
 - options 346
 - tools for 328
 - with a color in vanishing point 228
 - with patterns 330
 - with sampled pixels in vanishing point 228
 - Palette Knife filter 389
 - palettes
 - See also* panels
 - panel menu, displaying 8
 - panels
 - See also* palettes
 - about 6
 - collapsing to icons 11
 - docking 9
 - grouping 11
 - keyboard shortcuts for 664
 - moving 10
 - showing and hiding 8
 - stacking 11
 - panoramas
 - 360 degree 245
 - panoramic images, creating 243
 - Paragraph panel, about 423
 - paragraph type. *See* type
 - paragraphs
 - about 423
 - formatting 423
 - hanging punctuation 426, 427
 - hyphenation 427, 428
 - indenting 426
 - spacing between 426
 - word and letter spacing 425
 - Pass Through blending mode 294
 - passwords, in PDFs 450
 - Paste Into command 261
 - pasting
 - frames 550
 - PostScript artwork 264
 - selections 262
 - patch area 197
 - Patch tool 202
 - Patchwork filter 396
 - path components 372
 - copying 377
 - deleting 378
 - moving 376
 - overlapping 377
 - reshaping 377
 - path segments
 - nudging 376
 - paths
 - about 372
 - adjusting 376
 - adjusting angle and length 374
 - clipping 469
 - closed 372
 - closing 365, 366, 367
 - combining 375
 - connecting 375
 - copying 377
 - created from type 432
 - creating new 370
 - curved segments 367
 - defining transparency 469
 - deleting 371, 375
 - distributing 378
 - drawing freehand 368
 - drawing, with Pen tool 364, 365, 367
 - editing 376
 - exporting to Illustrator 471
 - filling 381, 382
 - from selection borders 381
 - leaving open 367
 - managing 371
 - moving 374
 - open 372
 - overlapping 376
 - printing 470
 - renaming 371
 - repositioning 376
 - reshaping 374
 - saving 371
 - selecting 370, 373
 - straight segments 367
 - stroking 383
 - text on 429
 - Paths panel 370
 - Paths To Illustrator command 471
 - Pattern buffer 51
 - pattern dither 516
 - Pattern Maker 645
 - Pattern Stamp tool 330
 - patterns
 - about 357
 - defining image as 357
 - fill layers 308
 - filling selections with 355
 - generating with Pattern Maker 646
 - load library of 358
 - painting with 330
 - PostScript Pattern folder 357
 - saving library of 358
 - PCX file format 461
 - PDF conversion settings 445
 - PDF files
 - compatibility levels 447
 - security 450
 - PDF presets
 - about 445
 - creating 445
 - PDF version capabilities 447
 - PDF/X-compliant files
 - color management considerations 138
 - standards 447
 - PDF/X-compliant files, options 450
 - PDFs
 - Adobe PDF presets 450
 - color management considerations 134, 138
 - compliance with PDF/X standard 447
 - compression 448

- downsampling 448
- opening 66
- Photoshop PDF 462
- saving 444
- Pen tool
 - drawing curves 365, 368
 - drawing curves and lines 367
 - drawing straight lines 364
 - override automatic switching 379
 - overriding switching 378
- pen tools 32
 - about 364
- Pencil tool
 - about 329
 - auto erasing with 333
- Perceptual color palette
 - about 112
 - number of colors 112
- permissions passwords
 - in PDFs 450
- perspective
 - adjusting 206
 - applying 218
 - changing by cropping 194
 - correcting 207
 - transforming 194
- perspective planes
 - working with vanishing point 228
- Photo Filter command
 - about 183
 - cooling filters 184
 - custom color filters 184
 - warming filters 184
- photo frames 192
- photo galleries
 - creating 637
 - styles 640
 - using tokens in 640, 641
- Photocopy filter 394
- Photomerge
 - about 243
 - creating a composition 243
 - creating a photomerge interactively 243
 - selecting files to use in 244
 - source photographs for 243
 - taking pictures for 243
 - using from Bridge 244
- Photoshop 2.0 format, opening files in 458
- Photoshop EPS format. *See* EPS files
- Photoshop format 458
- Photoshop PDF format 462
- Photoshop Raw format
 - about 459
 - saving in 455
- Photoshop. *See* Adobe Photoshop
- PICT files
 - about 462
 - PICT Resource format 462
- Picture Package command
 - about 633
 - customizing layouts 635
- pillarbox scaling 562
- Pinch filter 391
- pincushion distortion 206
- Pixar format 462
- Pixel Aspect Ratio Correction command 534
- pixel aspect ratios
 - assigning 536
 - customizing 536
 - deleting values 536
 - restoring default values 536
- pixel depth. *See* bit depth
- pixel dimensions
 - maximum 58
 - new channels 265
 - resampling and 59
 - viewing 58
- pixel values
 - mean 151
 - median 151
 - previewing 153
 - standard deviation 151
- Pixelate filters 393
- pixelation, causes of 55
- pixels
 - displaying color values of 32
 - histogram display of 151
 - per inch (ppi) 55
 - selecting 247
- pixels, about 54
- Plaster filter 395
- Plastic Wrap filter 389
- Playback Options command 615
- plug-ins
 - for importing scanned images 63
 - for unsupported file format 457
 - in Adobe Store 3
 - selecting folder for 44
- PNG file format
 - about 462
 - Interlaced option 453
 - options for 453
 - saving files in 453
- PNG-24 file format
 - optimization options 521
- PNG-8 file format
 - optimization options 513
- point size. *See* type, formatting
- point type. *See* type, formatting
- Pointillize filter 393
- points, fastening 251
- Polar Coordinates filter 392
- Polygonal Lasso tool 249
- pop-up panels
 - about 15
 - changing display of 16
 - customizing list of items in 16, 42, 335
- Portable Bit Map format 463
- Portable Document Format (PDF)
 - about 461
 - saving files in 444
- positives, creating 189
- Poster Edges filter 389
- Posterize command, about 190
- posterizing images 190
- PostScript Language Reference Manual 484
- PostScript, point size 37
- ppi (pixels per inch) 55
- preferences
 - Color Picker 120
 - Enable OpenGL Drawing 572
 - gamut warning color 160
 - plug-in module 44
 - Plug-Ins & Scratch Disks 51
 - recent file list 66
 - restoring to default settings 43
 - transparency display 283
- Preserve Transparency option 331
- preserving highlight and shadow detail 175
- presets
 - brush 333
 - contour 303
 - for converting files 445
 - gradient 353
 - PDF export 445
 - style 299
- Press Quality, PDF presets 446

- previewing
 - channel calculations 277
 - color and pixel values 153
 - colors. *See* soft-proofing
 - documents on a video monitor 561
 - extracted objects 645
 - layers 283
 - printed image 62
 - selection boundary 258
 - video and animation in the timeline 561
 - Print command 473, 474
 - print dimensions, changing 61, 476
 - Print One Copy command 474
 - Print Options command 473
 - printer driver color management 477
 - printer profile targets 480
 - printer resolution 58
 - printer's marks 482
 - printer's points 37
 - printing
 - about 473
 - color management considerations 137
 - color separations 485
 - color trapping before 486
 - commercial 481, 482
 - continuous-tone images 473
 - duotones 490
 - halftone attributes for 483
 - images 473
 - options, setting 474
 - overprint colors 489
 - page setup for 476
 - part of an image 477
 - previewing 62, 474
 - scaling for 477
 - vector graphics 477
 - with color management 477
 - printing inks, density of 493
 - process colors
 - about 491
 - color management considerations 131
 - simulating solidity 492
 - Proof Color command 160
 - Proof Setup command 135, 160
 - Protect Foreground Color option 332
 - proxy view area 28
 - PSD format 458
 - Pucker tool 223
 - punctuation, hanging. *See* type, formatting
 - Purge command 51
- Q**
- quadtones. *See* duotones
 - Quick Mask mode
 - changing opacity with 273
 - options 272
 - turning off 272
 - Quick Selection tool 252
 - quotation marks, about 408
- R**
- Radial Blur filter 390
 - Radial Gradient tool 350
 - Radiance format 463
 - Randomize option 354
 - raster images. *See* bitmap images
 - rasterized type. *See* type
 - rasterizing
 - Illustrator artwork 264
 - layers 291
 - PostScript artwork 68
 - type layers 411
 - read me file 2
 - Reconstruct tool 226
 - modes 227
 - recording, actions 618
 - recording, inserting stops in 619
 - Rectangular Marquee tool 248
 - Red Eye tool 203
 - red eye, removing 197
 - reference point 216
 - Refine Edge command 258
 - Reflected Gradient tool 350
 - registration of software 1
 - Remove Black Matte command 260
 - Remove White Matte command 260
 - Render filters 393
 - rendering grids. *See* grids
 - rendering intents 148
 - renmoji. *See* Asian type
 - Reparameterize command 584
 - Replace Actions command 617
 - Replace Channel option 274
 - Replace Color command 180
 - Replace Contents command 312
 - resampling
 - See also* resizing
 - about 59
 - interpolation methods 60
 - Reselect command 248
 - Reset Actions command 617
- resizing
- about 59
 - images during printing 476
 - slices 500
 - type 406
- resolution
- about 56
 - determining optimal 62
 - displaying 58
 - document size and 61
 - file size and 58
 - of bitmap images 55
 - of printer 55
 - screen frequency and 59
- Restore To Background option 553
 - restoring images. *See* images
 - result color of blend 346
 - Reticulation filter 395
 - retouching
 - Clone Stamp tool 197
 - with Healing Brush tool 197
 - with Spot Healing Brush tool 197
 - Revert command 45
 - RGB Color mode 106
 - selecting color in 117
 - tonal and color adjustments in 160
 - RGB color space, Adobe 145
 - RGB images
 - channel display 266
 - converting to indexed color 111
 - specifying colors numerically in 121
 - Rich Content PDF setting 446
 - Ripple filter 392
 - rollovers, tools for creating 495
 - Rotate Canvas command 195
 - rotating
 - images 195, 214, 218
 - layers and selections 218
 - precisely 217
 - Rough Pastels filter 389, 397
 - Roundness option 338
 - Ruler tool 37
 - rulers
 - about 36
 - changing settings 36
 - zero origin 36
 - Run Length Encoding (RLE)
 - compression 457

S

- Sampled Blur filter 390
- sampling
 - from layers 283
 - images with a tool 197, 200, 202
- saturation
 - about 105
 - adjusting 168, 206
 - adjusting a specific color range 91
- Saturation mode 348
- saturation, adjusting 206
- Save A Version command 440
- Save Actions command 617
- Save As command 440, 441
- Save command 440, 441
- Save Current command 13
- Save For Web command 440, 506
- Save For Web dialog box
 - about 507
 - Color Table panel in 517
 - Image Size panel in 511
 - resizing images in 511
 - viewing annotations in 508
 - working with slices in 510
- Save Optimized command 506
- Save Selection command 274
- Save Workspace command 13
- saving
 - See also individual file format names*
 - alpha channels 441
 - as a copy 441
 - color tables 114, 520
 - color-managed documents 441
 - copyright information 465
 - duotone curves 489
 - duotone settings 490
 - embedded watermarks 465
 - for use in Illustrator 469
 - image previews 442
 - images 440
 - layers 441
 - options 441
 - page layouts 468
 - preferences 441
 - specifying file extensions when 442
 - spot channels 441
 - thumbnails 441
 - to Illustrator 469
 - tonal and color adjustment settings 159
 - with lowercase file extensions 441
- Scale Effects command 306
- scale markers
 - creating 602
 - deleting 602
- scaling
 - content-aware 220
 - images 214
 - images during printing 476
 - layer styles 306
 - type 422
- scanning 64
 - about 63
 - at correct resolution 60
 - predicting file size for 487
- Scitex format 463
- scratch disks 50
- scratch size, viewing 35
- screen frequency
 - about 55, 59
 - determining resolution 62
 - saving settings for 485
 - scanning and 487
 - setting 483
- Screen mode 347
- screen ruling 483
- Script Events Manager 627
- scripting
 - See also actions, automating, droplets*
 - for Photoshop automation 626
- scrubby sliders 15
- security, PDF files 450
- selecting
 - See also selections, selection borders*
 - channels 493
 - color ranges 253
 - colors from all visible layers 253
 - contiguous pixels 204, 253
 - keyboard shortcuts for 660
 - layers 284
 - layers in a group 284
 - pixels 247
 - RGB colors 117
 - snapshots 50
 - type 411
- selection borders
 - closing 249
 - converting to paths 381
 - defining paths 381
 - for type 432
 - framing with selection 258
 - from paths 380
 - snapping behavior of 38
 - stroking 258
- selections
 - adding to 256
 - adding to channel 274
 - aligning 248
 - anti-aliasing 259
 - contracting 257
 - converting to layer 282
 - copying 262, 263
 - copying while dragging 262
 - creating edge effects with 388
 - creating multiple copies of 262
 - creating with Quick Mask mode 271
 - customizing for Magic Wand tool 253
 - deleting 265
 - deselecting 248
 - dragging between documents 262
 - duplicating 262
 - erasing segments of 249
 - expanding 257, 258
 - extracting 643, 644
 - feathering 259
 - filling 354
 - freehand 249
 - from temporary masks 272
 - hiding and showing edges of 256
 - intersecting 257
 - intersecting in channel 274
 - inverting 256
 - loading 275
 - moving, hiding, or inverting 255
 - pasting 261, 262
 - previewing, using Refine Edge option 258
 - refining edges of 258
 - refining with Color Range command 253
 - removing fringe pixels from 260
 - removing halos around 260
 - replacing in channel 274
 - saving as a mask 274
 - saving to a channel 274
 - selecting similar pixels in 258
 - selecting unselected areas of 256
 - smoothing 258
 - snapping behavior of 38
 - softening edges of 259
 - softening with Color Range command 254
 - stroking 354

- subtracting from 257
- subtracting from channel 274
- tools and commands for making 247
- with straight-edged borders 249
- Selective Color command 183
- Selective color palette 112
- selective sharpening 212
- separations. *See* color separations
- serial numbers. *See* Photoshop legacy serial number
- Shadow/Highlight command 172
- shadows
 - adjusting 172
 - adjusting with Levels 162
- shape dynamics, for brushes 340
- shape layers 359
- Shape tool options 363
- shapes
 - adding to 361
 - distributing 378
 - drawing 360
 - drawing custom 362
 - drawing, with Pen tool 364
 - editing 362
 - intersecting 361
 - multiple on a layer 361
 - overlapping 361
 - rasterizing 362
 - saving custom 362
 - selecting custom 362
 - subtracting from 361
 - wheel 361
- Sharpen Edges filter 394
- Sharpen filter 209, 394
- Sharpen More filter 394
- sharpen selectively 209
- Sharpen tool 205
- sharpening images 209, 210, 211
- Shear filter 392
- shortcuts 648, 649
- Show All Layer Styles command 304
- Show Auto Slice command 500
- Show Channels command 266
- Show Rulers command 36
- Show Slice Number command 500
- sidecar files 99, 100, 464
- Simulate Ink Black option 137
- Simulate Paper White option 137
- Single Column Marquee tool 248
- Single Row Marquee tool 248
- Single-line Composer 428
- Sketch filters 394
- Slice Options dialog box 497
- Slice tool 498
- slices
 - about 497
 - adding links to 505
 - aligning 503
 - auto 497
 - background color of 504
 - badges in 499
 - boundaries of 500
 - changing stacking order of 503
 - color of 499
 - combining 502
 - converting 499
 - converting auto to user 499
 - copying 502
 - creating 498
 - deleting 503
 - duplicating 502
 - export options for 504
 - Image type 504
 - lines 499
 - locking 504
 - modifying 503
 - moving 500
 - No Image type 504
 - numbering of 499
 - renaming 504
 - resizing 500
 - selecting 500
 - slice lines 500
 - snapping to 501
 - specifying browser messages in export options 505
 - types of 497
 - unlocking 504
 - user type 497
 - viewing 499
 - working with in Save For Web 510
- sliders
 - pop-up sliders 15
 - scrubby sliders 15
- Small Caps command 415
- small caps. *See* type, formatting
- Smallest File Size PDF setting 447
- Smart Blur filter 390
- Smart Filters
 - about 313
 - applying 313
 - copying 314
 - deleting 314
 - disabling masks 316
 - duplicating 314
 - editing 314
 - hiding 314
 - masking 315
 - moving 314
 - reordering 314
 - setting blending options 314
- Smart Guides 38
- Smart Highlighting option 644
- Smart Objects
 - about 310
 - converting to layer 313
 - creating 311
 - duplicating 312
 - editing 312
 - exporting 312
 - replacing contents 312
- Smart Sharpen filter 210
- smoothing
 - selection edges 380
 - selections 258
- Smudge Stick filter 389
- Smudge tool 204
- Snap command 40, 248
- Snap Neutral Midtones option of Auto Color 187
- Snapshot command 49
- snapshots
 - clearing 46
 - of state 46
- Soft light mode 347, 348
- soft proofs 160
- soft-proofing
 - about 134
 - in Acrobat 137
 - in Photoshop, Illustrator and InDesign 135
- software
 - activation 1
 - downloads 3
 - registration 1
- Solarize filter 395
- Sort By Hue command 518
- Sort By Luminance command 518

- Sort By Popularity command 518
- spacer cells 525
- Spacing option, brush 339, 343
- spacing, between words and letters. *See* type, formatting
- special characters
 - in OpenType fonts 418
- special effects with filters 388
- spell checking 409
- Spherize filter 392
- Splatter filter 391
- Split Channels command 268
- Sponge filter 389
- Sponge tool 206
- spot channels
 - See also* channels
 - adding 491
 - merging 493
 - options 493
 - saving 441
- spot colors
 - about 491
 - color management considerations 131
 - trapping 494
- Spot Healing Brush tool 197, 201
- Spotlight effect 401
- Sprayed Strokes filter 391
- squares, drawing 356
- sRGB color space 133, 145
- stacking order
 - arranging for slices 503
 - of layers 285
- Stained Glass filter 396
- Stamp filter 395
- standard deviation pixel values 151
- Standard mode button, for turning off quick mask 272
- standard screen mode 27
- status bar
 - about 34
- stops, inserting in recordings 619
- straight quotes. *See* type, formatting
- strikethrough type. *See* type
- Stroke command 356
- Stroke effect 300
- Stroke Path command 356
- strokes, keyboard shortcuts for 661
- stroking
 - selection borders 258
 - selections 354, 356
- styles
 - applying preset 299
 - converting to layers 306
 - copying and pasting in 305
 - preset 299
- Stylize filters 395
- Stylus Pressure option 251
- Subscript command 415
- subslices 498
- Subtract option 278
- Sumi-e filter 391
- Superscript command 415
- SVG (scalable vector graphics)
 - Save For Web command 523
- Swatches panel
 - about 121
 - keyboard shortcuts for 671
 - loading color table into 114
- swatches, sharing between applications 123
- SWF files
 - about 521
- T**
- table slices 497
- tablet, setting pen pressure 346
- Tagged-Image File Format (TIFF). *See* TIFF format
- Targa format 463
- target channel 266
- target values, setting with Levels or Curves 175
- tate-chu-yoko. *See* Asian type
- templates, using with other Adobe applications 632
- text
 - See also* type
 - formatting 415
 - keyboard shortcuts for 662
- text formatting
 - See also* fonts, character styles, paragraph styles
- text on a path 429
- Texture Channel 403
- Texture filters 396
- textures
 - copying between tools 346
 - for brushes 342
 - in Lighting Effects filter 403
 - protecting in brush strokes 345
- Texturizer filter 396, 397
- thaw areas, with Liquify filter 222
- Threshold command 190
- Threshold slider 398
- thumbnails
 - in PDF file 448
 - layer 280
 - resizing in Channels panel 267
 - saving 441
- TIFF format
 - about 463
 - saving files in 452
 - saving in for page layout 468
- Tiles filter 395
- timecode 530
- Timeline
 - navigating 531
 - previewing video and animation 561
- tokens 640
 - syntax of 641
 - using in web photo gallery 641
- tonal and color adjustments
 - about 155
 - Auto Contrast command 186
 - automatic adjustments 185, 186
 - Hue/Saturation command 168
 - made in Curves dialog box 165
 - made with adjustment layers 158
 - Match Color command 179
 - Replace Color command 180
 - saving 159
 - slices 499
 - using tools and commands for 158
- tonal range
 - adjusting with Curves 164, 165
 - checking in histogram 149
 - remapping pixels in channel 190
- tool hotspots 24
- tool pointers 24
- tool presets
 - about 25
 - creating 26
 - panels for 26
- tool tips
 - about 19
 - hiding 13
- tools
 - See also* tool presets, *individual tool names*
 - cycling through 24
 - fill 645
 - keyboard shortcuts for 649
 - layer sampling 283

- painting 328
 - recording in actions 618
 - setting pointer appearance of 24
 - snapping behavior of 38
 - standard and precise cursors in 25
 - viewing current 35
 - viewing hidden 18, 23
 - Tools panel, configuring 8
 - Tools Preset pop-up panel 26
 - top-to-top leading 434
 - Torn Edges filter 395
 - Toyo colors 120
 - Trace Contour filter 395
 - tracking 421
 - Transform command 32
 - transform perspective 192
 - Transform tool, in vanishing point 228
 - transformations
 - applying 214
 - repeating 214
 - selecting an item for 214
 - setting or moving the reference point for 214
 - transforming freely 214
 - transforming
 - duplicating an item while 214
 - duplicating while 217
 - layers 286
 - reference point 216
 - repeating 217
 - selecting items to 215
 - type 406
 - transforming objects
 - from the Edit menu 404
 - with Perspective and Distort commands 404
 - transparency
 - applied with mask 271
 - canvas 196
 - dithering 516
 - gradients 352
 - in documents 283
 - in web graphics 517
 - Transparency & Gamut option 283
 - Trap command 487
 - trapping
 - adjusting overlapping spot colors 494
 - Trim command 193
 - trimming images 193
 - tritones. *See* duotones
 - TrueType fonts 416
 - Trumatch color system 120
 - tryouts 3
 - Tsume option 434
 - TWAIN interface for scanners 647
 - tweening 551
 - animation frames 530
 - Twirl Clockwise tool 223
 - Twirl filter 392
 - type
 - See also* Asian type, fonts, type formatting, type layers
 - about 404
 - adding drop shadow to 432
 - Asian type options 434
 - assigning a language to 410
 - bounding box of 406
 - committing 405
 - creating 405
 - curly and straight quotes in 408
 - editing 407
 - editing hyphenation 427
 - filling 414
 - finding and replacing 409
 - formatting characters 411
 - formatting paragraphs 423
 - formatting through the Character panel 412
 - hanging punctuation 426, 427
 - keyboard shortcuts for 662
 - on a path 429
 - orientation of 411
 - paragraph type 406
 - rasterized 404
 - resizing 406
 - selecting 411
 - selection border around 432
 - setting Asian OpenType font attributes 436
 - size of 413
 - spell-checking 409
 - strikethrough 414
 - style of 415
 - transforming 406
 - underlining or striking through 414
 - unwarping 431
 - work path for 432
 - Type 1 fonts 416
 - type layers
 - about 404
 - anti-aliased 408
 - changing orientation 411
 - rasterizing 411
 - transforming 404
 - unwarping 431
 - Type tool 405
 - type, editing
 - hyphenation 428
 - type, formatting
 - all caps and small caps 415
 - baseline shift 422
 - composition methods 428
 - fonts 416
 - fractional character widths 422
 - kerning and tracking 420, 421
 - keyboard shortcuts for 663
 - missing fonts 417
 - OpenType fonts 418
 - paragraph spacing 426
 - scaling 422
 - spacing between words 425
 - with Paragraph palette 424
 - typeface. *See* fonts
 - typographers' quotes 408
- ## U
- underlining. *See* type
 - Underpainting filter 389, 397
 - Undo command 45
 - Ungroup command 326
 - Uniform color palette 112
 - Unsharp Mask filter 210, 394
 - about 209, 210
 - after resampling 60
 - selective sharpening 212
 - Unshift All Colors command 519
 - unwarping type layers 431
 - updates 3
 - URLs, assigning to slices 505
 - Use Accurate Screens option 490
 - user slices. *See* slices
- ## V
- vanishing point
 - about 228
 - about selections in 228
 - copying selections 228
 - defining and adjusting perspective planes 228
 - exporting measurements, textures, and 3D information 228

- filling selections with another area image 228
 - measuring in 228
 - painting with a color in 228
 - painting with sampled pixels 228
 - pasting an item into 228
 - perspective planes and the grid 228
 - working in 228
 - Vanishing Point dialog box 228
 - variables
 - about 628
 - defining 629
 - Variations command 188
 - varnishes 492
 - vector graphics
 - about 54, 359
 - printing 477
 - SWF (Flash) file format 521
 - type 432
 - Vector Mask Hides Effects option 297
 - vector masks
 - adding 323
 - converting to layer mask 324
 - disabling and enabling 324
 - editing 324
 - removing 324
 - vector shapes, about 359
 - VGA color palette 461
 - video
 - cloning content 541
 - exporting 564
 - previewing in the timeline 561
 - Video filters
 - De-Interlace 396
 - NTSC Colors 396
 - video layers
 - about 280
 - color mode, bit depth 528
 - rasterizing 546
 - removing footage 544
 - Video Preview plug-in 561
 - vignetting, about 207
 - vignetting, correcting in camera raw files 93
 - virtual memory 50
 - Vivid light mode 348
- W**
- Wacom tablet 339
 - warming filters 184
 - warnings, showing and hiding 44
 - Warp command 219
 - Warp tool 223
 - warping an image. *See* images
 - Water Paper filter 395
 - Watercolor filter 389
 - Watermark Durability Setting 467
 - watermarks, embedding 465, 467
 - Wave filter 392
 - WBMP format 464
 - web color palettes 112
 - web file formats
 - GIF and PNG-8 513
 - JPEG 512
 - PNG-24 521
 - web graphics
 - See also specific file formats*
 - color management considerations 133
 - file formats, compared 512
 - generating CSS layers 511
 - optimizing 506
 - output settings 526
 - previewing 512
 - web graphics, color management considerations 134
 - web graphics, optimizing 624
 - web photo galleries
 - creating 638
 - customizing 640
 - options for 639
 - styles 640
 - using tokens in 640, 641
 - Web Shift/Unshift Selected Colors command 519
 - web-safe alert, in Color Picker 116, 117
 - web-safe colors
 - about 118, 514
 - changing to 118
 - selecting in Adobe Color Picker 118
 - selecting in Color panel 118
 - wet edges, or watercolor effect 345
 - white balance for camera raw files 88
 - WIA support 63, 64
 - Wind filter 395
 - windows
 - moving 9
 - Windows (Microsoft)
 - color palette 112
 - color picker 120
 - system color palette 114
 - WMMP optimization options 521
 - word breaks, preventing 428
 - word spacing 425
 - work area
 - about 6
 - work paths
 - about 359
 - converting selection to 381
 - creating 370, 371
 - working spaces, color 144, 145
 - workspaces
 - customizing 12
 - customizing menus in 17
 - deleting menus from 18
 - menu colors in 18
- X**
- XHTML-compliant web pages 524
 - XMP (Extensible Metadata Platform) 464
 - XMP metadata
 - saving with a file 509
 - XMP sidecar files
 - in Camera Raw 99
 - viewing in Adobe Bridge 100
 - XMP Software Development Kit 464
- Z**
- zero origin (rulers) 36
 - ZigZag filter 392
 - ZIP compression 457
 - Zoom tool 32
 - Zoomify 496
 - zooming
 - dragging 29
 - in and out 28